

## Series 581, size 1

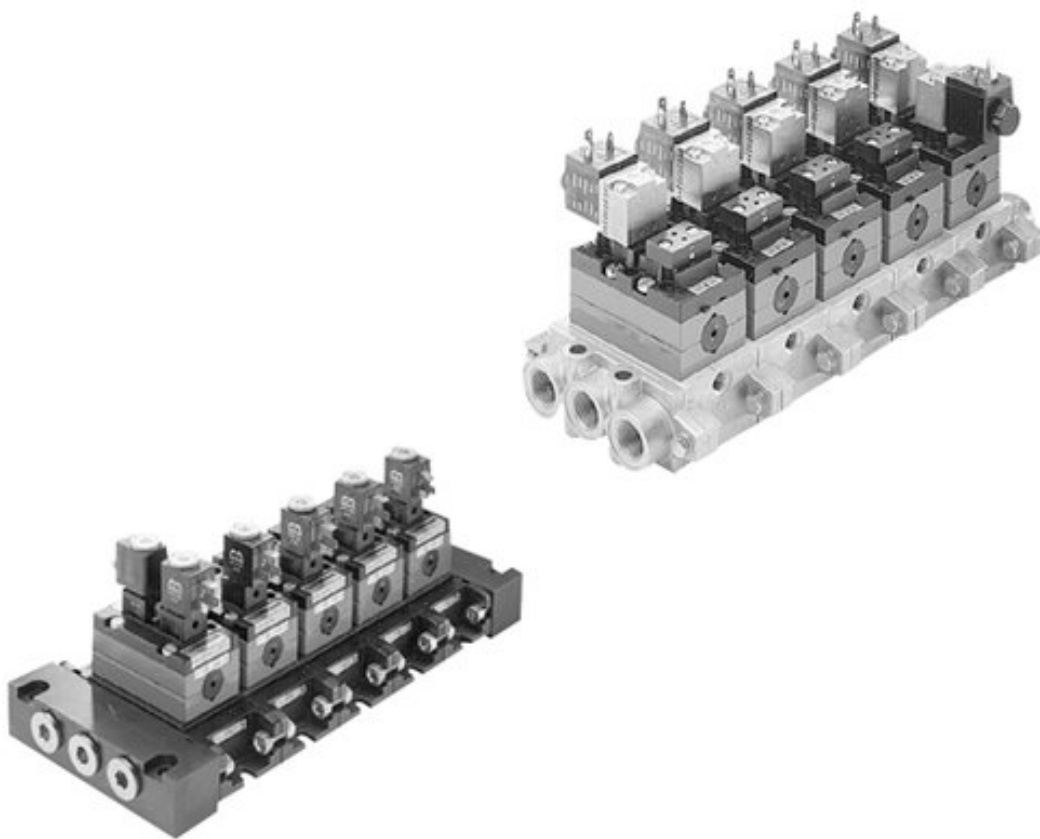

AVENTICS™ Series 581, size 1



# Valve system, Series 581, size 1

- Configurable valve systems

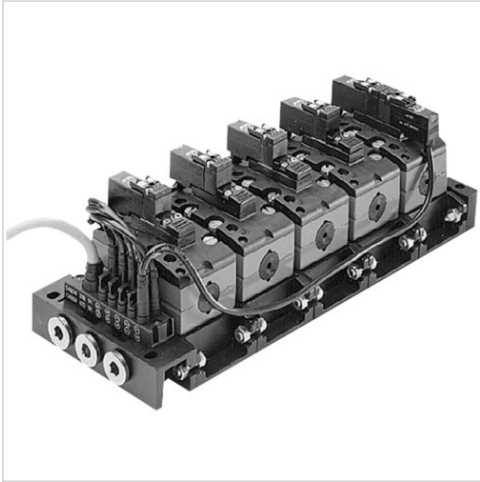

Blocking principle  
 Standards  
 Working pressure min./max.  
 Ambient temperature min./max.  
 Medium  
 Max. particle size  
 Oil content of compressed air  
 Nominal flow Qn  
 Number of valve positions max.  
 Protection class with connection  
 Voltage tolerance DC

Single base plate principle  
 ISO 5599-1, ISO 1  
 -0,95 ... 10 bar  
 -10 ... 50 °C  
 Compressed air  
 50 µm  
 0 ... 5 mg/m<sup>3</sup>  
 1100 l/min  
 10  
 IP65 IP67  
 -10% / +10%

An example configuration is illustrated.  
 The delivered product may thus deviate from the illustration.

## Overview of variants

	Version	You have the following options:
	15 mm pilot valve width	Compressed air connection output Base plate ISO 5599-1 manual override: without detent
	15 mm pilot valve width	Compressed air connection output Base plate ISO 5599-1 Electrical connection Single plug-in wiring electronic connection module and multiple cable manual override: without detent
	22 mm pilot valve width	Compressed air connection output Base plate ISO 5599-1 Electrical connection Single plug-in wiring Valve plug connector form B industry Manual override: with detent
	30 mm CNOMO pilot valve width	Compressed air connection output Base plate ISO 5599-1 Manual override: with detent
	30 mm CNOMO pilot valve width	Compressed air connection output Base plate ISO 5599-1 manual override: without detent
	Pneumatically operated	Compressed air connection output Base plate ISO 5599-1

## Technical information

The min. control pressure must be adhered to, since otherwise faulty switching and valve failure may result!

The pressure dew point must be at least 15 °C under ambient and medium temperature and may not exceed 3 °C .

The oil content of compressed air must remain constant during the life cycle.

Use only the approved oils from AVENTICS. Further information can be found in the "Technical information" document (available in the MediaCentre).

## Technical information

Material	
Plug box	Polyamide fiber-glass reinforced
Seal	Acrylonitrile butadiene rubber

## Dimensions

15 mm pilot valve width, electronic connection module and multiple cable, all ports on bottom

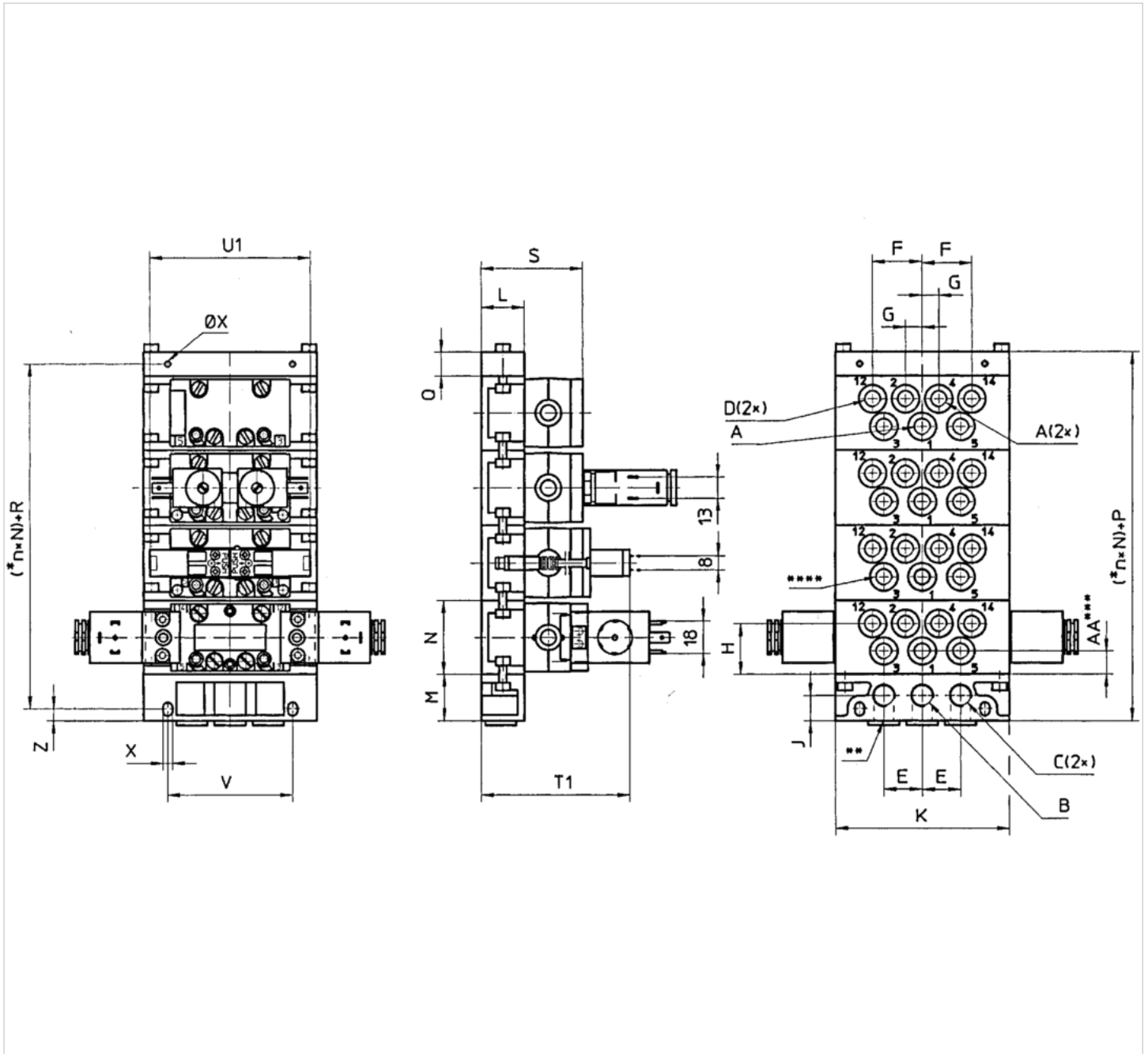

Base plate ISO 5599-1

\* n = number of subbases.

\*\* Alternative port openings, closed with plugs.

\*\*\* Only on subbases with separate intake.

\*\*\*\* Subbase 5801680000 can also be connected to port 3 and 5.

An example configuration is illustrated. The delivered product may thus deviate from the illustration.

## Dimensions

A	G 1/8	G 1/4	Ø 6	Ø 8
B	G 1/4	G 3/8	G 1/4	G 3/8
C	G 1/4	G 3/8	G 1/4	G 3/8



A	G 1/8	G 1/4	Ø 6	Ø 8
D	G 1/8	G 1/8	Ø 4	Ø 6
E	22	27	22	27
F	28.5	40	28.5	40
G	9.5	12.5	9.5	12.5
H	29.5	26.5	29.5	26.5
J	14.5	20	14.5	20
K	100	122	100	122
L	25	30	25	30
M	27	34	27	34
N	43	43	43	43
P (=M+Q)	41	49	41	49
Q	14	15	14	15
R (=Q/2+M-Z)	27.5	34	27.5	34
S	60	65	60	65
V	72	94	72	94
X	5.4	6.4	5.4	6.4
Z	7	8	7	8
AA	8	10	–	–
T1	85	92	85	92
U1	93	93	93	93

A = ports 2 and 4 in the intermediate plate ↔ B = port 1 in the supply plate ↔ C = ports 3 and 5 in the supply plate ↔ D = ports 12 and 14 in the intermediate plate

## Dimensions

Dimensions, ports 2 and 4 on bottom, Ports 12 and 14 on side

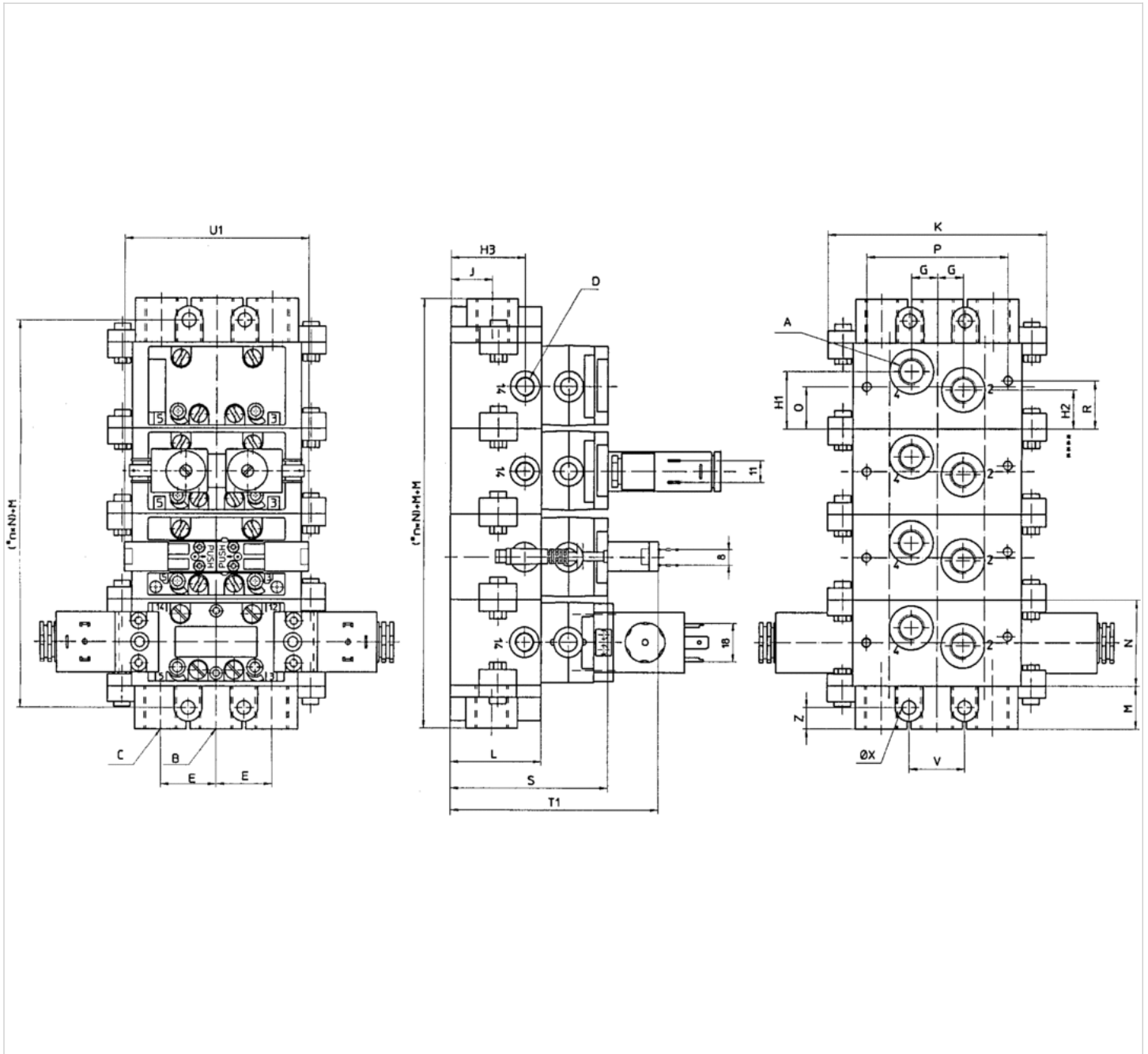

\* n = Number of subbases

An example configuration is illustrated. The delivered product may thus deviate from the illustration.

## Dimensions

A	G 1/4
B	G 3/8
C	G 3/8
D	G 1/8
E	28
G	13

A	G 1/4
H1	29
H2	20
H3	39.5
J	22
K	110
L	46
M	22
N	43
P	71
Q	21.5
R	24.5
S	86
V	28
X	7
Z	11
T1	107
U1	93

## Dimensions

Dimensions, ports 2 and 4 on side, ports 12 and 14 on bottom

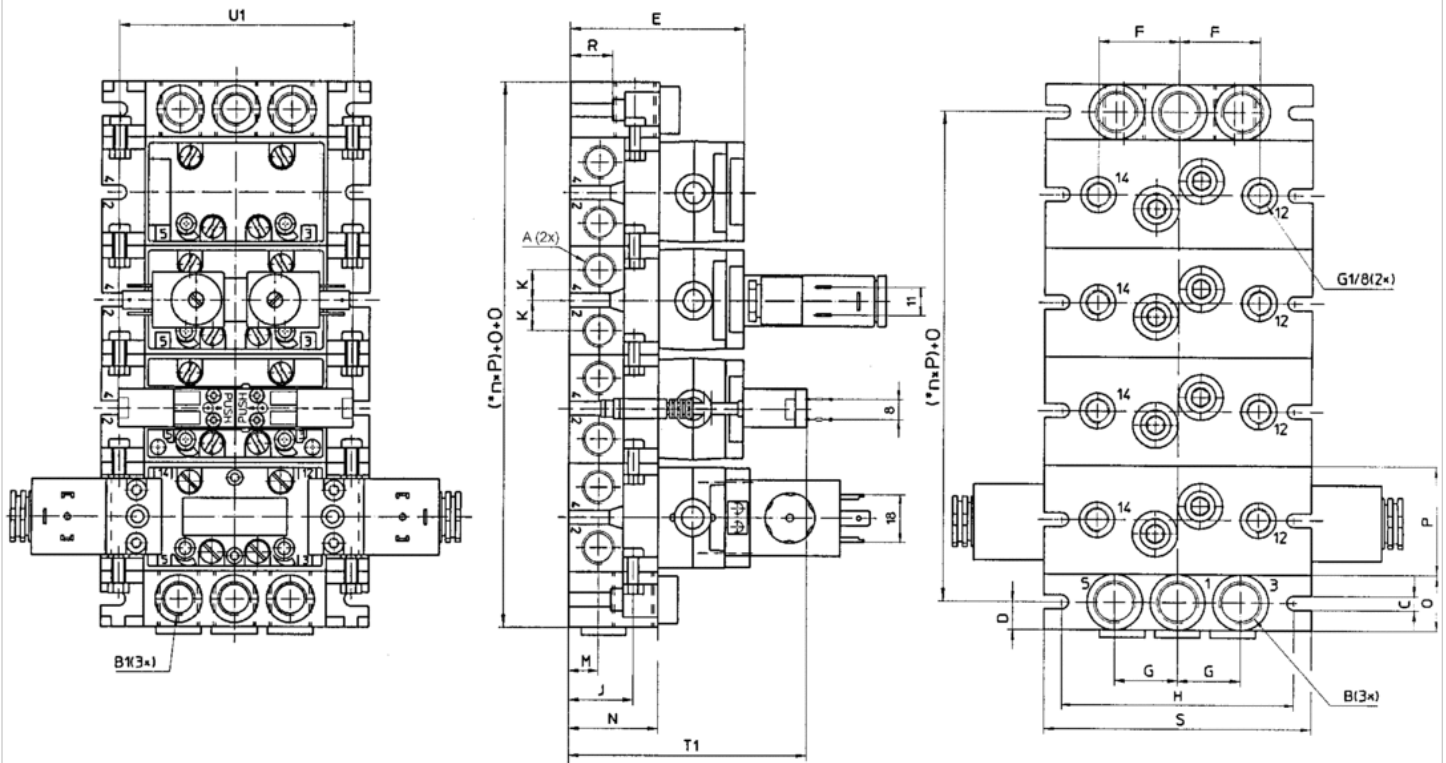

\* n = Number of subbases

An example configuration is illustrated. The delivered product may thus deviate from the illustration.

## Dimensions

A	G 1/4
B	G 3/8
B1	G 1/4
C	5.5
D	11
E	71

A	G 1/4
F	32
G	22
H	92
J	24
R	17
K	12
M	12
N	36
O	22
P	43
S	106
T1	96
U1	93

## Dimensions

22 mm pilot valve width, Valve plug connector without standard (form B industry), all ports on bottom

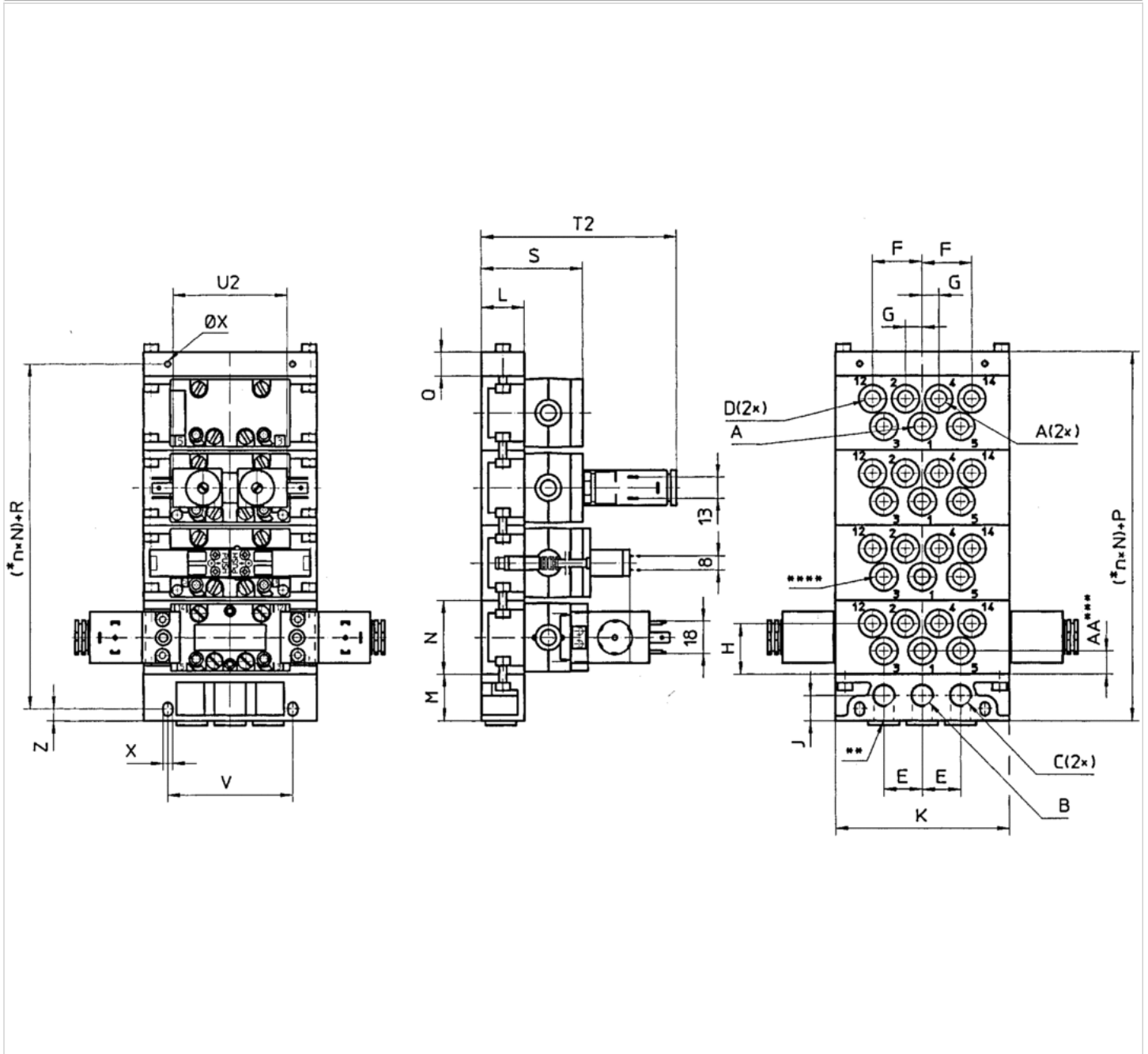

\* n = number of subbases.

\*\* Alternative port openings, closed with plugs.

\*\*\* Only on subbases with separate intake.

\*\*\*\* Subbase 5801680000 can also be connected to port 3 and 5.

An example configuration is illustrated. The delivered product may thus deviate from the illustration.

## Dimensions

A	G 1/8	G 1/4	Ø 6	Ø 8
B	G 1/4	G 3/8	G 1/4	G 3/8
C	G 1/4	G 3/8	G 1/4	G 3/8
D	G 1/8	G 1/8	Ø 4	Ø 6

A	G 1/8	G 1/4	Ø 6	Ø 8
E	22	27	22	27
F	28.5	40	28.5	40
G	9.5	12.5	9.5	12.5
H	29.5	26.5	29.5	26.5
J	14.5	20	14.5	20
K	100	122	100	122
L	25	30	25	30
M	27	34	27	34
N	43	43	43	43
P (=M+Q)	41	49	41	49
Q	14	15	14	15
R (=Q/2+M-Z)	27.5	34	27.5	34
S	60	65	60	65
V	72	94	72	94
X	5.4	6.4	5.4	6.4
Z	7	8	7	8
AA	8	10	–	–
T2	113	119	113	119
U2	70	70	70	70

A = ports 2 and 4 in the intermediate plate ↔ B = port 1 in the supply plate ↔ C = ports 3 and 5 in the supply plate ↔ D = ports 12 and 14 in the intermediate plate

# Dimensions

Dimensions, ports 2 and 4 on bottom, Ports 12 and 14 on side

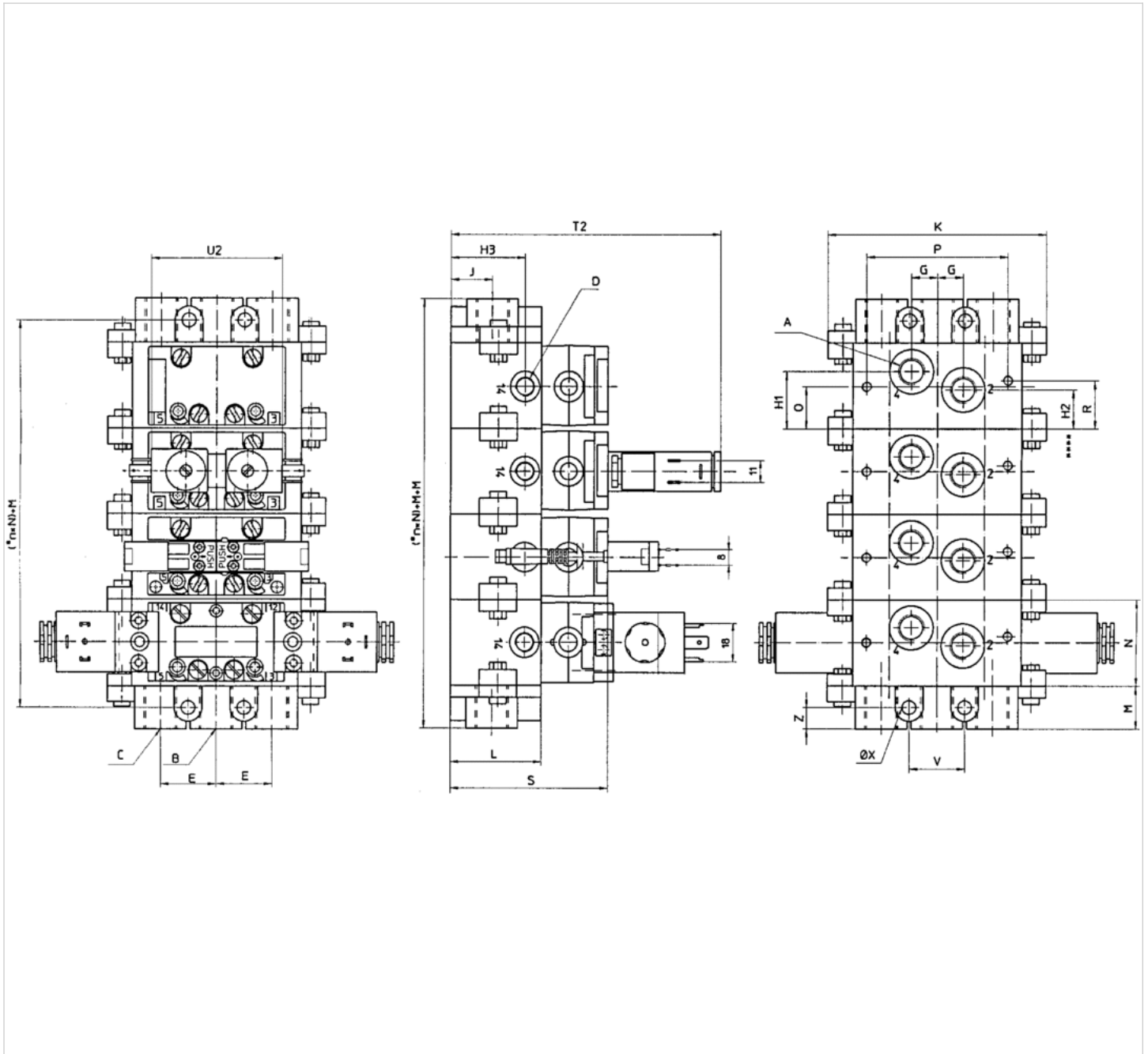

\* n = Number of subbases

An example configuration is illustrated. The delivered product may thus deviate from the illustration.

# Dimensions

A	G 1/4
B	G 3/8
C	G 3/8
D	G 1/8
E	28
G	13



A	G 1/4
H1	29
H2	20
H3	39.5
J	22
K	110
L	46
M	22
N	43
P	71
Q	21.5
R	24.5
S	81
V	28
X	7
Z	11
T2	134
U2	68

## Dimensions

Dimensions, ports 2 and 4 on side, ports 12 and 14 on bottom

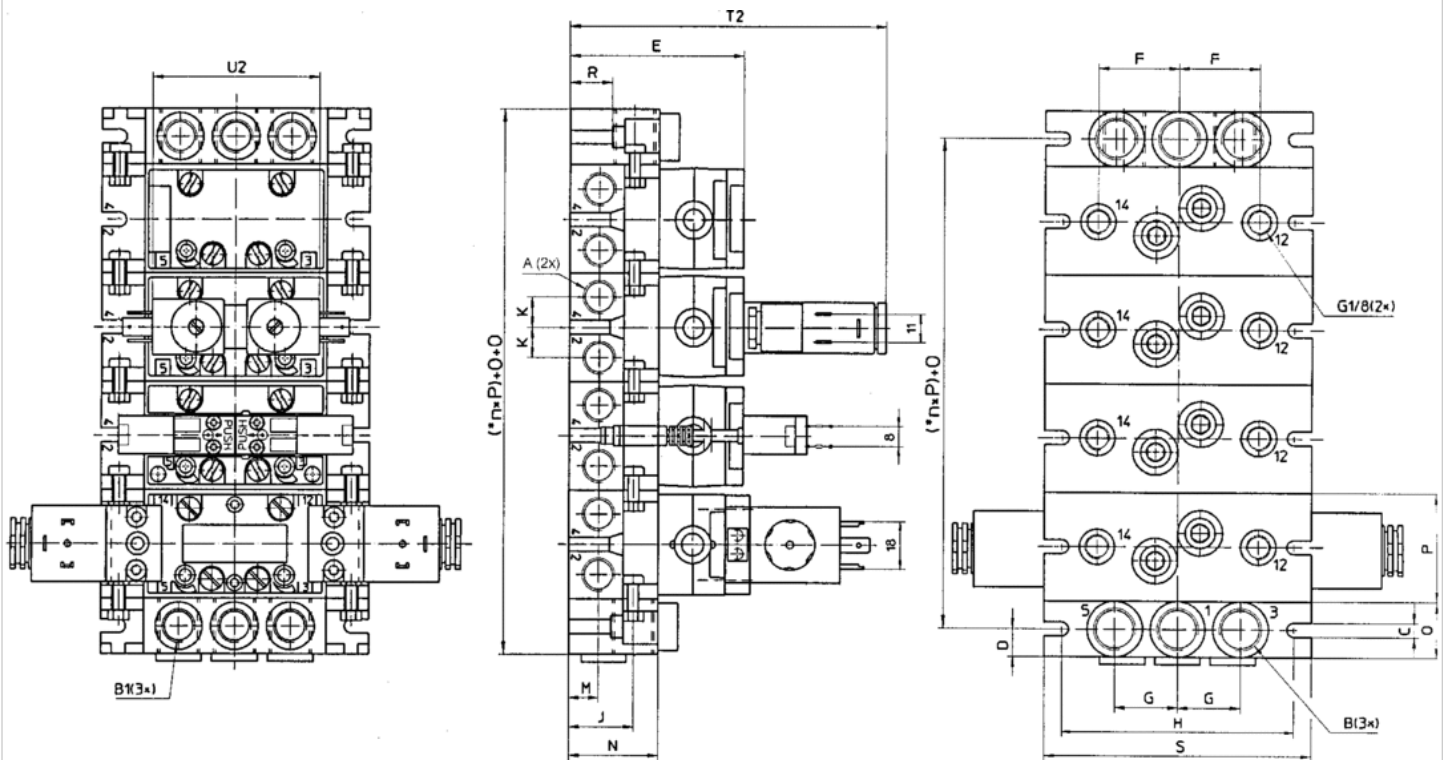

\* n = Number of subbases

An example configuration is illustrated. The delivered product may thus deviate from the illustration.

## Dimensions

A	G 1/4
B	G 3/8
B1	G 1/4
C	5.5
D	11
E	71

A	G 1/4
F	32
G	22
H	92
J	24
R	17
K	12
M	12
N	36
O	22
P	43
S	106
T2	124
U2	70

## Dimensions

30 mm CNOMO pilot valve width, all ports on bottom

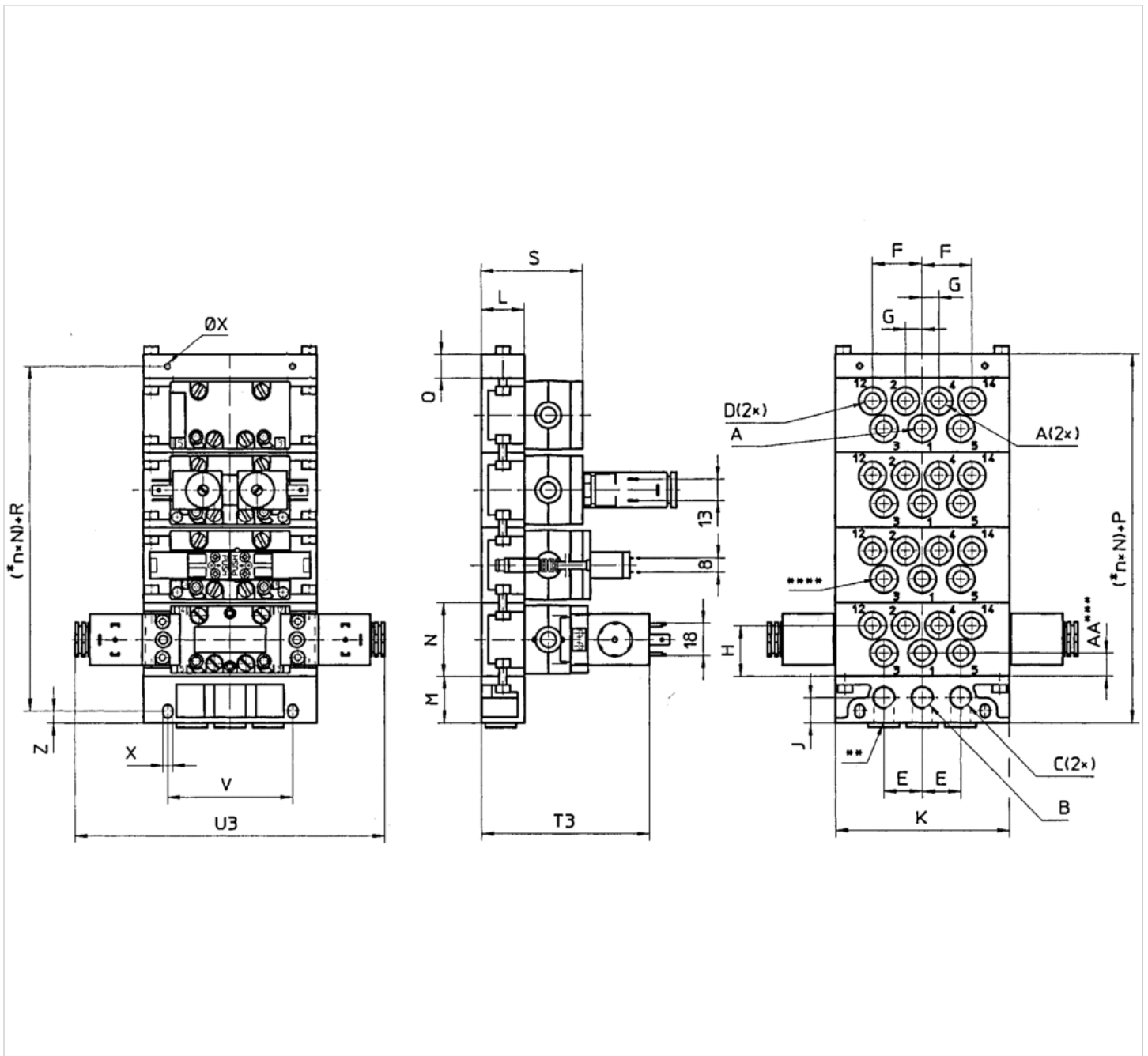

Base plate ISO 5599-1

\* n = number of subbases.

\*\* Alternative port openings, closed with plugs.

\*\*\* Only on subbases with separate intake.

\*\*\*\* Subbase 5801680000 can also be connected to port 3 and 5.

An example configuration is illustrated. The delivered product may thus deviate from the illustration.

## Dimensions

	A	G 1/8	G 1/4	Ø 6	Ø 8
B		G 1/4	G 3/8	G 1/4	G 3/8
C		G 1/4	G 3/8	G 1/4	G 3/8

A	G 1/8	G 1/4	Ø 6	Ø 8
D	G 1/8	G 1/8	Ø 4	Ø 6
E	22	27	22	27
F	28.5	40	28.5	40
G	9.5	12.5	9.5	12.5
H	29.5	26.5	29.5	26.5
J	14.5	20	14.5	20
K	100	122	100	122
L	25	30	25	30
M	27	34	27	34
N	43	43	43	43
P (=M+Q)	41	49	41	49
Q	14	15	14	15
R (=Q/2+M-Z)	27.5	34	27.5	34
S	60	64	60	64
V	72	94	72	94
X	5.4	6.4	5.4	6.4
Z	7	8	7	8
AA	8	10	–	–
T3	100	101	100	101
U3	174	174	174	174

A = ports 2 and 4 in the intermediate plate ↔ B = port 1 in the supply plate ↔ C = ports 3 and 5 in the supply plate ↔ D = ports 12 and 14 in the intermediate plate

## Dimensions

Dimensions, ports 2 and 4 on bottom, Ports 12 and 14 on side

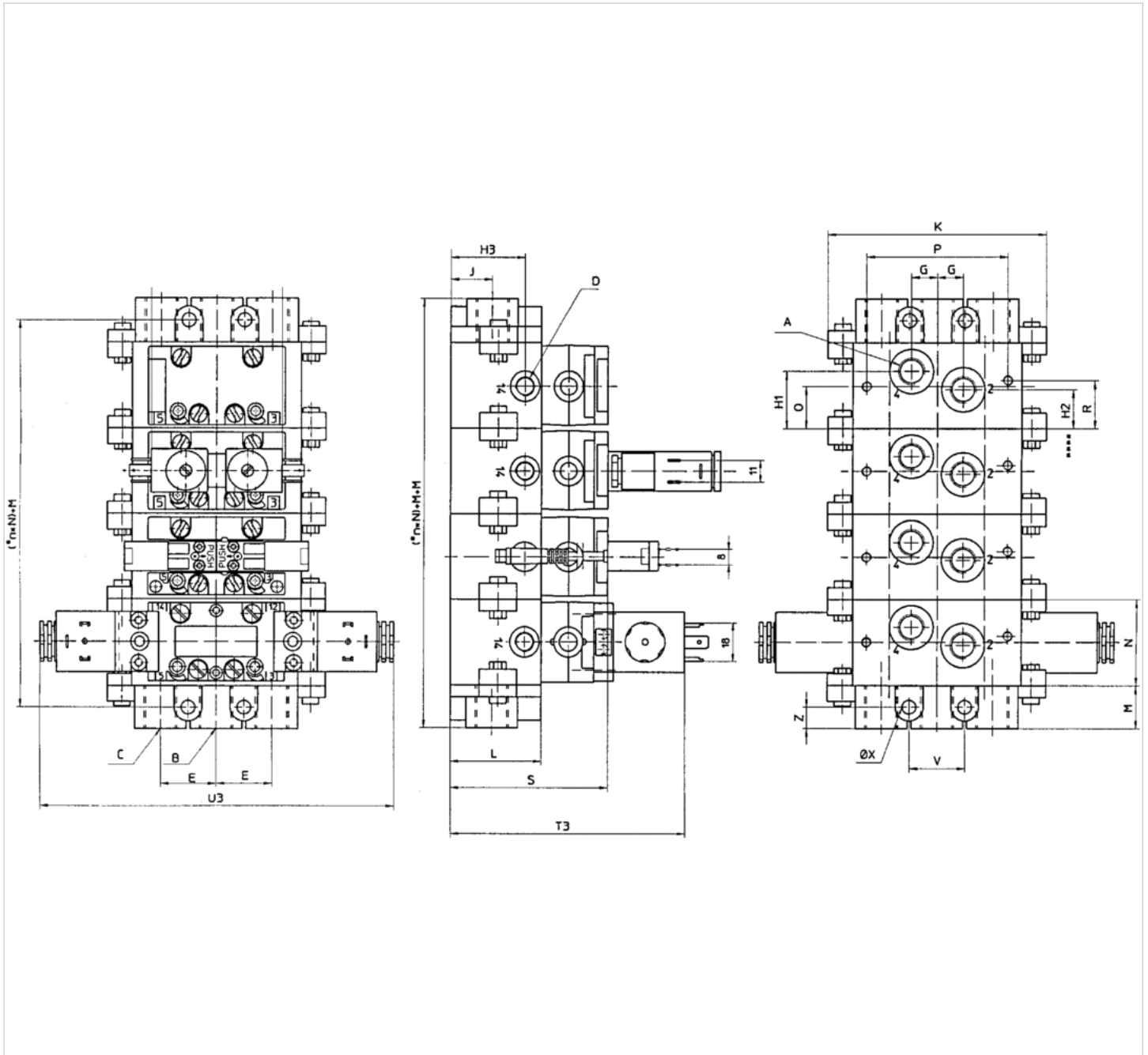

\* n = Number of subbases

An example configuration is illustrated. The delivered product may thus deviate from the illustration.

## Dimensions

A	G 1/4
B	G 3/8
C	G 3/8
D	G 1/8
E	28
G	13

A	G 1/4
H1	29
H2	20
H3	39.5
J	22
K	110
L	46
M	22
N	43
P	71
Q	21.5
R	24.5
S	81
V	28
X	7
Z	11
T3	121
U3	174

## Dimensions

Dimensions, ports 2 and 4 on side, ports 12 and 14 on bottom

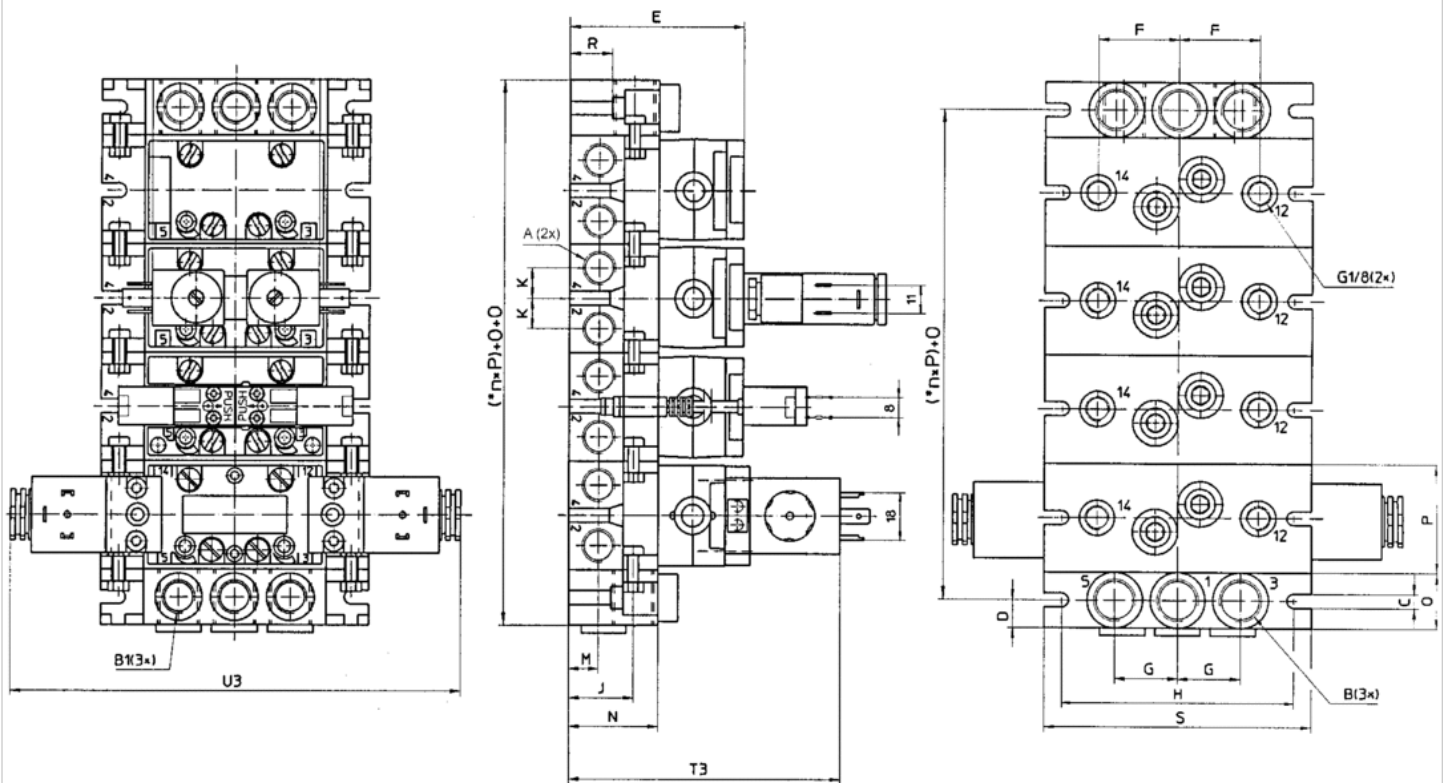

\* n = Number of subbases

An example configuration is illustrated. The delivered product may thus deviate from the illustration.

## Dimensions

A	G 1/4
B	G 3/8
B1	G 1/4
C	5.5
D	11
E	71



A	G 1/4
F	32
G	22
H	92
J	24
R	17
K	12
M	12
N	36
O	22
P	43
S	106
T3	111
U3	174

## Dimensions

Pneumatically operated, all ports on bottom

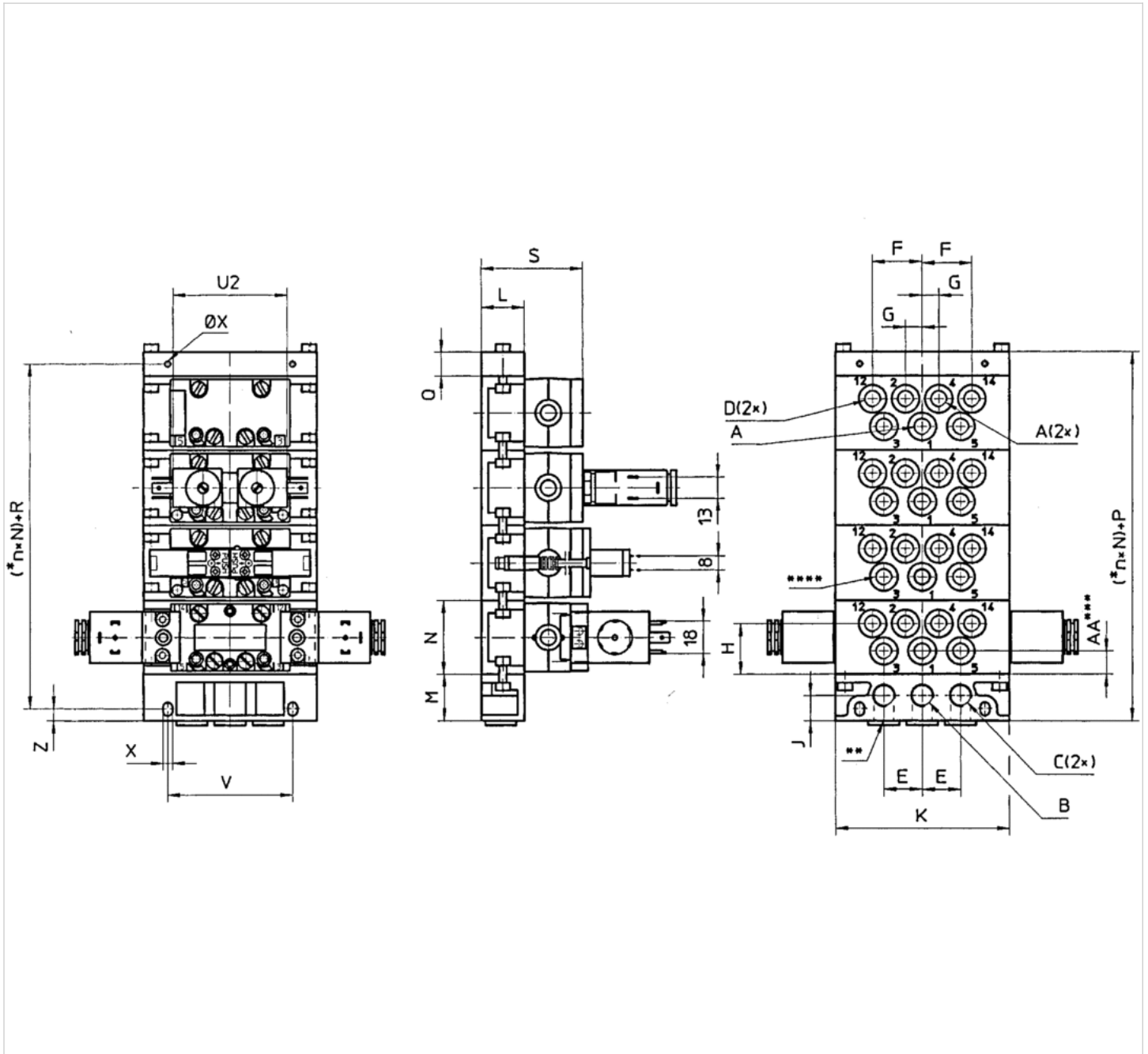

\* n = number of subbases.

\*\* Alternative port openings, closed with plugs.

\*\*\* Only on subbases with separate intake.

\*\*\*\* Subbase 5801680000 can also be connected to port 3 and 5.

An example configuration is illustrated. The delivered product may thus deviate from the illustration.

## Dimensions

A	G 1/8	G 1/4	Ø 6	Ø 8
B	G 1/4	G 3/8	G 1/4	G 3/8
C	G 1/4	G 3/8	G 1/4	G 3/8
D	G 1/8	G 1/8	Ø 4	Ø 6

A	G 1/8	G 1/4	Ø 6	Ø 8
E	22	27	22	27
F	28.5	40	28.5	40
G	9.5	12.5	9.5	12.5
H	29.5	26.5	29.5	26.5
J	14.5	20	14.5	20
K	100	122	100	122
L	25	30	25	30
M	27	34	27	34
N	43	43	43	43
P (=M+Q)	41	49	41	49
Q	14	15	14	15
R (=Q/2+M-Z)	27.5	34	27.5	34
S	60	65	60	65
V	72	94	72	94
X	5.4	6.4	5.4	6.4
Z	7	8	7	8
AA	8	10	-	-
U2	70	70	70	70

A = ports 2 and 4 in the intermediate plate ↔ B = port 1 in the supply plate ↔ C = ports 3 and 5 in the supply plate ↔ D = ports 12 and 14 in the intermediate plate

## Dimensions

Dimensions, ports 2 and 4 on bottom, Ports 12 and 14 on side

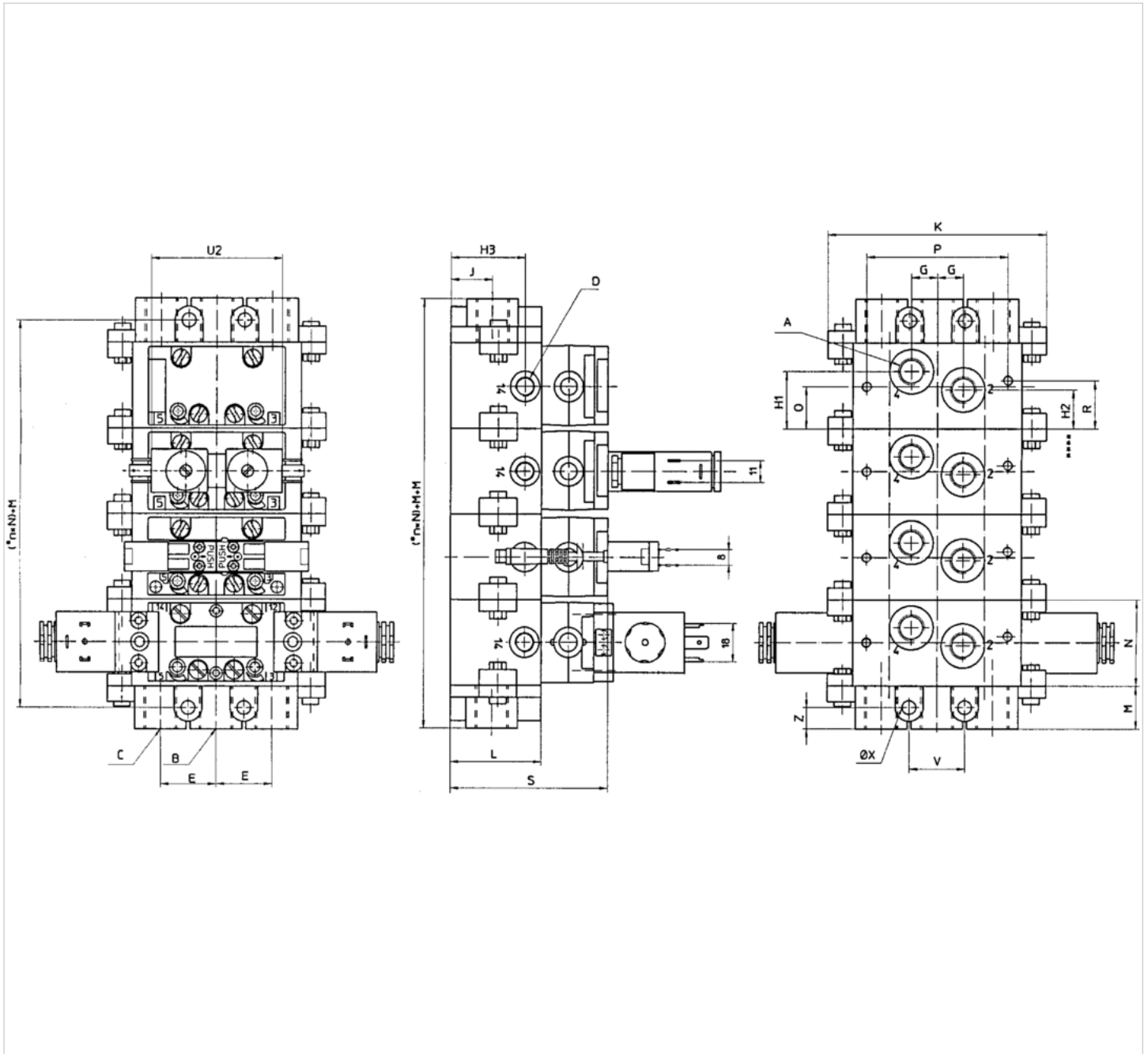

\* n = Number of subbases

An example configuration is illustrated. The delivered product may thus deviate from the illustration.

## Dimensions

A	G 1/4
B	G 3/8
C	G 3/8
D	G 1/8
E	28
G	13

A	G 1/4
H1	29
H2	20
H3	39.5
J	22
K	110
L	46
M	22
N	43
P	71
Q	21.5
R	24.5
S	81
V	28
X	7
Z	11
U2	70

## Dimensions

Dimensions, ports 2 and 4 on side, ports 12 and 14 on bottom

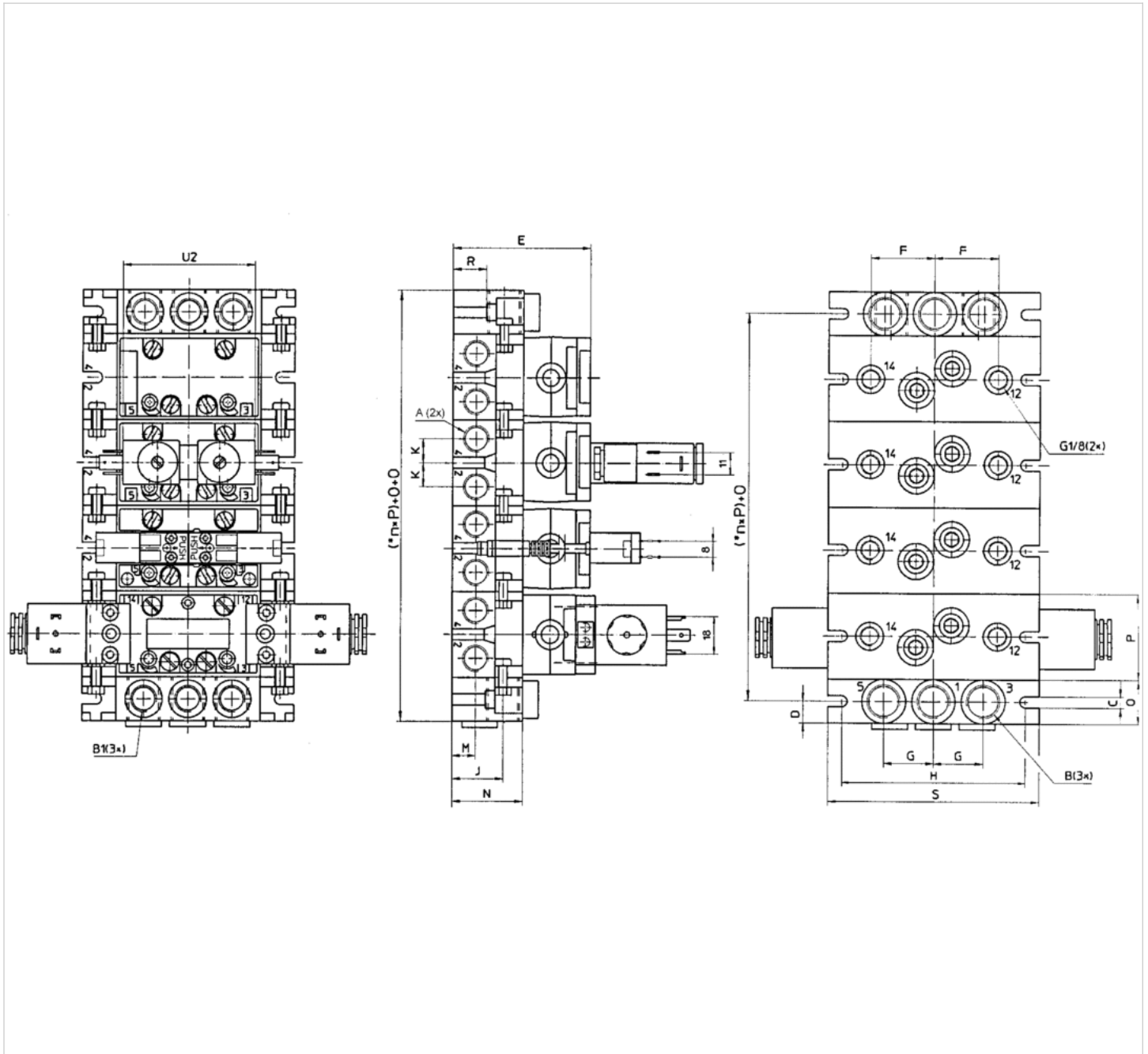

\* n = Number of subbases

An example configuration is illustrated. The delivered product may thus deviate from the illustration.

## Dimensions

A	G 1/4
B	G 3/8
B1	G 1/4
C	5.5
D	11
E	71

A	G 1/4
F	32
G	22
H	92
J	24
R	17
K	12
M	12
N	36
O	22
P	43
S	106
U2	70

# 2x3/2-directional valve, Series 581, size 1

- ISO 5599-1
- ISO 1
- 2x3/2
- NC/NC
- Qn = 950 l/min
- Compressed air connection output Base plate ISO 5599-1
- Electrical connection Plug, ISO 15217, form C
- Manual override without detent

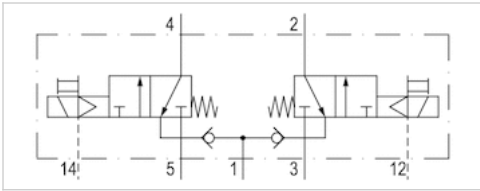

Type	Spool valve
Pilot	External
Sealing principle	Soft sealing
Blocking principle	Single base plate principle
Connection type	Plate connection
Standards	ISO 5599-1, ISO 1
Working pressure min./max.	0 ... 8 bar
Control pressure min./max.	3,5 ... 8 bar
Ambient temperature min./max.	-10 ... 50 °C
Medium temperature min./max.	-10 ... 50 °C
Medium	Compressed air
Max. particle size	50 µm
Oil content of compressed air	0 ... 5 mg/m <sup>3</sup>
Nominal flow Qn	950 l/min
Flow conductance C	3,2 l/(s*bar)
Protection class with connection	IP65
Duty cycle	100 %
Typ. switch-on time	15 ms
Typ. switch-off time	22 ms
Mounting screw	with hexagon socket
Mounting screw tightening torque	2 Nm
Weight	0,22 kg

## Technical data

Part No.	MO		Operational voltage DC	Voltage tolerance DC
R402003702		NC/NC	24 V	-10% / +10%

Part No.	Power consumption DC	Electrical connection Pilot valve
R402003702	2 W	Plug ISO 15217, form C

Connection 12 must be connected with atmospheres, The valve must be supplied with compressed air via ports 3 and 5, Nominal flow Qn at 6 bar and  $\Delta p = 1$  bar, MO = Manual override



## Technical information

The min. control pressure must be adhered to, since otherwise faulty switching and valve failure may result!

The pressure dew point must be at least 15 °C under ambient and medium temperature and may not exceed 3 °C .

The oil content of compressed air must remain constant during the life cycle.

Use only the approved oils from AVENTICS. Further information can be found in the "Technical information" document (available in the MediaCentre).

## Technical information

Housing	Polyamide fiber-glass reinforced
Seals	Acrylonitrile butadiene rubber

## Dimensions

### Dimensions

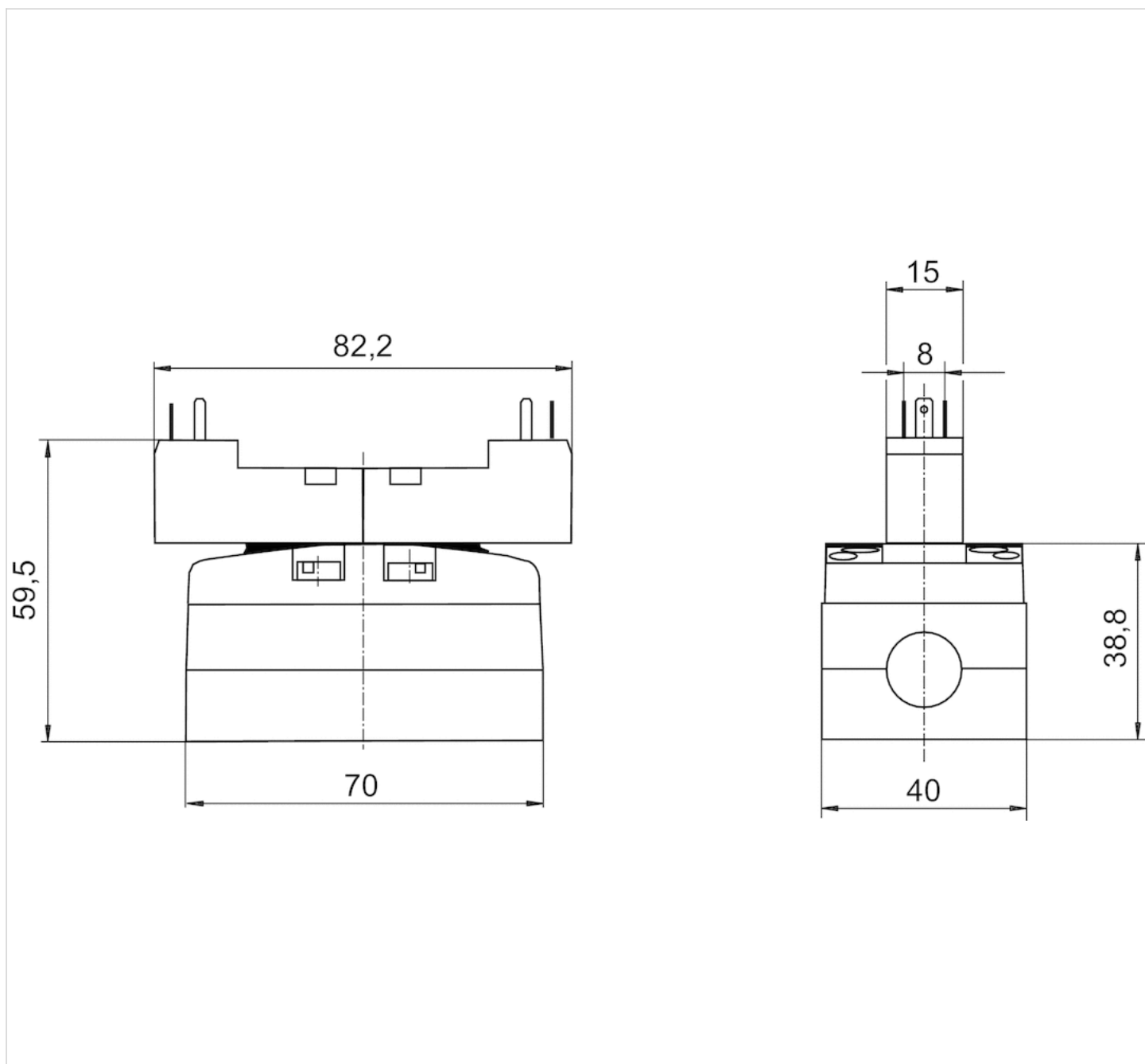









# 5/2-directional valve, Series 581, size 1

- ISO 5599-1
- ISO 1
- 5/2
- With spring return
- single solenoid
- $Q_n = 1400 \text{ l/min}$
- Compressed air connection output Base plate ISO 5599-1
- Electrical connection Plug, ISO 15217, form C
- Manual override without detent



Type	Spool valve
Sealing principle	Soft sealing
Blocking principle	Single base plate principle
Connection type	Plate connection
Standards	ISO 5599-1, ISO 1
Working pressure min./max.	See table below
Control pressure min./max.	3 ... 10 bar
Ambient temperature min./max.	-10 ... 50 °C
Medium temperature min./max.	-10 ... 50 °C
Medium	Compressed air
Max. particle size	50 µm
Oil content of compressed air	0 ... 5 mg/m <sup>3</sup>
Nominal flow $Q_n$	1400 l/min
Flow conductance C	5,2 l/(s*bar)
Protection class with connection	IP65
Duty cycle	100 %
Typ. switch-on time	15 ms
Typ. switch-off time	30 ms
Mounting screw	with hexagon socket
Mounting screw tightening torque	2 Nm
Weight	0,18 kg

## Technical data

Part No.		MO	Operational voltage DC	Voltage tolerance DC
5811150130			24 V	-10% / +10%
5811151130			24 V	-10% / +10%
5811152130			24 V	-10% / +10%
5811153130			24 V	-10% / +10%

Part No.	Power consumption DC	Pilot	Working pressure min./max.
5811150130	2 W	Internal	3 ... 10 bar
5811151130	2 W	Internal	3 ... 10 bar
5811152130	2 W	External	-0,95 ... 10 bar
5811153130	2 W	External	-0,95 ... 10 bar

Part No.	Electrical connection Pilot valve	Throttle
5811150130	Plug ISO 15217, form C	-
5811151130	Plug ISO 15217, form C	with throttle
5811152130	Plug ISO 15217, form C	-
5811153130	Plug ISO 15217, form C	with throttle

Connection 12 must be connected with atmospheres, Nominal flow Qn at 6 bar and  $\Delta p = 1$  bar, MO = Manual override

## Technical information

The min. control pressure must be adhered to, since otherwise faulty switching and valve failure may result!  
 The pressure dew point must be at least 15 °C under ambient and medium temperature and may not exceed 3 °C .  
 The oil content of compressed air must remain constant during the life cycle.  
 Use only the approved oils from AVENTICS. Further information can be found in the "Technical information" document (available in the MediaCentre).

## Technical information

Housing	Polyamide fiber-glass reinforced
Seals	Acrylonitrile butadiene rubber

## Dimensions

### Dimensions

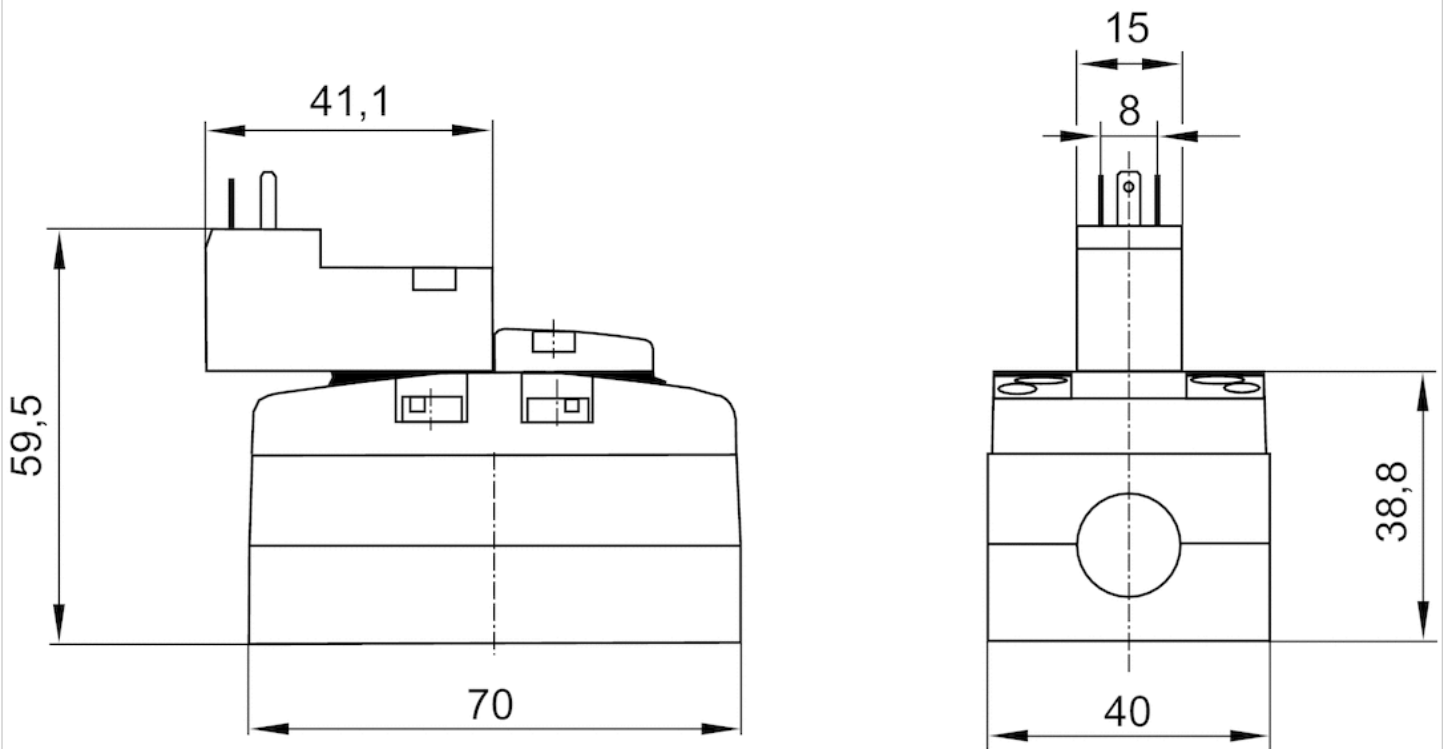









# 5/2-directional valve, Series 581, size 1

- ISO 5599-1
- ISO 1
- 5/2
- double solenoid
- $Q_n = 1400$  l/min
- Compressed air connection output Base plate ISO 5599-1
- Electrical connection Plug, ISO 15217, form C
- Manual override without detent



Type	Spool valve
Sealing principle	Soft sealing
Blocking principle	Single base plate principle
Connection type	Plate connection
Standards	ISO 5599-1, ISO 1
Working pressure min./max.	See table below
Control pressure min./max.	1,5 ... 10 bar
Ambient temperature min./max.	-10 ... 50 °C
Medium temperature min./max.	-10 ... 50 °C
Medium	Compressed air
Max. particle size	50 µm
Oil content of compressed air	0 ... 5 mg/m <sup>3</sup>
Nominal flow $Q_n$	1400 l/min
Flow conductance C	5,2 l/(s*bar)
Protection class with connection	IP65
Duty cycle	100 %
Typ. switch-on time	14 ms
Typ. switch-off time	14 ms
Mounting screw	with hexagon socket
Mounting screw tightening torque	2 Nm
Weight	0,22 kg

## Technical data

Part No.		MO	Operational voltage DC	Voltage tolerance DC
5811260130			24 V	-10% / +10%
5811261130			24 V	-10% / +10%
5811262130			24 V	-10% / +10%
5811263130			24 V	-10% / +10%

Part No.	Power consumption DC	Pilot	Working pressure min./max.
5811260130	2 W	Internal	1,5 ... 10 bar
5811261130	2 W	Internal	1,5 ... 10 bar
5811262130	2 W	External	-0,95 ... 10 bar
5811263130	2 W	External	-0,95 ... 10 bar

Part No.	Electrical connection Pilot valve	Throttle
5811260130	Plug ISO 15217, form C	-
5811261130	Plug ISO 15217, form C	with throttle
5811262130	Plug ISO 15217, form C	-
5811263130	Plug ISO 15217, form C	with throttle

Connection 12 must be connected with atmospheres, Nominal flow Qn at 6 bar and  $\Delta p = 1$  bar, MO = Manual override

MO = Manual override

## Technical information

The min. control pressure must be adhered to, since otherwise faulty switching and valve failure may result!

The pressure dew point must be at least 15 °C under ambient and medium temperature and may not exceed 3 °C .

The oil content of compressed air must remain constant during the life cycle.

Use only the approved oils from AVENTICS. Further information can be found in the "Technical information" document (available in the MediaCentre).

## Technical information

Housing	Polyamide fiber-glass reinforced
Seals	Acrylonitrile butadiene rubber

## Dimensions

### Dimensions

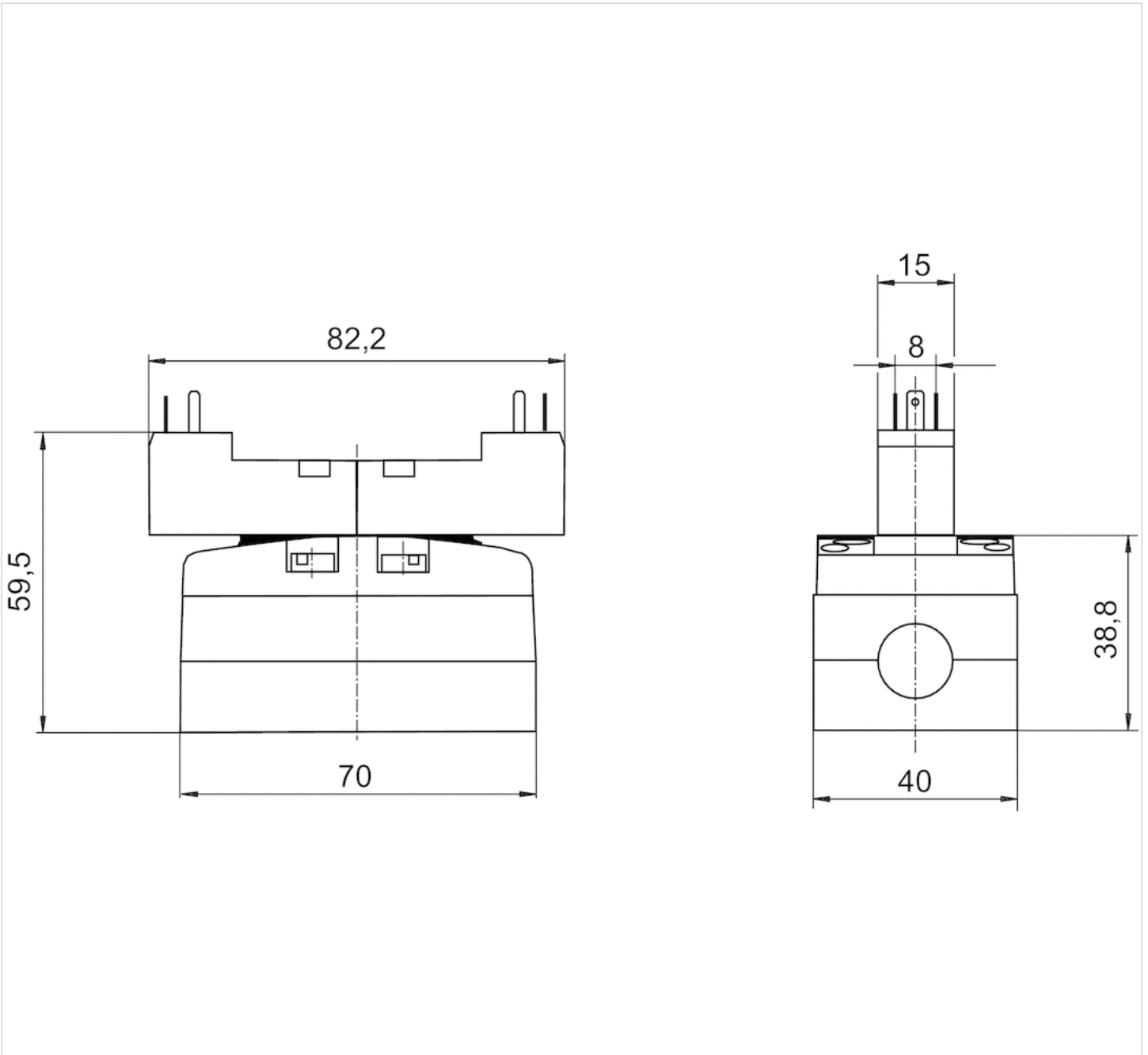



























# 5/3-directional valve, Series 581, size 1

- ISO 5599-1
- ISO 1
- 5/3
- closed center exhausted center pressurized center
- $Q_n = 1100$  l/min
- Compressed air connection output Base plate ISO 5599-1
- Electrical connection Plug, ISO 15217, form C
- Manual override without detent



Type	Spool valve
Sealing principle	Soft sealing
Blocking principle	Single base plate principle
Connection type	Plate connection
Standards	ISO 5599-1, ISO 1
Working pressure min./max.	See table below
Control pressure min./max.	3 ... 10 bar
Ambient temperature min./max.	-10 ... 50 °C
Medium temperature min./max.	-10 ... 50 °C
Medium	Compressed air
Max. particle size	50 µm
Oil content of compressed air	0 ... 5 mg/m <sup>3</sup>
Nominal flow $Q_n$	1100 l/min
Flow conductance C	4,3 l/(s*bar)
Protection class with connection	IP65
Duty cycle	100 %
Typ. switch-on time	14 ms
Typ. switch-off time	22 ms
Mounting screw	with hexagon socket
Mounting screw tightening torque	2 Nm
Weight	0,22 kg

## Technical data

Part No.		MO		Operational voltage DC
5811460130			closed center	24 V
5811461130			closed center	24 V
5811462130			closed center	24 V
5811463130			closed center	24 V
5811560130			exhausted center	24 V
5811561130			exhausted center	24 V
5811562130			exhausted center	24 V
5811563130			exhausted center	24 V
5811760130			pressurized center	24 V
5811761130			pressurized center	24 V
5811762130			pressurized center	24 V
5811763130			pressurized center	24 V

Part No.	Voltage tolerance DC	Power consumption DC	Pilot	Working pressure min./max.
5811460130	-10% / +10%	2 W	Internal	3 ... 10 bar
5811461130	-10% / +10%	2 W	Internal	3 ... 10 bar
5811462130	-10% / +10%	2 W	External	-0,95 ... 10 bar
5811463130	-10% / +10%	2 W	External	-0,95 ... 10 bar
5811560130	-10% / +10%	2 W	Internal	3 ... 10 bar
5811561130	-10% / +10%	2 W	Internal	3 ... 10 bar
5811562130	-10% / +10%	2 W	External	-0,95 ... 10 bar
5811563130	-10% / +10%	2 W	External	-0,95 ... 10 bar
5811760130	-10% / +10%	2 W	Internal	3 ... 10 bar
5811761130	-10% / +10%	2 W	Internal	3 ... 10 bar
5811762130	-10% / +10%	2 W	External	-0,95 ... 10 bar
5811763130	-10% / +10%	2 W	External	-0,95 ... 10 bar

Part No.	Electrical connection Pilot valve	Throttle
5811460130	Plug ISO 15217, form C	-
5811461130	Plug ISO 15217, form C	with throttle
5811462130	Plug ISO 15217, form C	-
5811463130	Plug ISO 15217, form C	with throttle
5811560130	Plug ISO 15217, form C	-
5811561130	Plug ISO 15217, form C	with throttle
5811562130	Plug ISO 15217, form C	-
5811563130	Plug ISO 15217, form C	with throttle
5811760130	Plug ISO 15217, form C	-
5811761130	Plug ISO 15217, form C	with throttle
5811762130	Plug ISO 15217, form C	-
5811763130	Plug ISO 15217, form C	with throttle

Connection 12 must be connected with atmospheres, Nominal flow Qn at 6 bar and  $\Delta p = 1$  bar, MO = Manual override

## Technical information

The min. control pressure must be adhered to, since otherwise faulty switching and valve failure may result!

The pressure dew point must be at least 15 °C under ambient and medium temperature and may not exceed 3 °C .

The oil content of compressed air must remain constant during the life cycle.

Use only the approved oils from AVENTICS. Further information can be found in the "Technical information" document (available in the MediaCentre).

## Technical information

Housing	Polyamide fiber-glass reinforced
Seals	Acrylonitrile butadiene rubber

## Dimensions

### Dimensions

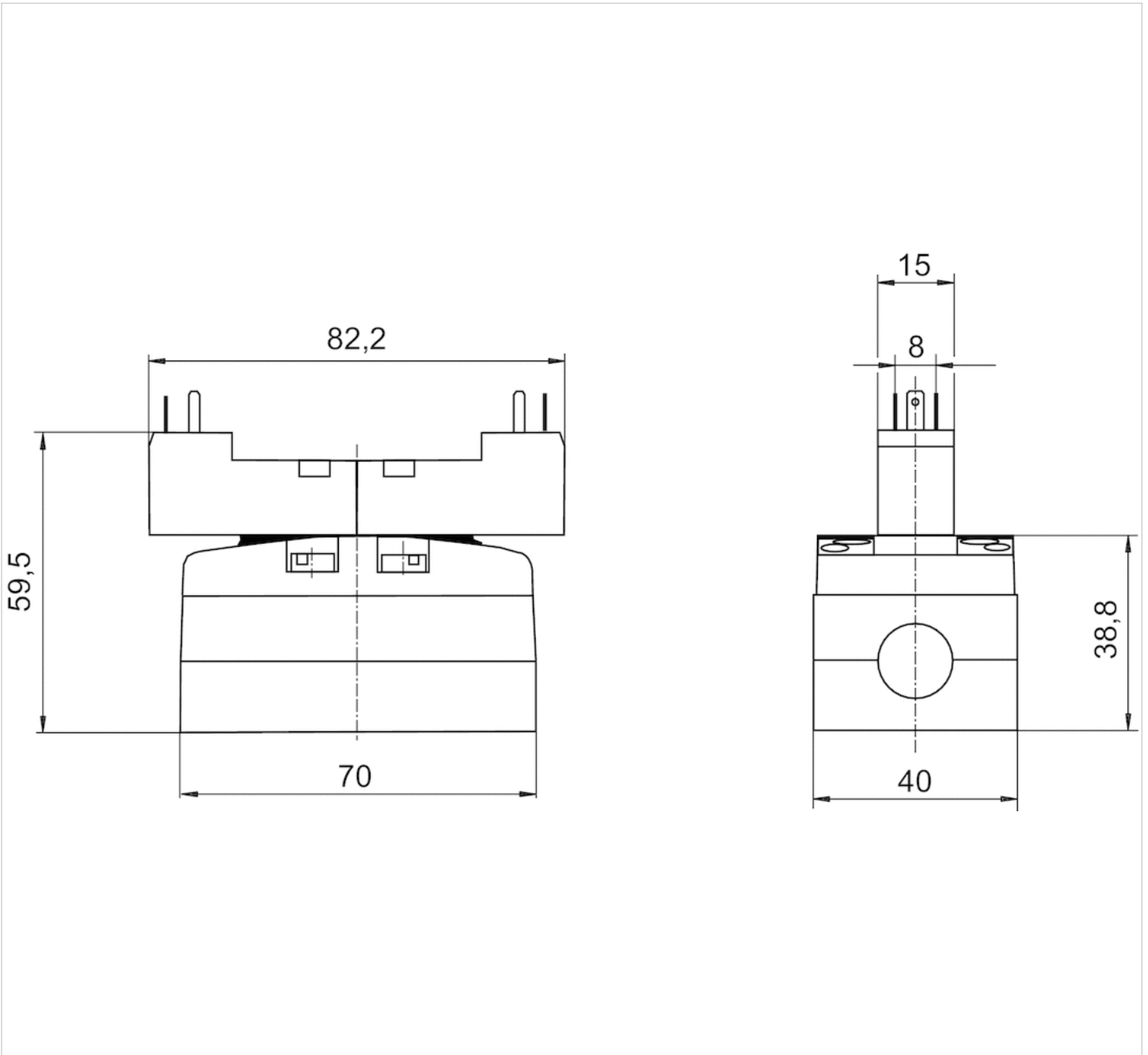

# 2x3/2-directional valve, Series 581, size 1

- ISO 5599-1
- ISO 1
- 2x3/2
- NC/NC
- Qn = 950 l/min
- Compressed air connection output Base plate ISO 5599-1
- Electrical connection Plug, 3-pin
- Manual override without detent

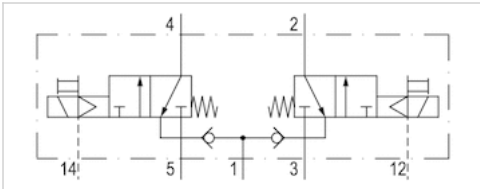

Type	Spool valve
Pilot	External
Sealing principle	Soft sealing
Blocking principle	Single base plate principle
Connection type	Plate connection
Standards	ISO 5599-1, ISO 1
Working pressure min./max.	0 ... 8 bar
Control pressure min./max.	3,5 ... 8 bar
Ambient temperature min./max.	-10 ... 50 °C
Medium temperature min./max.	-10 ... 50 °C
Medium	Compressed air
Max. particle size	50 µm
Oil content of compressed air	0 ... 5 mg/m <sup>3</sup>
Nominal flow Qn	950 l/min
Flow conductance C	3,2 l/(s*bar)
Protection class with connection	IP67
Protective circuit	Z-diode
Reverse polarity protection	Protected against polarity reversal
LED status display	Green
Duty cycle	100 %
Typ. switch-on time	15 ms
Typ. switch-off time	22 ms
Mounting screw	with hexagon socket
Mounting screw tightening torque	2 Nm
Weight	0,22 kg

## Technical data

Part No.	MO		Operational voltage DC	Voltage tolerance DC
R402003704		NC/NC	24 V	-10% / +10%

Part No.	Power consumption DC	Cable length	Electrical connection Pilot valve
R402003704	2,2 W	0,5 m	Plug 3-pin

Part No.	Protected against polarity reversal
R402003704	Protected against polarity reversal

Connection 12 must be connected with atmospheres, The valve must be supplied with compressed air via ports 3 and 5, Nominal flow  $Q_n$  at 6 bar and  $\Delta p = 1$  bar, MO = Manual override

## Technical information

The min. control pressure must be adhered to, since otherwise faulty switching and valve failure may result!

The pressure dew point must be at least 15 °C under ambient and medium temperature and may not exceed 3 °C .

The oil content of compressed air must remain constant during the life cycle.

Use only the approved oils from AVENTICS. Further information can be found in the "Technical information" document (available in the MediaCentre).

## Technical information

Housing	Polyamide fiber-glass reinforced
Seals	Acrylonitrile butadiene rubber

## Dimensions

## Dimensions

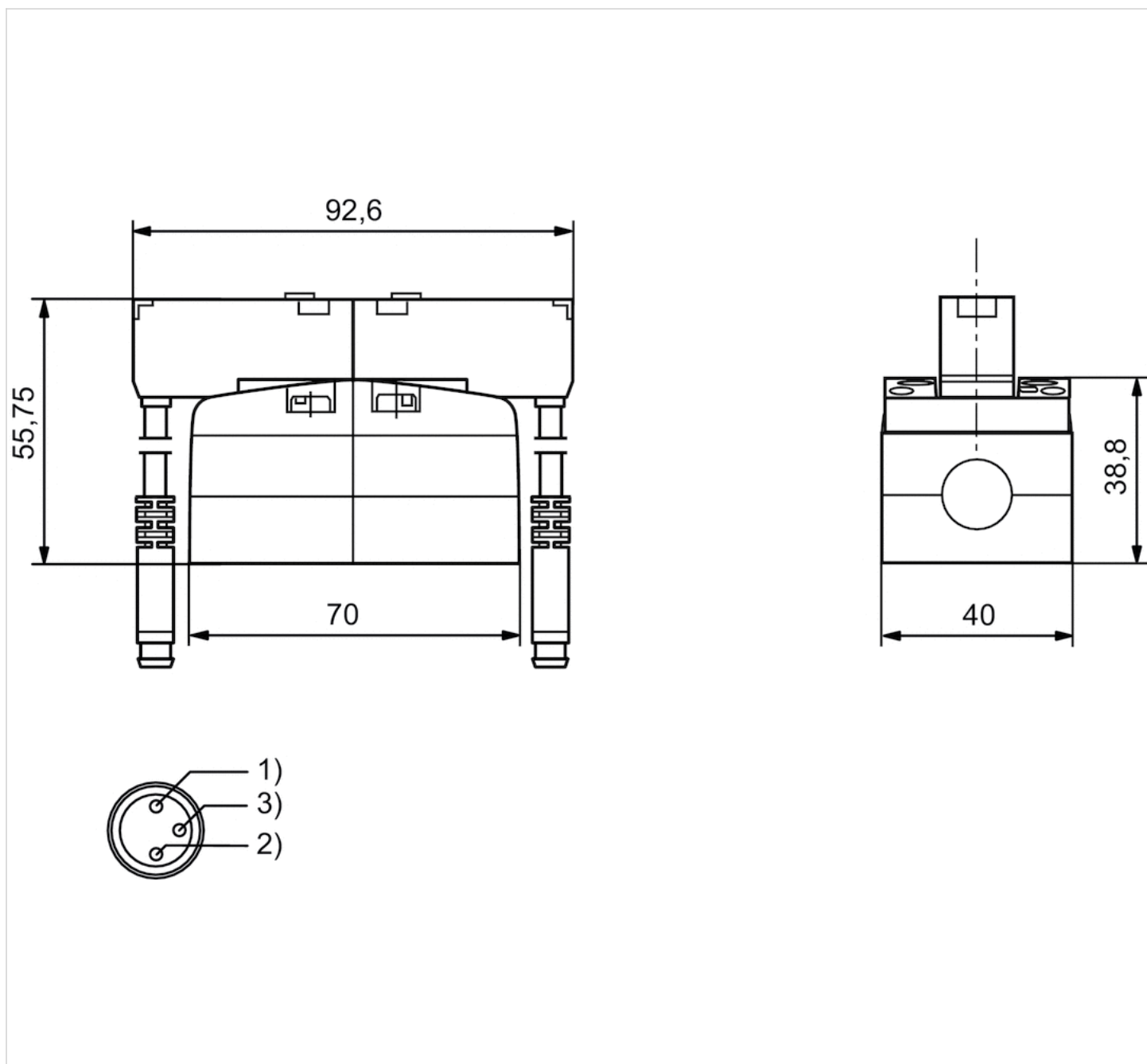

## Pin assignment

- 1) brown (+24 V)
- 2) green/yellow (ground)
- 3) blue (0 V)









# 5/2-directional valve, Series 581, size 1

- ISO 5599-1
- ISO 1
- 5/2
- With spring return
- single solenoid
- $Q_n = 1400$  l/min
- Compressed air connection output Base plate ISO 5599-1
- Electrical connection Plug, 3-pin
- Manual override without detent



Type	Spool valve
Sealing principle	Soft sealing
Blocking principle	Single base plate principle
Connection type	Plate connection
Standards	ISO 5599-1, ISO 1
Working pressure min./max.	See table below
Control pressure min./max.	3 ... 10 bar
Ambient temperature min./max.	-10 ... 50 °C
Medium temperature min./max.	-10 ... 50 °C
Medium	Compressed air
Max. particle size	50 µm
Oil content of compressed air	0 ... 5 mg/m <sup>3</sup>
Nominal flow $Q_n$	1400 l/min
Flow conductance C	5,2 l/(s*bar)
Protection class with connection	IP67
Protective circuit	Z-diode
Reverse polarity protection	Protected against polarity reversal
LED status display	Green
Duty cycle	100 %
Typ. switch-on time	15 ms
Typ. switch-off time	30 ms
Mounting screw	with hexagon socket
Mounting screw tightening torque	2 Nm
Weight	0,18 kg

## Technical data

Part No.		MO	Operational voltage DC	Voltage tolerance DC
5811150160			24 V	-10% / +10%
5811151160			24 V	-10% / +10%
5811152160			24 V	-10% / +10%
5811153160			24 V	-10% / +10%

Part No.	Power consumption DC	Pilot	Working pressure min./max.	Cable length
5811150160	2,2 W	Internal	3 ... 10 bar	0,5 m

Part No.	Power consumption DC	Pilot	Working pressure min./max.	Cable length
5811151160	2,2 W	Internal	3 ... 10 bar	0,5 m
5811152160	2,2 W	External	-0,95 ... 10 bar	0,5 m
5811153160	2,2 W	External	-0,95 ... 10 bar	0,5 m

Part No.	Electrical connection Pilot valve	Protected against polarity reversal	Throttle
5811150160	Plug 3-pin	Protected against polarity reversal	-
5811151160	Plug 3-pin	Protected against polarity reversal	with throttle
5811152160	Plug 3-pin	Protected against polarity reversal	-
5811153160	Plug 3-pin	Protected against polarity reversal	with throttle

Connection 12 must be connected with atmospheres, Nominal flow  $Q_n$  at 6 bar and  $\Delta p = 1$  bar, MO = Manual override

## Technical information

The min. control pressure must be adhered to, since otherwise faulty switching and valve failure may result!

The pressure dew point must be at least 15 °C under ambient and medium temperature and may not exceed 3 °C .

The oil content of compressed air must remain constant during the life cycle.

Use only the approved oils from AVENTICS. Further information can be found in the "Technical information" document (available in the MediaCentre).

## Technical information

Housing	Polyamide fiber-glass reinforced
Seals	Acrylonitrile butadiene rubber



## Dimensions

## Dimensions

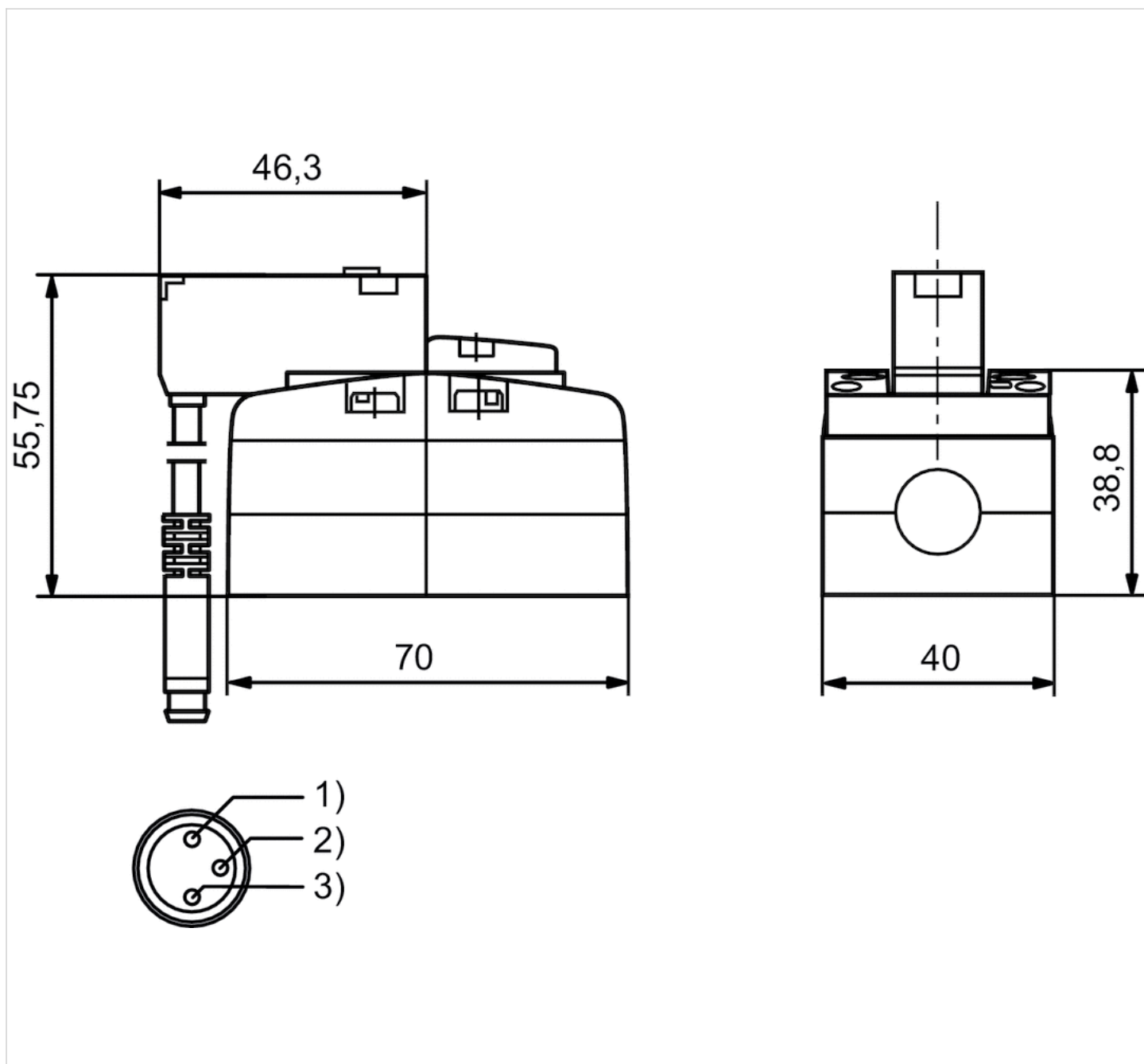

## Pin assignment

- 1) brown (+24 V)
- 2) green/yellow (ground)
- 3) blue (0 V)









# 5/2-directional valve, Series 581, size 1

- ISO 5599-1
- ISO 1
- 5/2
- double solenoid
- $Q_n = 1400$  l/min
- Compressed air connection output Base plate ISO 5599-1
- Electrical connection Plug, 3-pin
- Manual override without detent



Type	Spool valve
Sealing principle	Soft sealing
Blocking principle	Single base plate principle
Connection type	Plate connection
Standards	ISO 5599-1, ISO 1
Working pressure min./max.	See table below
Control pressure min./max.	1,5 ... 10 bar
Ambient temperature min./max.	-10 ... 50 °C
Medium temperature min./max.	-10 ... 50 °C
Medium	Compressed air
Max. particle size	50 µm
Oil content of compressed air	0 ... 5 mg/m <sup>3</sup>
Nominal flow $Q_n$	1400 l/min
Flow conductance C	5,2 l/(s*bar)
Protection class with connection	IP67
Protective circuit	Z-diode
Reverse polarity protection	Protected against polarity reversal
LED status display	Green
Duty cycle	100 %
Typ. switch-on time	14 ms
Typ. switch-off time	14 ms
Mounting screw	with hexagon socket
Mounting screw tightening torque	2 Nm
Weight	0,22 kg

## Technical data

Part No.		MO	Operational voltage DC	Voltage tolerance DC
5811260160			24 V	-10% / +10%
5811261160			24 V	-10% / +10%
5811262160			24 V	-10% / +10%
5811263160			24 V	-10% / +10%

Part No.	Power consumption DC	Pilot	Working pressure min./max.	Cable length
5811260160	2,2 W	Internal	1,5 ... 10 bar	0,5 m
5811261160	2,2 W	Internal	1,5 ... 10 bar	0,5 m

Part No.	Power consumption DC	Pilot	Working pressure min./max.	Cable length
5811262160	2,2 W	External	-0,95 ... 10 bar	0,5 m
5811263160	2,2 W	External	-0,95 ... 10 bar	0,5 m

Part No.	Electrical connection Pilot valve	Protected against polarity reversal	Throttle
5811260160	Plug 3-pin	Protected against polarity reversal	-
5811261160	Plug 3-pin	Protected against polarity reversal	with throttle
5811262160	Plug 3-pin	Protected against polarity reversal	-
5811263160	Plug 3-pin	Protected against polarity reversal	with throttle

Connection 12 must be connected with atmospheres, Nominal flow  $Q_n$  at 6 bar and  $\Delta p = 1$  bar, MO = Manual override

## Technical information

The min. control pressure must be adhered to, since otherwise faulty switching and valve failure may result!

The pressure dew point must be at least 15 °C under ambient and medium temperature and may not exceed 3 °C .

The oil content of compressed air must remain constant during the life cycle.

Use only the approved oils from AVENTICS. Further information can be found in the "Technical information" document (available in the MediaCentre).

## Technical information

Housing	Polyamide fiber-glass reinforced
Seals	Acrylonitrile butadiene rubber

## Dimensions

## Dimensions

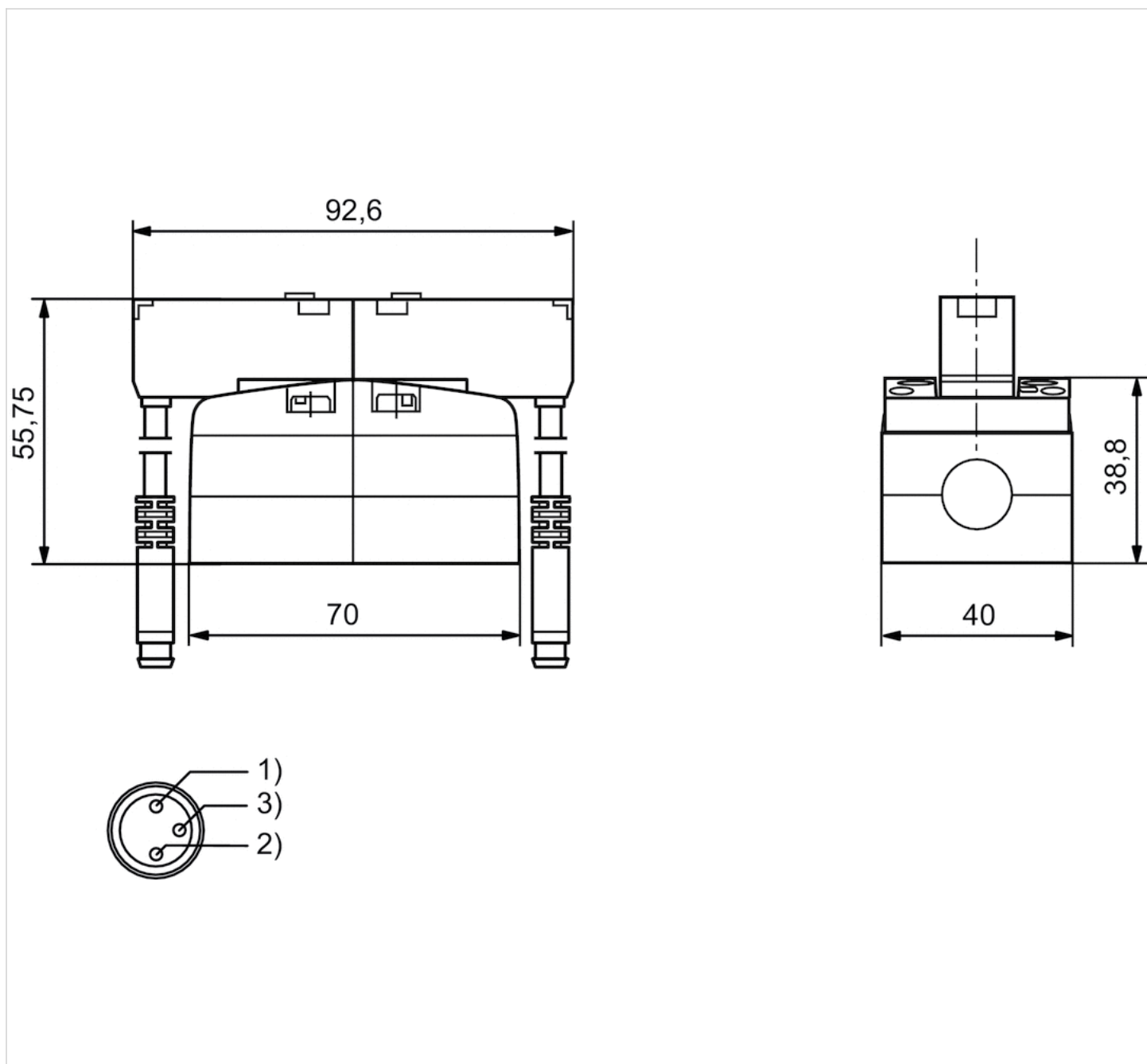

## Pin assignment

- 1) brown (+24 V)
- 2) green/yellow (ground)
- 3) blue (0 V)

























# 5/3-directional valve, Series 581, size 1

- ISO 5599-1
- ISO 1
- 5/3
- closed center exhausted center pressurized center
- Qn = 1100 l/min
- Compressed air connection output Base plate ISO 5599-1
- Electrical connection Plug, 3-pin
- Manual override without detent



Type	Spool valve
Sealing principle	Soft sealing
Blocking principle	Single base plate principle
Connection type	Plate connection
Standards	ISO 5599-1, ISO 1
Working pressure min./max.	See table below
Control pressure min./max.	3 ... 10 bar
Ambient temperature min./max.	-10 ... 50 °C
Medium temperature min./max.	-10 ... 50 °C
Medium	Compressed air
Max. particle size	50 µm
Oil content of compressed air	0 ... 5 mg/m <sup>3</sup>
Nominal flow Qn	1100 l/min
Flow conductance C	4,3 l/(s*bar)
Protection class with connection	IP67
Protective circuit	Z-diode
Reverse polarity protection	Protected against polarity reversal
LED status display	Green
Duty cycle	100 %
Typ. switch-on time	14 ms
Typ. switch-off time	22 ms
Mounting screw	with hexagon socket
Mounting screw tightening torque	2 Nm
Weight	0,22 kg

## Technical data

Part No.		MO		Operational voltage DC
5811460160			closed center	24 V
5811461160			closed center	24 V
5811462160			closed center	24 V
5811463160			closed center	24 V
5811560160			exhausted center	24 V
5811561160			exhausted center	24 V
5811562160			exhausted center	24 V
5811563160			exhausted center	24 V
5811760160			pressurized center	24 V
5811761160			pressurized center	24 V
5811762160			pressurized center	24 V
5811763160			pressurized center	24 V

Part No.	Voltage tolerance DC	Power consumption DC	Pilot	Working pressure min./max.
5811460160	-10% / +10%	2,2 W	Internal	3 ... 10 bar
5811461160	-10% / +10%	2,2 W	Internal	3 ... 10 bar
5811462160	-10% / +10%	2,2 W	External	-0,95 ... 10 bar
5811463160	-10% / +10%	2,2 W	External	-0,95 ... 10 bar
5811560160	-10% / +10%	2,2 W	Internal	3 ... 10 bar
5811561160	-10% / +10%	2,2 W	Internal	3 ... 10 bar
5811562160	-10% / +10%	2,2 W	External	-0,95 ... 10 bar
5811563160	-10% / +10%	2,2 W	External	-0,95 ... 10 bar
5811760160	-10% / +10%	2,2 W	Internal	3 ... 10 bar
5811761160	-10% / +10%	2,2 W	Internal	3 ... 10 bar
5811762160	-10% / +10%	2,2 W	External	-0,95 ... 10 bar
5811763160	-10% / +10%	2,2 W	External	-0,95 ... 10 bar

Part No.	Cable length	Electrical connection Pilot valve	Protected against polarity reversal
5811460160	0,5 m	Plug 3-pin	Protected against polarity reversal
5811461160	0,5 m	Plug 3-pin	Protected against polarity reversal
5811462160	0,5 m	Plug 3-pin	Protected against polarity reversal
5811463160	0,5 m	Plug 3-pin	Protected against polarity reversal
5811560160	0,5 m	Plug 3-pin	Protected against polarity reversal
5811561160	0,5 m	Plug 3-pin	Protected against polarity reversal
5811562160	0,5 m	Plug 3-pin	Protected against polarity reversal
5811563160	0,5 m	Plug 3-pin	Protected against polarity reversal
5811760160	0,5 m	Plug 3-pin	Protected against polarity reversal
5811761160	0,5 m	Plug 3-pin	Protected against polarity reversal
5811762160	0,5 m	Plug 3-pin	Protected against polarity reversal
5811763160	0,5 m	Plug 3-pin	Protected against polarity reversal

Part No.	Throttle
5811460160	-
5811461160	with throttle
5811462160	-
5811463160	with throttle
5811560160	-
5811561160	with throttle
5811562160	-
5811563160	with throttle
5811760160	-
5811761160	with throttle
5811762160	-
5811763160	with throttle

Connection 12 must be connected with atmospheres, Nominal flow Qn at 6 bar and  $\Delta p = 1$  bar, MO = Manual override

## Technical information

The min. control pressure must be adhered to, since otherwise faulty switching and valve failure may result!

The pressure dew point must be at least 15 °C under ambient and medium temperature and may not exceed 3 °C .

The oil content of compressed air must remain constant during the life cycle.

Use only the approved oils from AVENTICS. Further information can be found in the "Technical information" document (available in the MediaCentre).

## Technical information

Housing	Polyamide fiber-glass reinforced
Seals	Acrylonitrile butadiene rubber

## Dimensions

### Dimensions

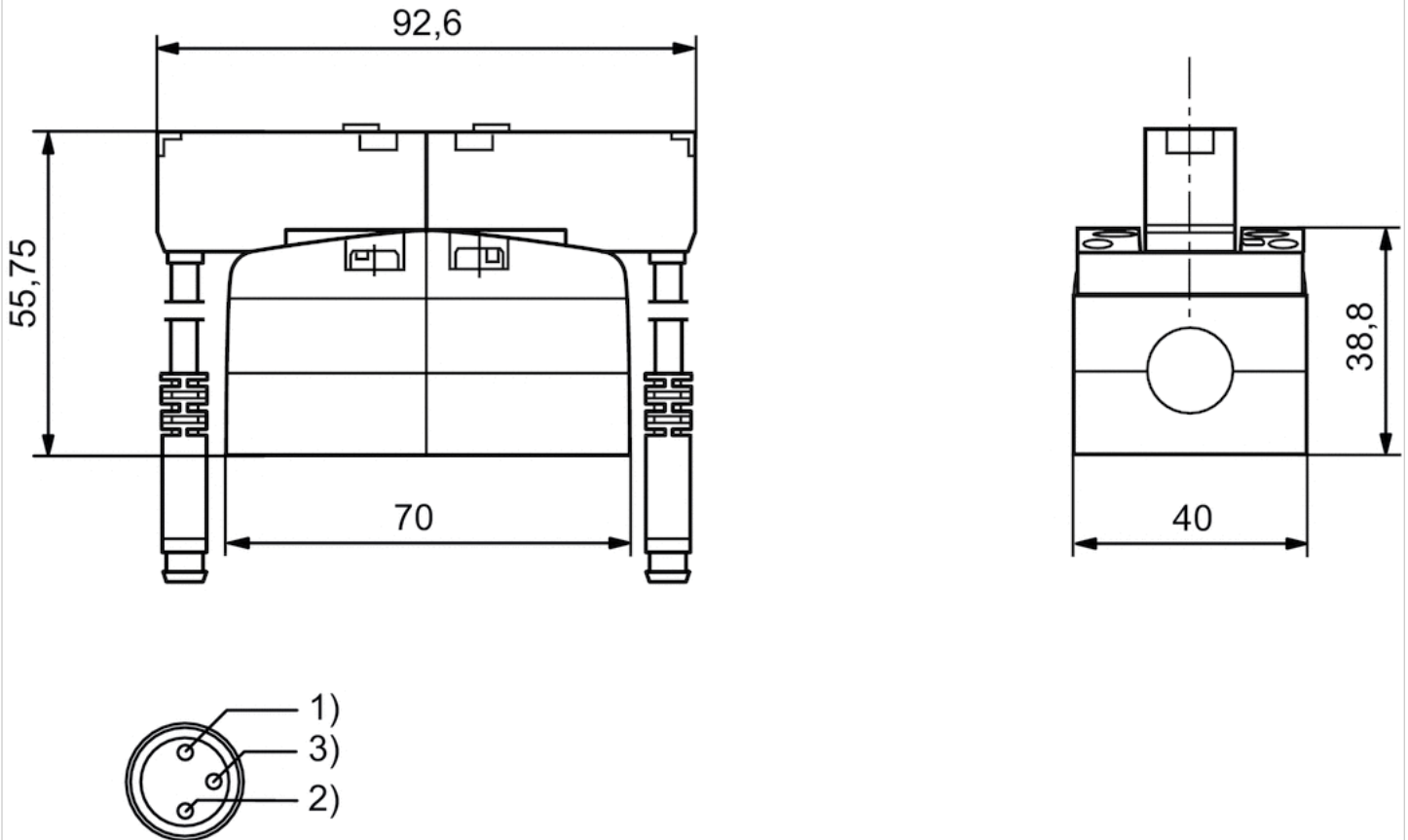

Pin assignment

- 1) brown (+24 V)
- 2) green/yellow (ground)
- 3) blue (0 V)







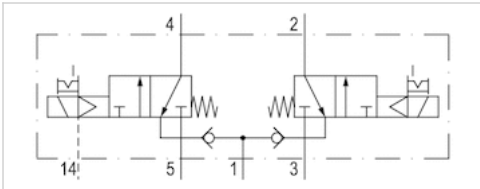

# 2x3/2-directional valve, Series 581, size 1

- ISO 5599-1
- ISO 1
- 2x3/2
- NC/NC
- Qn = 950 l/min
- Compressed air connection output Base plate ISO 5599-1
- Electrical connection Plug, Form B, industry
- Manual override with detent



Type	Spool valve
Pilot	External
Sealing principle	Soft sealing
Blocking principle	Single base plate principle
Connection type	Plate connection
Standards	ISO 5599-1, ISO 1
Working pressure min./max.	0 ... 8 bar
Control pressure min./max.	3,5 ... 8 bar
Ambient temperature min./max.	-15 ... 50 °C
Medium temperature min./max.	-15 ... 50 °C
Medium	Compressed air
Max. particle size	50 µm
Oil content of compressed air	0 ... 5 mg/m <sup>3</sup>
Nominal flow Qn	950 l/min
Flow conductance C	3,2 l/(s*bar)
Protection class with connection	IP65
Duty cycle	100 %
Typ. switch-on time	12 ms
Typ. switch-off time	22 ms
Mounting screw	with hexagon socket
Mounting screw tightening torque	2 Nm
Weight	0,3 kg

## Technical data

Part No.	MO		Operational voltage DC	Operational voltage AC 50 Hz
R402003714		NC/NC	12 V	-
R402003711		NC/NC	-	24 V
R402003710		NC/NC	24 V	-
R402003715		NC/NC	48 V	-
R402003712		NC/NC	-	-
R402003713		NC/NC	-	230 V
R402003709		NC/NC	-	-

Part No.	Operational voltage AC 60 Hz	Voltage tolerance DC	Voltage tolerance AC 50 Hz	Voltage tolerance AC 60 Hz
R402003714	-	-10% / +10%	-	-
R402003711	-	-	-10% / +10%	-
R402003710	-	-10% / +10%	-	-
R402003715	-	-10% / +10%	-	-
R402003712	110 V	-	-	-10% / +10%
R402003713	-	-	-10% / +10%	-
R402003709	-	-	-	-

Part No.	Power consumption DC	Holding power AC 50 Hz	Holding power AC 60 Hz	Switch-on power AC 50 Hz
R402003714	5 W	-	-	-
R402003711	-	8 VA	-	10 VA
R402003710	5 W	-	-	-
R402003715	5 W	-	-	-
R402003712	-	-	8 VA	-
R402003713	-	8 VA	-	10 VA
R402003709	-	-	-	-

Part No.	Switch-on power AC 60 Hz	Electrical connection Pilot valve	basic valve with electrical connector
R402003714	-	Plug Form B, industry	-
R402003711	-	Plug Form B, industry	-
R402003710	-	Plug Form B, industry	-
R402003715	-	Plug Form B, industry	-
R402003712	10 VA	Plug Form B, industry	-
R402003713	-	Plug Form B, industry	-
R402003709	-	Plug Form B, industry	Basic valve without coil

The valve must be supplied with compressed air via ports 3 and 5, Nominal flow Qn at 6 bar and  $\Delta p = 1$  bar, MO = Manual override

## Technical information

The min. control pressure must be adhered to, since otherwise faulty switching and valve failure may result!  
The pressure dew point must be at least 15 °C under ambient and medium temperature and may not exceed 3 °C .  
The oil content of compressed air must remain constant during the life cycle.  
Use only the approved oils from AVENTICS. Further information can be found in the “Technical information” document (available in the MediaCentre).

## Technical information

Housing	Polyamide fiber-glass reinforced
Seals	Acrylonitrile butadiene rubber

## Dimensions

### Dimensions

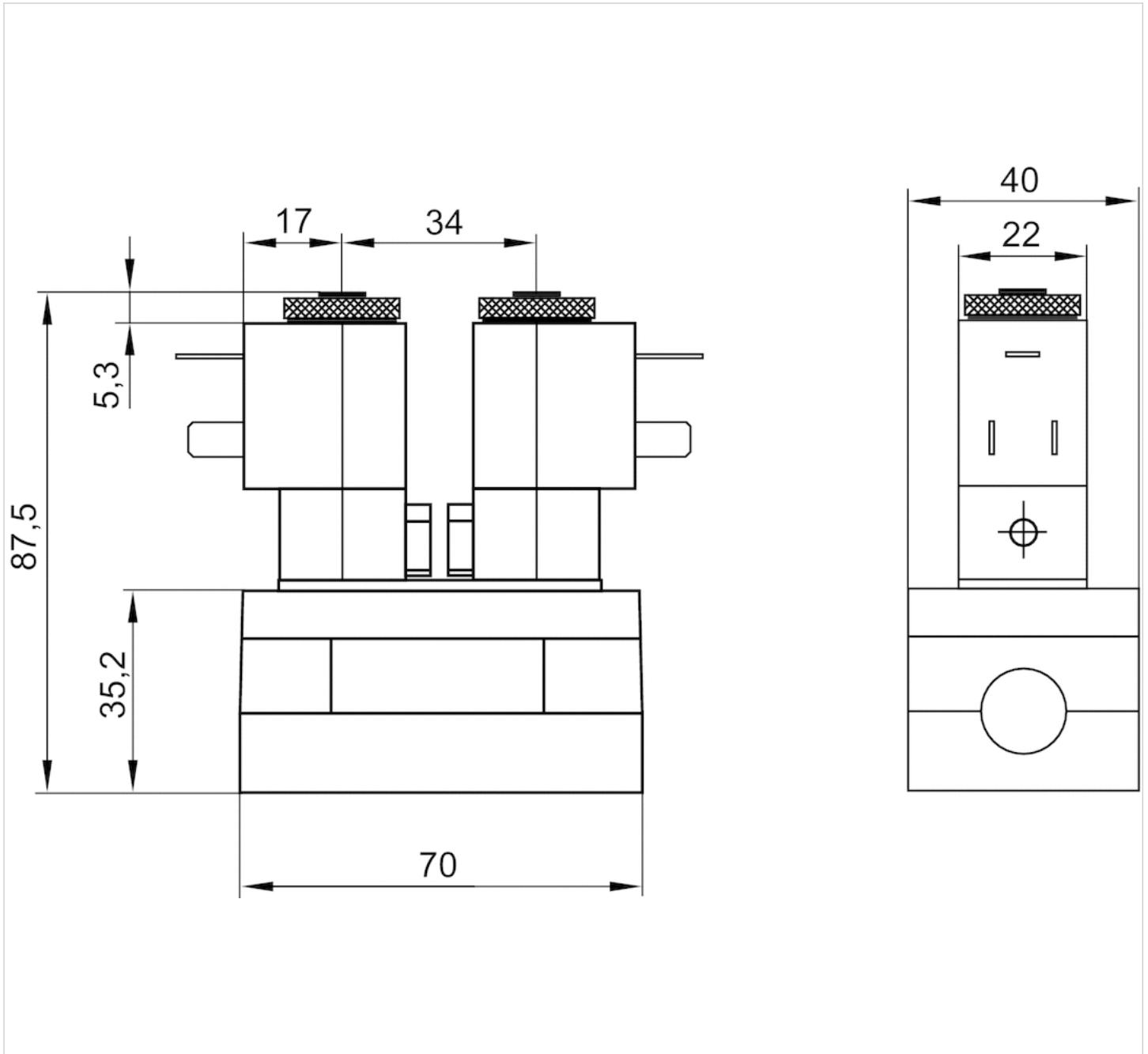

The pilot valves can be loosened and turned through 180°.

# 5/2-directional valve, Series 581, size 1

- ISO 5599-1
- ISO 1
- 5/2
- With spring return
- single solenoid
- $Q_n = 1400 \text{ l/min}$
- Compressed air connection output Base plate ISO 5599-1
- Electrical connection Plug, Form B, industry
- Manual override with detent



Type	Spool valve
Sealing principle	Soft sealing
Blocking principle	Single base plate principle
Connection type	Plate connection
Standards	ISO 5599-1, ISO 1
Working pressure min./max.	See table below
Control pressure min./max.	3 ... 10 bar
Ambient temperature min./max.	-15 ... 50 °C
Medium temperature min./max.	-15 ... 50 °C
Medium	Compressed air
Max. particle size	50 µm
Oil content of compressed air	0 ... 5 mg/m <sup>3</sup>
Nominal flow $Q_n$	1400 l/min
Flow conductance C	5,2 l/(s*bar)
Protection class with connection	IP65
Duty cycle	100 %
Typ. switch-on time	12 ms
Typ. switch-off time	28 ms
Mounting screw	with hexagon socket
Mounting screw tightening torque	2 Nm
Weight	0,23 kg

## Technical data

Part No.		MO	Operational voltage DC	Operational voltage AC 50 Hz
5811110500			12 V	-
5811110200			-	24 V
5811110100			24 V	-
5811110600			48 V	-
5811110300			-	-
5811110400			-	230 V
5811110000			-	-
5811111500			12 V	-
5811111200			-	24 V
5811111100			24 V	-
5811111600			48 V	-
5811111300			-	-
5811111400			-	230 V
5811111000			-	-
5811112500			12 V	-
5811112200			-	24 V
5811112100			24 V	-
5811112600			48 V	-
5811112300			-	-
5811112400			-	230 V
5811112000			-	-
5811113500			12 V	-
5811113200			-	24 V
5811113600			48 V	-
5811113100			24 V	-
5811113300			-	-
5811113400			-	230 V
5811113000			-	-

Part No.	Operational voltage AC 60 Hz	Voltage tolerance DC	Voltage tolerance AC 50 Hz	Voltage tolerance AC 60 Hz
5811110500	-	-10% / +10%	-	-
5811110200	-	-	-10% / +10%	-
5811110100	-	-10% / +10%	-	-
5811110600	-	-10% / +10%	-	-
5811110300	110 V	-	-	-10% / +10%
5811110400	-	-	-10% / +10%	-
5811110000	-	-	-	-
5811111500	-	-10% / +10%	-	-
5811111200	-	-	-10% / +10%	-
5811111100	-	-10% / +10%	-	-
5811111600	-	-10% / +10%	-	-
5811111300	110 V	-	-	-10% / +10%

Part No.	Operational voltage AC 60 Hz	Voltage tolerance DC	Voltage tolerance AC 50 Hz	Voltage tolerance AC 60 Hz
5811111400	-	-	-10% / +10%	-
5811111000	-	-	-	-
5811112500	-	-10% / +10%	-	-
5811112200	-	-	-10% / +10%	-
5811112100	-	-10% / +10%	-	-
5811112600	-	-10% / +10%	-	-
5811112300	110 V	-	-	-10% / +10%
5811112400	-	-	-10% / +10%	-
5811112000	-	-	-	-
5811113500	-	-10% / +10%	-	-
5811113200	-	-	-10% / +10%	-
5811113600	-	-10% / +10%	-	-
5811113100	-	-10% / +10%	-	-
5811113300	110 V	-	-	-10% / +10%
5811113400	-	-	-10% / +10%	-
5811113000	-	-	-	-

Part No.	Power consumption DC	Holding power AC 50 Hz	Holding power AC 60 Hz	Switch-on power AC 50 Hz
5811110500	5 W	-	-	-
5811110200	-	8 VA	-	10 VA
5811110100	5 W	-	-	-
5811110600	5 W	-	-	-
5811110300	-	-	8 VA	-
5811110400	-	8 VA	-	10 VA
5811110000	-	-	-	-
5811111500	5 W	-	-	-
5811111200	-	8 VA	-	10 VA
5811111100	5 W	-	-	-
5811111600	5 W	-	-	-
5811111300	-	-	8 VA	-
5811111400	-	8 VA	-	10 VA
5811111000	-	-	-	-
5811112500	5 W	-	-	-
5811112200	-	8 VA	-	10 VA
5811112100	5 W	-	-	-
5811112600	5 W	-	-	-
5811112300	-	-	8 VA	-
5811112400	-	8 VA	-	10 VA
5811112000	-	-	-	-
5811113500	5 W	-	-	-
5811113200	-	8 VA	-	10 VA
5811113600	5 W	-	-	-
5811113100	5 W	-	-	-
5811113300	-	-	8 VA	-
5811113400	-	8 VA	-	10 VA
5811113000	-	-	-	-

Part No.	Switch-on power AC 60 Hz	Pilot	Working pressure min./max.	Electrical connection Pilot valve
5811110500	-	Internal	3 ... 10 bar	Plug Form B, industry
5811110200	-	Internal	3 ... 10 bar	Plug Form B, industry
5811110100	-	Internal	3 ... 10 bar	Plug Form B, industry
5811110600	-	Internal	3 ... 10 bar	Plug Form B, industry
5811110300	10 VA	Internal	3 ... 10 bar	Plug Form B, industry
5811110400	-	Internal	3 ... 10 bar	Plug Form B, industry
5811110000	-	Internal	3 ... 10 bar	Plug Form B, industry
5811111500	-	Internal	3 ... 10 bar	Plug Form B, industry
5811111200	-	Internal	3 ... 10 bar	Plug Form B, industry
5811111100	-	Internal	3 ... 10 bar	Plug Form B, industry
5811111600	-	Internal	3 ... 10 bar	Plug Form B, industry
5811111300	10 VA	Internal	3 ... 10 bar	Plug Form B, industry
5811111400	-	Internal	3 ... 10 bar	Plug Form B, industry
5811111000	-	Internal	3 ... 10 bar	Plug Form B, industry
5811112500	-	External	-0,95 ... 10 bar	Plug Form B, industry
5811112200	-	External	-0,95 ... 10 bar	Plug Form B, industry
5811112100	-	External	-0,95 ... 10 bar	Plug Form B, industry
5811112600	-	External	-0,95 ... 10 bar	Plug Form B, industry
5811112300	10 VA	External	-0,95 ... 10 bar	Plug Form B, industry
5811112400	-	External	-0,95 ... 10 bar	Plug Form B, industry
5811112000	-	External	-0,95 ... 10 bar	Plug Form B, industry
5811113500	-	External	-0,95 ... 10 bar	Plug Form B, industry
5811113200	-	External	-0,95 ... 10 bar	Plug Form B, industry
5811113600	-	External	-0,95 ... 10 bar	Plug Form B, industry
5811113100	-	External	-0,95 ... 10 bar	Plug Form B, industry
5811113300	10 VA	External	-0,95 ... 10 bar	Plug Form B, industry
5811113400	-	External	-0,95 ... 10 bar	Plug Form B, industry
5811113000	-	External	-0,95 ... 10 bar	Plug Form B, industry

Part No.	basic valve with electrical connector	Throttle
5811110500	-	-
5811110200	-	-
5811110100	-	-
5811110600	-	-
5811110300	-	-
5811110400	-	-
5811110000	Basic valve without coil	-
5811111500	-	with throttle
5811111200	-	with throttle
5811111100	-	with throttle
5811111600	-	with throttle
5811111300	-	with throttle
5811111400	-	with throttle
5811111000	Basic valve without coil	with throttle
5811112500	-	-
5811112200	-	-



Part No.	basic valve with electrical connector	Throttle
5811112100	-	-
5811112600	-	-
5811112300	-	-
5811112400	-	-
5811112000	Basic valve without coil	-
5811113500	-	with throttle
5811113200	-	with throttle
5811113600	-	with throttle
5811113100	-	with throttle
5811113300	-	with throttle
5811113400	-	with throttle
5811113000	Basic valve without coil	with throttle

Connection 12 must be connected with atmospheres, Nominal flow Qn at 6 bar and  $\Delta p = 1$  bar, MO = Manual override

## Technical information

The min. control pressure must be adhered to, since otherwise faulty switching and valve failure may result!

The pressure dew point must be at least 15 °C under ambient and medium temperature and may not exceed 3 °C .

The oil content of compressed air must remain constant during the life cycle.

Use only the approved oils from AVENTICS. Further information can be found in the "Technical information" document (available in the MediaCentre).

## Technical information

Housing	Polyamide fiber-glass reinforced
Seals	Acrylonitrile butadiene rubber

## Dimensions

### Dimensions

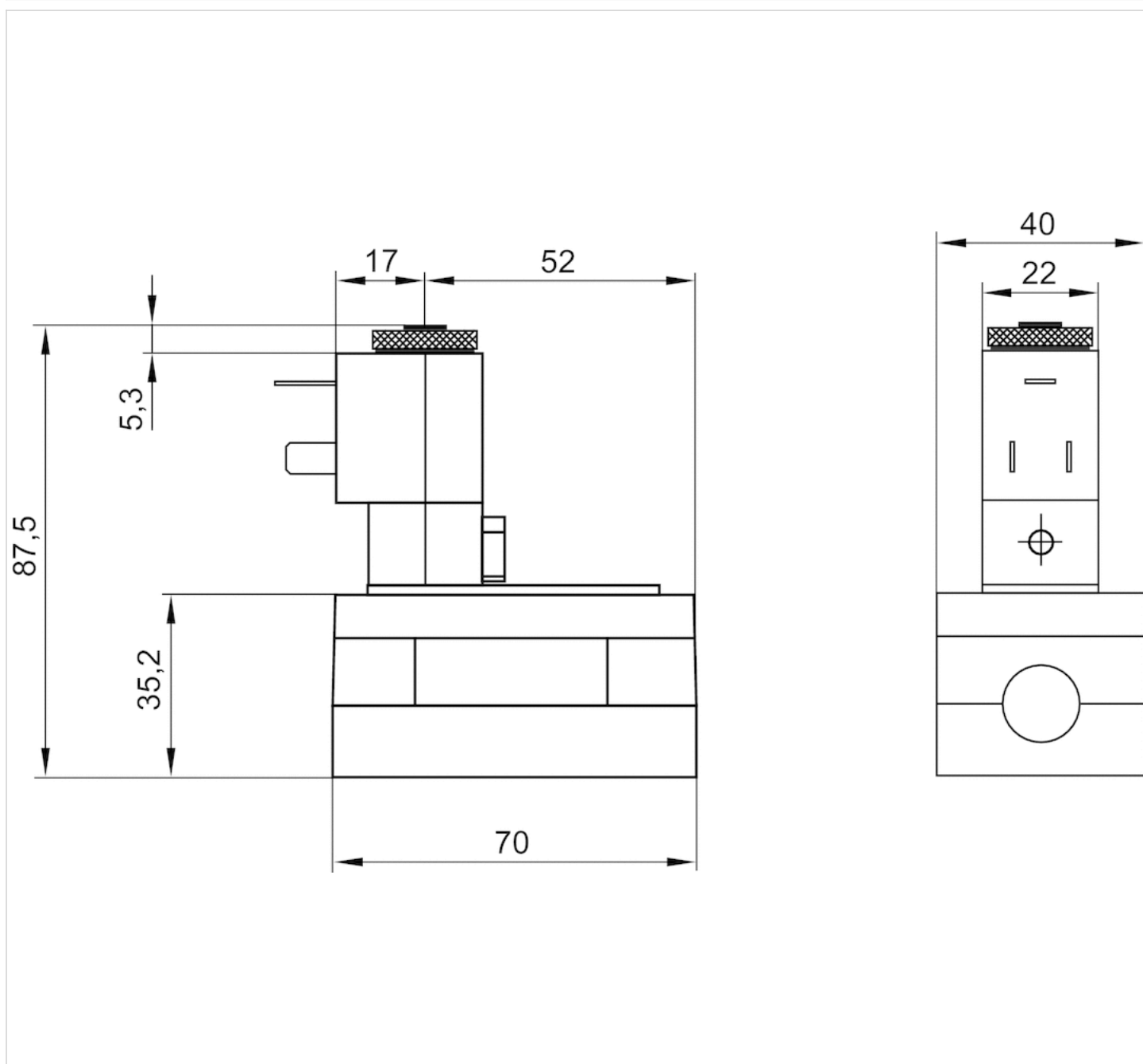

The pilot valves can be loosened and turned through 180°.

























































# 5/2-directional valve, Series 581, size 1

- ISO 5599-1
- ISO 1
- 5/2
- double solenoid
- $Q_n = 1400$  l/min
- Compressed air connection output Base plate ISO 5599-1
- Electrical connection Plug, Form B, industry
- Manual override with detent



Type	Spool valve
Sealing principle	Soft sealing
Blocking principle	Single base plate principle
Connection type	Plate connection
Standards	ISO 5599-1, ISO 1
Working pressure min./max.	See table below
Control pressure min./max.	1,5 ... 10 bar
Ambient temperature min./max.	-15 ... 50 °C
Medium temperature min./max.	-15 ... 50 °C
Medium	Compressed air
Max. particle size	50 µm
Oil content of compressed air	0 ... 5 mg/m <sup>3</sup>
Nominal flow $Q_n$	1400 l/min
Flow conductance C	5,2 l/(s*bar)
Protection class with connection	IP65
Duty cycle	100 %
Typ. switch-on time	11 ms
Typ. switch-off time	11 ms
Mounting screw	with hexagon socket
Mounting screw tightening torque	2 Nm
Weight	0,3 kg

## Technical data

Part No.		MO	Operational voltage DC	Operational voltage AC 50 Hz
5811220500			12 V	-
5811220200			-	24 V
5811220100			24 V	-
5811220600			48 V	-
5811220300			-	-
5811220400			-	230 V
5811220000			-	-
5811221500			12 V	-
5811221200			-	24 V
5811221100			24 V	-
5811221600			48 V	-
5811221300			-	-
5811221400			-	230 V
5811221000			-	-
5811222500			12 V	-
5811222200			-	24 V
5811222100			24 V	-
5811222600			48 V	-
5811222300			-	-
5811222400			-	230 V
5811222000			-	-
5811223500			12 V	-
5811223200			-	24 V
5811223100			24 V	-
5811223600			48 V	-
5811223300			-	-
5811223400			-	230 V
5811223000			-	-

Part No.	Operational voltage AC 60 Hz	Voltage tolerance DC	Voltage tolerance AC 50 Hz	Voltage tolerance AC 60 Hz
5811220500	-	-10% / +10%	-	-
5811220200	-	-	-10% / +10%	-
5811220100	-	-10% / +10%	-	-
5811220600	-	-10% / +10%	-	-
5811220300	110 V	-	-	-10% / +10%
5811220400	-	-	-10% / +10%	-
5811220000	-	-	-	-
5811221500	-	-10% / +10%	-	-
5811221200	-	-	-10% / +10%	-
5811221100	-	-10% / +10%	-	-
5811221600	-	-10% / +10%	-	-
5811221300	110 V	-	-	-10% / +10%

Part No.	Operational voltage AC 60 Hz	Voltage tolerance DC	Voltage tolerance AC 50 Hz	Voltage tolerance AC 60 Hz
5811221400	-	-	-10% / +10%	-
5811221000	-	-	-	-
5811222500	-	-10% / +10%	-	-
5811222200	-	-	-10% / +10%	-
5811222100	-	-10% / +10%	-	-
5811222600	-	-10% / +10%	-	-
5811222300	110 V	-	-	-10% / +10%
5811222400	-	-	-10% / +10%	-
5811222000	-	-	-	-
5811223500	-	-10% / +10%	-	-
5811223200	-	-	-10% / +10%	-
5811223100	-	-10% / +10%	-	-
5811223600	-	-10% / +10%	-	-
5811223300	110 V	-	-	-10% / +10%
5811223400	-	-	-10% / +10%	-
5811223000	-	-	-	-

Part No.	Power consumption DC	Holding power AC 50 Hz	Holding power AC 60 Hz	Switch-on power AC 50 Hz
5811220500	5 W	-	-	-
5811220200	-	8 VA	-	10 VA
5811220100	5 W	-	-	-
5811220600	5 W	-	-	-
5811220300	-	-	8 VA	-
5811220400	-	8 VA	-	10 VA
5811220000	-	-	-	-
5811221500	5 W	-	-	-
5811221200	-	8 VA	-	10 VA
5811221100	5 W	-	-	-
5811221600	5 W	-	-	-
5811221300	-	-	8 VA	-
5811221400	-	8 VA	-	10 VA
5811221000	-	-	-	-
5811222500	5 W	-	-	-
5811222200	-	8 VA	-	10 VA
5811222100	5 W	-	-	-
5811222600	5 W	-	-	-
5811222300	-	-	8 VA	-
5811222400	-	8 VA	-	10 VA
5811222000	-	-	-	-
5811223500	5 W	-	-	-
5811223200	-	8 VA	-	10 VA
5811223100	5 W	-	-	-
5811223600	5 W	-	-	-
5811223300	-	-	8 VA	-
5811223400	-	8 VA	-	10 VA
5811223000	-	-	-	-

Part No.	Switch-on power AC 60 Hz	Pilot	Working pressure min./max.	Electrical connection Pilot valve
5811220500	-	Internal	1,5 ... 10 bar	Plug Form B, industry
5811220200	-	Internal	1,5 ... 10 bar	Plug Form B, industry
5811220100	-	Internal	1,5 ... 10 bar	Plug Form B, industry
5811220600	-	Internal	1,5 ... 10 bar	Plug Form B, industry
5811220300	10 VA	Internal	1,5 ... 10 bar	Plug Form B, industry
5811220400	-	Internal	1,5 ... 10 bar	Plug Form B, industry
5811220000	-	Internal	1,5 ... 10 bar	Plug Form B, industry
5811221500	-	Internal	1,5 ... 10 bar	Plug Form B, industry
5811221200	-	Internal	1,5 ... 10 bar	Plug Form B, industry
5811221100	-	Internal	1,5 ... 10 bar	Plug Form B, industry
5811221600	-	Internal	1,5 ... 10 bar	Plug Form B, industry
5811221300	10 VA	Internal	1,5 ... 10 bar	Plug Form B, industry
5811221400	-	Internal	1,5 ... 10 bar	Plug Form B, industry
5811221000	-	Internal	1,5 ... 10 bar	Plug Form B, industry
5811222500	-	External	-0,95 ... 10 bar	Plug Form B, industry
5811222200	-	External	-0,95 ... 10 bar	Plug Form B, industry
5811222100	-	External	-0,95 ... 10 bar	Plug Form B, industry
5811222600	-	External	-0,95 ... 10 bar	Plug Form B, industry
5811222300	10 VA	External	-0,95 ... 10 bar	Plug Form B, industry
5811222400	-	External	-0,95 ... 10 bar	Plug Form B, industry
5811222000	-	External	-0,95 ... 10 bar	Plug Form B, industry
5811223500	-	External	-0,95 ... 10 bar	Plug Form B, industry
5811223200	-	External	-0,95 ... 10 bar	Plug Form B, industry
5811223100	-	External	-0,95 ... 10 bar	Plug Form B, industry
5811223600	-	External	-0,95 ... 10 bar	Plug Form B, industry
5811223300	10 VA	External	-0,95 ... 10 bar	Plug Form B, industry
5811223400	-	External	-0,95 ... 10 bar	Plug Form B, industry
5811223000	-	External	-0,95 ... 10 bar	Plug Form B, industry

Part No.	basic valve with electrical connector	Throttle
5811220500	-	-
5811220200	-	-
5811220100	-	-
5811220600	-	-
5811220300	-	-
5811220400	-	-
5811220000	Basic valve without coil	-
5811221500	-	with throttle
5811221200	-	with throttle
5811221100	-	with throttle
5811221600	-	with throttle
5811221300	-	with throttle
5811221400	-	with throttle
5811221000	Basic valve without coil	with throttle
5811222500	-	-
5811222200	-	-

Part No.	basic valve with electrical connector	Throttle
5811222100	-	-
5811222600	-	-
5811222300	-	-
5811222400	-	-
5811222000	Basic valve without coil	-
5811223500	-	with throttle
5811223200	-	with throttle
5811223100	-	with throttle
5811223600	-	with throttle
5811223300	-	with throttle
5811223400	-	with throttle
5811223000	Basic valve without coil	with throttle

Nominal flow Qn at 6 bar and Δp = 1 bar, MO = Manual override

## Technical information

The min. control pressure must be adhered to, since otherwise faulty switching and valve failure may result!  
 The pressure dew point must be at least 15 °C under ambient and medium temperature and may not exceed 3 °C .  
 The oil content of compressed air must remain constant during the life cycle.  
 Use only the approved oils from AVENTICS. Further information can be found in the “Technical information” document (available in the MediaCentre).

## Technical information

Housing	Polyamide fiber-glass reinforced
Seals	Acrylonitrile butadiene rubber

## Dimensions

### Dimensions

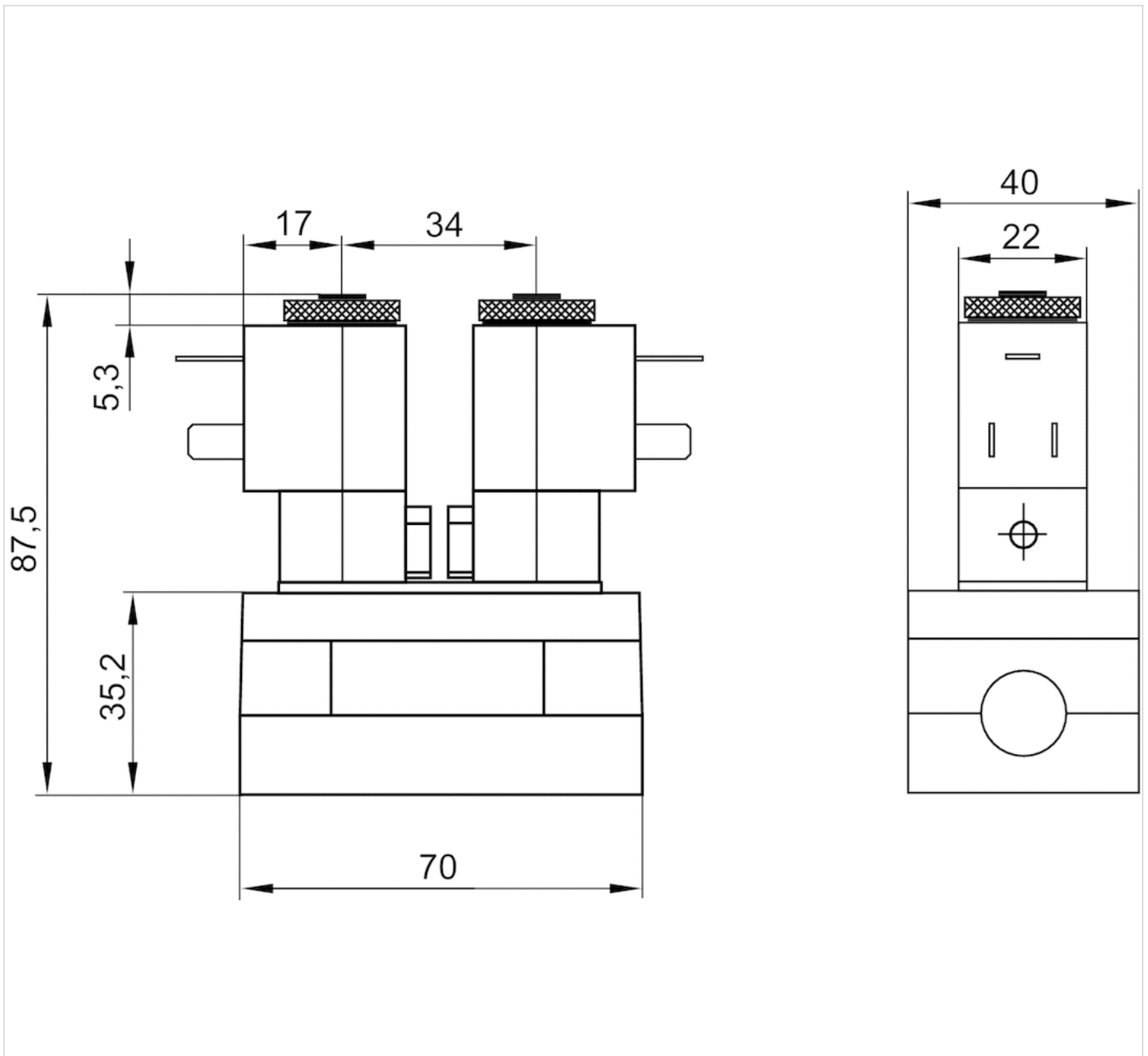

The pilot valves can be loosened and turned through 180°.



# 5/2-directional valve, Series 581, size 1

- ISO 5599-1
- ISO 1
- 5/2
- With differential piston
- With air spring return
- $Q_n = 1400 \text{ l/min}$
- Compressed air connection output Base plate ISO 5599-1
- Electrical connection Plug, Form B, industry
- Manual override with detent



Type	Spool valve
Sealing principle	Soft sealing
Blocking principle	Single base plate principle
Connection type	Plate connection
Standards	ISO 5599-1, ISO 1
Working pressure min./max.	See table below
Control pressure min./max.	1,3 ... 10 bar
Ambient temperature min./max.	-15 ... 50 °C
Medium temperature min./max.	-15 ... 50 °C
Medium	Compressed air
Max. particle size	50 µm
Oil content of compressed air	0 ... 5 mg/m <sup>3</sup>
Nominal flow $Q_n$	1400 l/min
Flow conductance C	5,2 l/(s*bar)
Protection class with connection	IP65
Duty cycle	100 %
Typ. switch-on time	12 ms
Typ. switch-off time	30 ms
Mounting screw	with hexagon socket
Mounting screw tightening torque	2 Nm
Weight	0,26 kg

## Technical data

Part No.		MO	Operational voltage DC	Operational voltage AC 50 Hz
5811610500			12 V	-
5811610200			-	24 V
5811610100			24 V	-
5811610600			48 V	-
5811610300			-	-
5811610400			-	230 V
5811610000			-	-
5811611500			12 V	-
5811611200			-	24 V
5811611100			24 V	-
5811611600			48 V	-
5811611300			-	-
5811611400			-	230 V
5811611000			-	-
5811612500			12 V	-
5811612200			-	24 V
5811612100			24 V	-
5811612600			48 V	-
5811612300			-	-
5811612400			-	230 V
5811612000			-	-
5811613500			12 V	-
5811613200			-	24 V
5811613100			24 V	-
5811613600			48 V	-
5811613300			-	-
5811613400			-	230 V
5811613000			-	-

Part No.	Operational voltage AC 60 Hz	Voltage tolerance DC	Voltage tolerance AC 50 Hz	Voltage tolerance AC 60 Hz
5811610500	-	-10% / +10%	-	-
5811610200	-	-	-10% / +10%	-
5811610100	-	-10% / +10%	-	-
5811610600	-	-10% / +10%	-	-
5811610300	110 V	-	-	-10% / +10%
5811610400	-	-	-10% / +10%	-
5811610000	-	-	-	-
5811611500	-	-10% / +10%	-	-
5811611200	-	-	-10% / +10%	-
5811611100	-	-10% / +10%	-	-
5811611600	-	-10% / +10%	-	-
5811611300	110 V	-	-	-10% / +10%

Part No.	Operational voltage AC 60 Hz	Voltage tolerance DC	Voltage tolerance AC 50 Hz	Voltage tolerance AC 60 Hz
5811611400	-	-	-10% / +10%	-
5811611000	-	-	-	-
5811612500	-	-10% / +10%	-	-
5811612200	-	-	-10% / +10%	-
5811612100	-	-10% / +10%	-	-
5811612600	-	-10% / +10%	-	-
5811612300	110 V	-	-	-10% / +10%
5811612400	-	-	-10% / +10%	-
5811612000	-	-	-	-
5811613500	-	-10% / +10%	-	-
5811613200	-	-	-10% / +10%	-
5811613100	-	-10% / +10%	-	-
5811613600	-	-10% / +10%	-	-
5811613300	110 V	-	-	-10% / +10%
5811613400	-	-	-10% / +10%	-
5811613000	-	-	-	-

Part No.	Power consumption DC	Holding power AC 50 Hz	Holding power AC 60 Hz	Switch-on power AC 50 Hz
5811610500	5 W	-	-	-
5811610200	-	8 VA	-	10 VA
5811610100	5 W	-	-	-
5811610600	5 W	-	-	-
5811610300	-	-	8 VA	-
5811610400	-	8 VA	-	10 VA
5811610000	-	-	-	-
5811611500	5 W	-	-	-
5811611200	-	8 VA	-	10 VA
5811611100	5 W	-	-	-
5811611600	5 W	-	-	-
5811611300	-	-	8 VA	-
5811611400	-	8 VA	-	10 VA
5811611000	-	-	-	-
5811612500	5 W	-	-	-
5811612200	-	8 VA	-	10 VA
5811612100	5 W	-	-	-
5811612600	5 W	-	-	-
5811612300	-	-	8 VA	-
5811612400	-	8 VA	-	10 VA
5811612000	-	-	-	-
5811613500	5 W	-	-	-
5811613200	-	8 VA	-	10 VA
5811613100	5 W	-	-	-
5811613600	5 W	-	-	-
5811613300	-	-	8 VA	-
5811613400	-	8 VA	-	10 VA
5811613000	-	-	-	-

Part No.	Switch-on power AC 60 Hz	Pilot	Working pressure min./max.	Electrical connection Pilot valve
5811610500	-	Internal	1,3 ... 10 bar	Plug Form B, industry
5811610200	-	Internal	1,3 ... 10 bar	Plug Form B, industry
5811610100	-	Internal	1,3 ... 10 bar	Plug Form B, industry
5811610600	-	Internal	1,3 ... 10 bar	Plug Form B, industry
5811610300	10 VA	Internal	1,3 ... 10 bar	Plug Form B, industry
5811610400	-	Internal	1,3 ... 10 bar	Plug Form B, industry
5811610000	-	Internal	1,3 ... 10 bar	Plug Form B, industry
5811611500	-	Internal	1,3 ... 10 bar	Plug Form B, industry
5811611200	-	Internal	1,3 ... 10 bar	Plug Form B, industry
5811611100	-	Internal	1,3 ... 10 bar	Plug Form B, industry
5811611600	-	Internal	1,3 ... 10 bar	Plug Form B, industry
5811611300	10 VA	Internal	1,3 ... 10 bar	Plug Form B, industry
5811611400	-	Internal	1,3 ... 10 bar	Plug Form B, industry
5811611000	-	Internal	1,3 ... 10 bar	Plug Form B, industry
5811612500	-	External	-0,95 ... 10 bar	Plug Form B, industry
5811612200	-	External	-0,95 ... 10 bar	Plug Form B, industry
5811612100	-	External	-0,95 ... 10 bar	Plug Form B, industry
5811612600	-	External	-0,95 ... 10 bar	Plug Form B, industry
5811612300	10 VA	External	-0,95 ... 10 bar	Plug Form B, industry
5811612400	-	External	-0,95 ... 10 bar	Plug Form B, industry
5811612000	-	External	-0,95 ... 10 bar	Plug Form B, industry
5811613500	-	External	-0,95 ... 10 bar	Plug Form B, industry
5811613200	-	External	-0,95 ... 10 bar	Plug Form B, industry
5811613100	-	External	-0,95 ... 10 bar	Plug Form B, industry
5811613600	-	External	-0,95 ... 10 bar	Plug Form B, industry
5811613300	10 VA	External	-0,95 ... 10 bar	Plug Form B, industry
5811613400	-	External	-0,95 ... 10 bar	Plug Form B, industry
5811613000	-	External	-0,95 ... 10 bar	Plug Form B, industry

Part No.	basic valve with electrical connector	Throttle
5811610500	-	-
5811610200	-	-
5811610100	-	-
5811610600	-	-
5811610300	-	-
5811610400	-	-
5811610000	Basic valve without coil	-
5811611500	-	with throttle
5811611200	-	with throttle
5811611100	-	with throttle
5811611600	-	with throttle
5811611300	-	with throttle
5811611400	-	with throttle
5811611000	Basic valve without coil	with throttle
5811612500	-	-
5811612200	-	-

Part No.	basic valve with electrical connector	Throttle
5811612100	-	-
5811612600	-	-
5811612300	-	-
5811612400	-	-
5811612000	Basic valve without coil	-
5811613500	-	with throttle
5811613200	-	with throttle
5811613100	-	with throttle
5811613600	-	with throttle
5811613300	-	with throttle
5811613400	-	with throttle
5811613000	Basic valve without coil	with throttle

Differential piston, signal 14 has priority, Nominal flow Qn at 6 bar and  $\Delta p = 1$  bar, MO = Manual override

## Technical information

The min. control pressure must be adhered to, since otherwise faulty switching and valve failure may result!  
 The pressure dew point must be at least 15 °C under ambient and medium temperature and may not exceed 3 °C .  
 The oil content of compressed air must remain constant during the life cycle.  
 Use only the approved oils from AVENTICS. Further information can be found in the "Technical information" document (available in the MediaCentre).

## Technical information

Housing	Polyamide fiber-glass reinforced
Seals	Acrylonitrile butadiene rubber

## Dimensions

### Dimensions

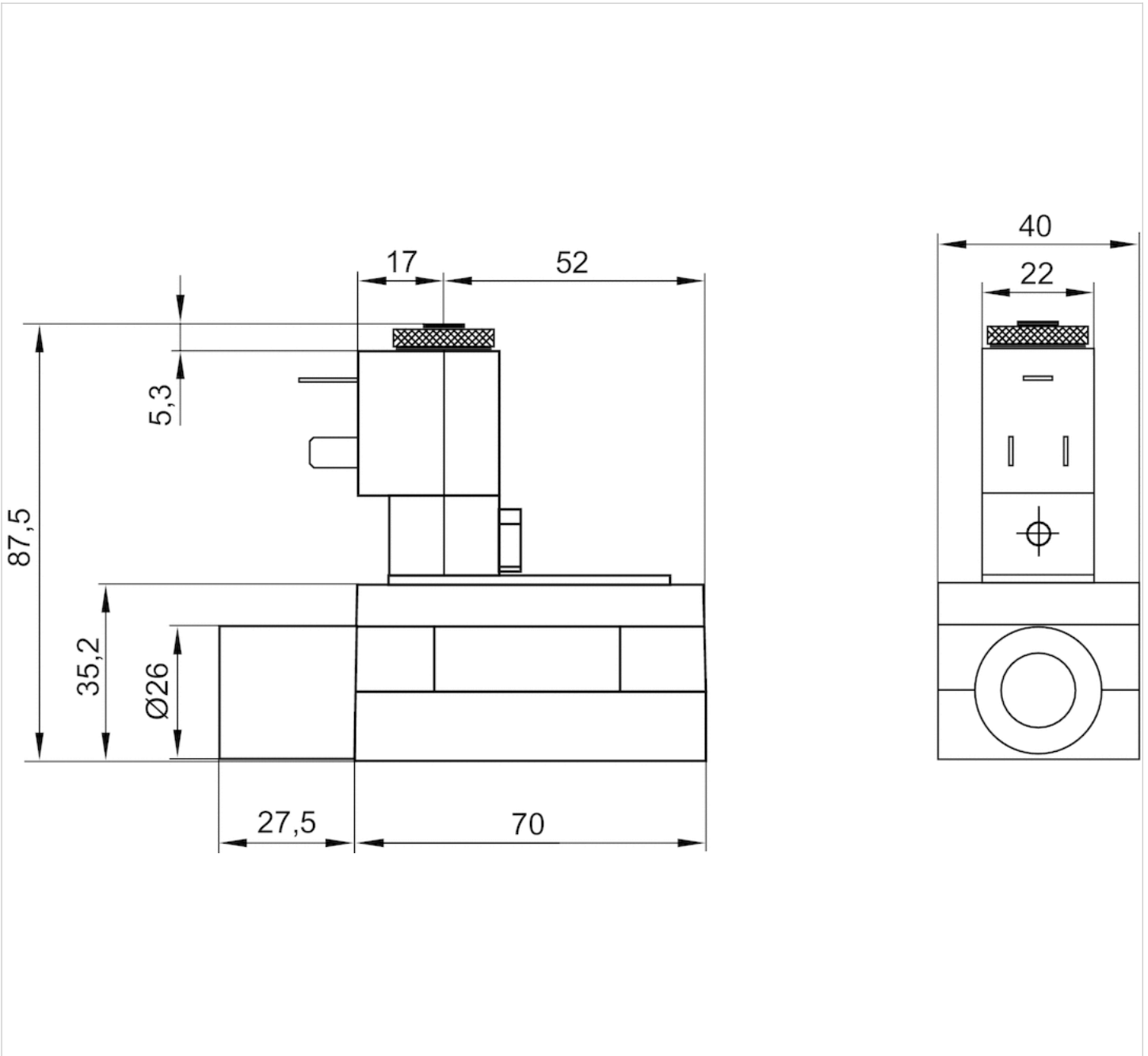

The pilot valves can be loosened and turned through 180°.











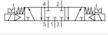

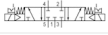

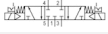



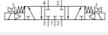



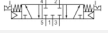

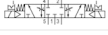

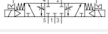

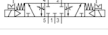

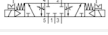

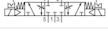

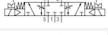

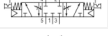

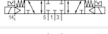



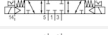

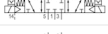

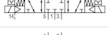

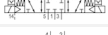

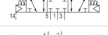

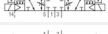

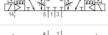

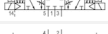
# 5/3-directional valve, Series 581, size 1

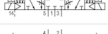
- ISO 5599-1
- ISO 1
- 5/3
- closed center
- $Q_n = 1100$  l/min
- Compressed air connection output Base plate ISO 5599-1
- Electrical connection Plug, Form B, industry
- Manual override with detent



Type	Spool valve
Sealing principle	Soft sealing
Blocking principle	Single base plate principle
Connection type	Plate connection
Standards	ISO 5599-1, ISO 1
Working pressure min./max.	See table below
Control pressure min./max.	3 ... 10 bar
Ambient temperature min./max.	-15 ... 50 °C
Medium temperature min./max.	-15 ... 50 °C
Medium	Compressed air
Max. particle size	50 µm
Oil content of compressed air	0 ... 5 mg/m <sup>3</sup>
Nominal flow $Q_n$	1100 l/min
Flow conductance C	4,3 l/(s*bar)
Protection class with connection	IP65
Duty cycle	100 %
Typ. switch-on time	15 ms
Typ. switch-off time	29 ms
Mounting screw	with hexagon socket
Mounting screw tightening torque	2 Nm
Weight	0,3 kg

## Technical data

Part No.		MO		Operational voltage DC
5811420500			closed center	12 V
5811420200			closed center	-
5811420100			closed center	24 V
5811420600			closed center	48 V
5811420300			closed center	-
5811420400			closed center	-
5811420000			closed center	-
5811421500			closed center	12 V
5811421200			closed center	-
5811421100			closed center	24 V
5811421600			closed center	48 V
5811421300			closed center	-
5811421400			closed center	-
5811421000			closed center	-
5811422500			closed center	12 V
5811422200			closed center	-
5811422100			closed center	24 V
5811422600			closed center	48 V
5811422300			closed center	-
5811422400			closed center	-
5811422000			closed center	-
5811423500			closed center	12 V
5811423200			closed center	-
5811423100			closed center	24 V
5811423600			closed center	48 V
5811423300			closed center	-
5811423400			closed center	-
5811423000			closed center	-

Part No.	Operational voltage AC 50 Hz	Operational voltage AC 60 Hz	Voltage tolerance DC
5811420500	-	-	-10% / +10%
5811420200	24 V	-	-
5811420100	-	-	-10% / +10%
5811420600	-	-	-10% / +10%
5811420300	-	110 V	-
5811420400	230 V	-	-
5811420000	-	-	-
5811421500	-	-	-10% / +10%
5811421200	24 V	-	-
5811421100	-	-	-10% / +10%
5811421600	-	-	-10% / +10%
5811421300	-	110 V	-



Part No.	Operational voltage AC 50 Hz	Operational voltage AC 60 Hz	Voltage tolerance DC
5811421400	230 V	-	-
5811421000	-	-	-
5811422500	-	-	-10% / +10%
5811422200	24 V	-	-
5811422100	-	-	-10% / +10%
5811422600	-	-	-10% / +10%
5811422300	-	110 V	-
5811422400	230 V	-	-
5811422000	-	-	-
5811423500	-	-	-10% / +10%
5811423200	24 V	-	-
5811423100	-	-	-10% / +10%
5811423600	-	-	-10% / +10%
5811423300	-	110 V	-
5811423400	230 V	-	-
5811423000	-	-	-

Part No.	Voltage tolerance AC 50 Hz	Voltage tolerance AC 60 Hz	Power consumption DC	Holding power AC 50 Hz
5811420500	-	-	5 W	-
5811420200	-10% / +10%	-	-	8 VA
5811420100	-	-	5 W	-
5811420600	-	-	5 W	-
5811420300	-	-10% / +10%	-	-
5811420400	-10% / +10%	-	-	8 VA
5811420000	-	-	-	-
5811421500	-	-	5 W	-
5811421200	-10% / +10%	-	-	8 VA
5811421100	-	-	5 W	-
5811421600	-	-	5 W	-
5811421300	-	-10% / +10%	-	-
5811421400	-10% / +10%	-	-	8 VA
5811421000	-	-	-	-
5811422500	-	-	5 W	-
5811422200	-10% / +10%	-	-	8 VA
5811422100	-	-	5 W	-
5811422600	-	-	5 W	-
5811422300	-	-10% / +10%	-	-
5811422400	-10% / +10%	-	-	8 VA
5811422000	-	-	-	-
5811423500	-	-	5 W	-
5811423200	-10% / +10%	-	-	8 VA
5811423100	-	-	5 W	-
5811423600	-	-	5 W	-
5811423300	-	-10% / +10%	-	-
5811423400	-10% / +10%	-	-	8 VA
5811423000	-	-	-	-

Part No.	Holding power AC 60 Hz	Switch-on power AC 50 Hz	Switch-on power AC 60 Hz	Pilot
5811420500	-	-	-	Internal
5811420200	-	10 VA	-	Internal
5811420100	-	-	-	Internal
5811420600	-	-	-	Internal
5811420300	8 VA	-	10 VA	Internal
5811420400	-	10 VA	-	Internal
5811420000	-	-	-	Internal
5811421500	-	-	-	Internal
5811421200	-	10 VA	-	Internal
5811421100	-	-	-	Internal
5811421600	-	-	-	Internal
5811421300	8 VA	-	10 VA	Internal
5811421400	-	10 VA	-	Internal
5811421000	-	-	-	Internal
5811422500	-	-	-	External
5811422200	-	10 VA	-	External
5811422100	-	-	-	External
5811422600	-	-	-	External
5811422300	8 VA	-	10 VA	External
5811422400	-	10 VA	-	External
5811422000	-	-	-	External
5811423500	-	-	-	External
5811423200	-	10 VA	-	External
5811423100	-	-	-	External
5811423600	-	-	-	External
5811423300	8 VA	-	10 VA	External
5811423400	-	10 VA	-	External
5811423000	-	-	-	External

Part No.	Working pressure min./max.	Electrical connection Pilot valve
5811420500	3 ... 10 bar	Plug Form B, industry
5811420200	3 ... 10 bar	Plug Form B, industry
5811420100	3 ... 10 bar	Plug Form B, industry
5811420600	3 ... 10 bar	Plug Form B, industry
5811420300	3 ... 10 bar	Plug Form B, industry
5811420400	3 ... 10 bar	Plug Form B, industry
5811420000	3 ... 10 bar	Plug Form B, industry
5811421500	3 ... 10 bar	Plug Form B, industry
5811421200	3 ... 10 bar	Plug Form B, industry
5811421100	3 ... 10 bar	Plug Form B, industry
5811421600	3 ... 10 bar	Plug Form B, industry
5811421300	3 ... 10 bar	Plug Form B, industry
5811421400	3 ... 10 bar	Plug Form B, industry
5811421000	3 ... 10 bar	Plug Form B, industry
5811422500	-0,95 ... 10 bar	Plug Form B, industry
5811422200	-0,95 ... 10 bar	Plug Form B, industry

Part No.	Working pressure min./max.	Electrical connection Pilot valve
5811422100	-0,95 ... 10 bar	Plug Form B, industry
5811422600	-0,95 ... 10 bar	Plug Form B, industry
5811422300	-0,95 ... 10 bar	Plug Form B, industry
5811422400	-0,95 ... 10 bar	Plug Form B, industry
5811422000	-0,95 ... 10 bar	Plug Form B, industry
5811423500	-0,95 ... 10 bar	Plug Form B, industry
5811423200	-0,95 ... 10 bar	Plug Form B, industry
5811423100	-0,95 ... 10 bar	Plug Form B, industry
5811423600	-0,95 ... 10 bar	Plug Form B, industry
5811423300	-0,95 ... 10 bar	Plug Form B, industry
5811423400	-0,95 ... 10 bar	Plug Form B, industry
5811423000	-0,95 ... 10 bar	Plug Form B, industry

Part No.	basic valve with electrical connector	Throttle
5811420500	-	-
5811420200	-	-
5811420100	-	-
5811420600	-	-
5811420300	-	-
5811420400	-	-
5811420000	Basic valve without coil	-
5811421500	-	with throttle
5811421200	-	with throttle
5811421100	-	with throttle
5811421600	-	with throttle
5811421300	-	with throttle
5811421400	-	with throttle
5811421000	Basic valve without coil	with throttle
5811422500	-	-
5811422200	-	-
5811422100	-	-
5811422600	-	-
5811422300	-	-
5811422400	-	-
5811422000	Basic valve without coil	-
5811423500	-	with throttle
5811423200	-	with throttle
5811423100	-	with throttle
5811423600	-	with throttle
5811423300	-	with throttle
5811423400	-	with throttle
5811423000	Basic valve without coil	with throttle

Nominal flow Qn at 6 bar and  $\Delta p = 1$  bar, MO = Manual override

## Technical information

The min. control pressure must be adhered to, since otherwise faulty switching and valve failure may result!

The pressure dew point must be at least 15 °C under ambient and medium temperature and may not exceed 3 °C .

The oil content of compressed air must remain constant during the life cycle.

Use only the approved oils from AVENTICS. Further information can be found in the "Technical information" document (available in the MediaCentre).

## Technical information

Housing	Polyamide fiber-glass reinforced
Seals	Acrylonitrile butadiene rubber

## Dimensions

### Dimensions

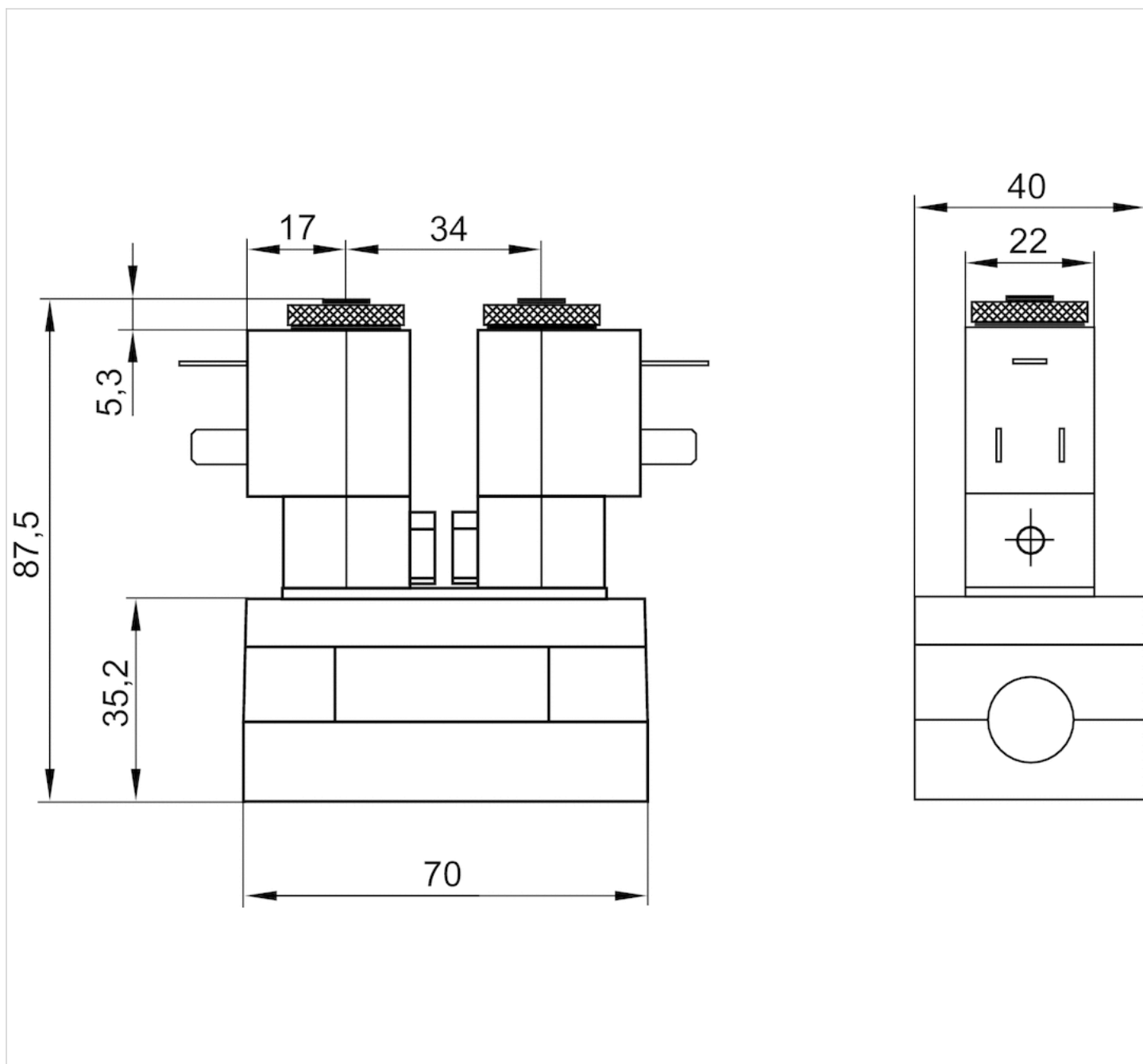

The pilot valves can be loosened and turned through 180°.

# 5/3-directional valve, Series 581, size 1

- ISO 5599-1
- ISO 1
- 5/3
- exhausted center
- $Q_n = 1100$  l/min
- Compressed air connection output Base plate ISO 5599-1
- Electrical connection Plug, Form B, industry
- Manual override with detent



Type	Spool valve
Sealing principle	Soft sealing
Blocking principle	Single base plate principle
Connection type	Plate connection
Standards	ISO 5599-1, ISO 1
Working pressure min./max.	See table below
Control pressure min./max.	3 ... 10 bar
Ambient temperature min./max.	-15 ... 50 °C
Medium temperature min./max.	-15 ... 50 °C
Medium	Compressed air
Max. particle size	50 µm
Oil content of compressed air	0 ... 5 mg/m <sup>3</sup>
Nominal flow $Q_n$	1100 l/min
Flow conductance C	4,3 l/(s*bar)
Protection class with connection	IP65
Duty cycle	100 %
Typ. switch-on time	15 ms
Typ. switch-off time	38 ms
Mounting screw	with hexagon socket
Mounting screw tightening torque	2 Nm
Weight	0,3 kg

## Technical data

Part No.		MO		Operational voltage DC
5811520500			exhausted center	12 V
5811520200			exhausted center	-
5811520100			exhausted center	24 V
5811520600			exhausted center	48 V
5811520300			exhausted center	-
5811520400			exhausted center	-
5811520000			exhausted center	-
5811521500			exhausted center	12 V
5811521200			exhausted center	-
5811521100			exhausted center	24 V
5811521600			exhausted center	48 V
5811521300			exhausted center	-
5811521400			exhausted center	-
5811521000			exhausted center	-
5811522500			exhausted center	12 V
5811522200			exhausted center	-
5811522100			exhausted center	24 V
5811522600			exhausted center	48 V
5811522300			exhausted center	-
5811522400			exhausted center	-
5811522000			exhausted center	-
5811523500			exhausted center	12 V
5811523200			exhausted center	-
5811523100			exhausted center	24 V
5811523600			exhausted center	48 V
5811523300			exhausted center	-
5811523400			exhausted center	-
5811523000			exhausted center	-

Part No.	Operational voltage AC 50 Hz	Operational voltage AC 60 Hz	Voltage tolerance DC
5811520500	-	-	-10% / +10%
5811520200	24 V	-	-
5811520100	-	-	-10% / +10%
5811520600	-	-	-10% / +10%
5811520300	-	110 V	-
5811520400	230 V	-	-
5811520000	-	-	-
5811521500	-	-	-10% / +10%
5811521200	24 V	-	-
5811521100	-	-	-10% / +10%
5811521600	-	-	-10% / +10%
5811521300	-	110 V	-

Part No.	Operational voltage AC 50 Hz	Operational voltage AC 60 Hz	Voltage tolerance DC
5811521400	230 V	-	-
5811521000	-	-	-
5811522500	-	-	-10% / +10%
5811522200	24 V	-	-
5811522100	-	-	-10% / +10%
5811522600	-	-	-10% / +10%
5811522300	-	110 V	-
5811522400	230 V	-	-
5811522000	-	-	-
5811523500	-	-	-10% / +10%
5811523200	24 V	-	-
5811523100	-	-	-10% / +10%
5811523600	-	-	-10% / +10%
5811523300	-	110 V	-
5811523400	230 V	-	-
5811523000	-	-	-

Part No.	Voltage tolerance AC 50 Hz	Voltage tolerance AC 60 Hz	Power consumption DC	Holding power AC 50 Hz
5811520500	-	-	5 W	-
5811520200	-10% / +10%	-	-	8 VA
5811520100	-	-	5 W	-
5811520600	-	-	5 W	-
5811520300	-	-10% / +10%	-	-
5811520400	-10% / +10%	-	-	8 VA
5811520000	-	-	-	-
5811521500	-	-	5 W	-
5811521200	-10% / +10%	-	-	8 VA
5811521100	-	-	5 W	-
5811521600	-	-	5 W	-
5811521300	-	-10% / +10%	-	-
5811521400	-10% / +10%	-	-	8 VA
5811521000	-	-	-	-
5811522500	-	-	5 W	-
5811522200	-10% / +10%	-	-	8 VA
5811522100	-	-	5 W	-
5811522600	-	-	5 W	-
5811522300	-	-10% / +10%	-	-
5811522400	-10% / +10%	-	-	8 VA
5811522000	-	-	-	-
5811523500	-	-	5 W	-
5811523200	-10% / +10%	-	-	8 VA
5811523100	-	-	5 W	-
5811523600	-	-	5 W	-
5811523300	-	-10% / +10%	-	-
5811523400	-10% / +10%	-	-	8 VA
5811523000	-	-	-	-



Part No.	Holding power AC 60 Hz	Switch-on power AC 50 Hz	Switch-on power AC 60 Hz	Pilot
5811520500	-	-	-	Internal
5811520200	-	10 VA	-	Internal
5811520100	-	-	-	Internal
5811520600	-	-	-	Internal
5811520300	8 VA	-	10 VA	Internal
5811520400	-	10 VA	-	Internal
5811520000	-	-	-	Internal
5811521500	-	-	-	Internal
5811521200	-	10 VA	-	Internal
5811521100	-	-	-	Internal
5811521600	-	-	-	Internal
5811521300	8 VA	-	10 VA	Internal
5811521400	-	10 VA	-	Internal
5811521000	-	-	-	Internal
5811522500	-	-	-	External
5811522200	-	10 VA	-	External
5811522100	-	-	-	External
5811522600	-	-	-	External
5811522300	8 VA	-	10 VA	External
5811522400	-	10 VA	-	External
5811522000	-	-	-	External
5811523500	-	-	-	External
5811523200	-	10 VA	-	External
5811523100	-	-	-	External
5811523600	-	-	-	External
5811523300	8 VA	-	10 VA	External
5811523400	-	10 VA	-	External
5811523000	-	-	-	External

Part No.	Working pressure min./max.	Electrical connection Pilot valve
5811520500	3 ... 10 bar	Plug Form B, industry
5811520200	3 ... 10 bar	Plug Form B, industry
5811520100	3 ... 10 bar	Plug Form B, industry
5811520600	3 ... 10 bar	Plug Form B, industry
5811520300	3 ... 10 bar	Plug Form B, industry
5811520400	3 ... 10 bar	Plug Form B, industry
5811520000	3 ... 10 bar	Plug Form B, industry
5811521500	3 ... 10 bar	Plug Form B, industry
5811521200	3 ... 10 bar	Plug Form B, industry
5811521100	3 ... 10 bar	Plug Form B, industry
5811521600	3 ... 10 bar	Plug Form B, industry
5811521300	3 ... 10 bar	Plug Form B, industry
5811521400	3 ... 10 bar	Plug Form B, industry
5811521000	3 ... 10 bar	Plug Form B, industry
5811522500	-0,95 ... 10 bar	Plug Form B, industry
5811522200	-0,95 ... 10 bar	Plug Form B, industry

Part No.	Working pressure min./max.	Electrical connection Pilot valve
5811522100	-0,95 ... 10 bar	Plug Form B, industry
5811522600	-0,95 ... 10 bar	Plug Form B, industry
5811522300	-0,95 ... 10 bar	Plug Form B, industry
5811522400	-0,95 ... 10 bar	Plug Form B, industry
5811522000	-0,95 ... 10 bar	Plug Form B, industry
5811523500	-0,95 ... 10 bar	Plug Form B, industry
5811523200	-0,95 ... 10 bar	Plug Form B, industry
5811523100	-0,95 ... 10 bar	Plug Form B, industry
5811523600	-0,95 ... 10 bar	Plug Form B, industry
5811523300	-0,95 ... 10 bar	Plug Form B, industry
5811523400	-0,95 ... 10 bar	Plug Form B, industry
5811523000	-0,95 ... 10 bar	Plug Form B, industry

Part No.	basic valve with electrical connector	Throttle
5811520500	-	-
5811520200	-	-
5811520100	-	-
5811520600	-	-
5811520300	-	-
5811520400	-	-
5811520000	Basic valve without coil	-
5811521500	-	with throttle
5811521200	-	with throttle
5811521100	-	with throttle
5811521600	-	with throttle
5811521300	-	with throttle
5811521400	-	with throttle
5811521000	Basic valve without coil	with throttle
5811522500	-	-
5811522200	-	-
5811522100	-	-
5811522600	-	-
5811522300	-	-
5811522400	-	-
5811522000	Basic valve without coil	-
5811523500	-	with throttle
5811523200	-	with throttle
5811523100	-	with throttle
5811523600	-	with throttle
5811523300	-	with throttle
5811523400	-	with throttle
5811523000	Basic valve without coil	with throttle

Nominal flow Qn at 6 bar and  $\Delta p = 1$  bar, MO = Manual override

## Technical information

The min. control pressure must be adhered to, since otherwise faulty switching and valve failure may result!

The pressure dew point must be at least 15 °C under ambient and medium temperature and may not exceed 3 °C .

The oil content of compressed air must remain constant during the life cycle.

Use only the approved oils from AVENTICS. Further information can be found in the "Technical information" document (available in the MediaCentre).

## Technical information

Housing	Polyamide fiber-glass reinforced
Seals	Acrylonitrile butadiene rubber

## Dimensions

### Dimensions

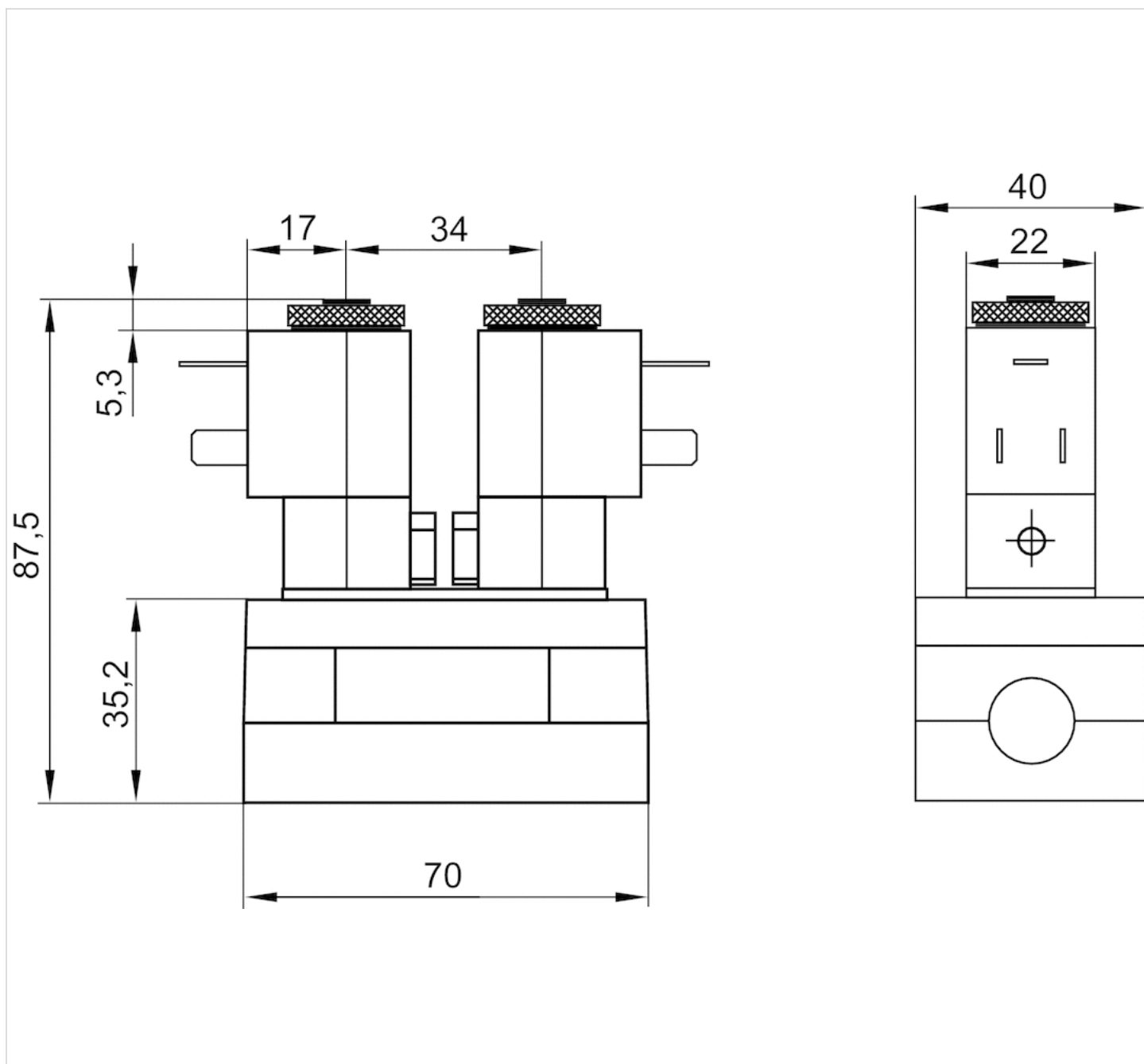

The pilot valves can be loosened and turned through 180°.











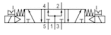

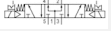

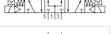

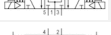

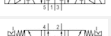



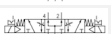

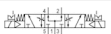

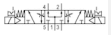

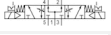

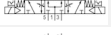

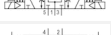

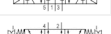

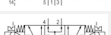

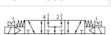



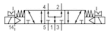





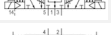

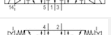

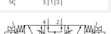

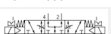

# 5/3-directional valve, Series 581, size 1

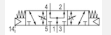
- ISO 5599-1
- ISO 1
- 5/3
- pressurized center
- $Q_n = 1100$  l/min
- Compressed air connection output Base plate ISO 5599-1
- Electrical connection Plug, Form B, industry
- Manual override with detent



Type	Spool valve
Sealing principle	Soft sealing
Blocking principle	Single base plate principle
Connection type	Plate connection
Standards	ISO 5599-1, ISO 1
Working pressure min./max.	See table below
Control pressure min./max.	3 ... 10 bar
Ambient temperature min./max.	-15 ... 50 °C
Medium temperature min./max.	-15 ... 50 °C
Medium	Compressed air
Max. particle size	50 µm
Oil content of compressed air	0 ... 5 mg/m <sup>3</sup>
Nominal flow $Q_n$	1100 l/min
Flow conductance C	4,3 l/(s*bar)
Protection class with connection	IP65
Duty cycle	100 %
Typ. switch-on time	14 ms
Typ. switch-off time	32 ms
Mounting screw	with hexagon socket
Mounting screw tightening torque	2 Nm
Weight	0,3 kg

## Technical data

Part No.		MO		Operational voltage DC
5811720500			pressurized center	12 V
5811720200			pressurized center	-
5811720100			pressurized center	24 V
5811720600			pressurized center	48 V
5811720300			pressurized center	-
5811720400			pressurized center	-
5811720000			pressurized center	-
5811721500			pressurized center	12 V
5811721200			pressurized center	-
5811721100			pressurized center	24 V
5811721600			pressurized center	48 V
5811721300			pressurized center	-
5811721400			pressurized center	-
5811721000			pressurized center	-
5811722500			pressurized center	12 V
5811722200			pressurized center	-
5811722100			pressurized center	24 V
5811722600			pressurized center	48 V
5811722300			pressurized center	-
5811722400			pressurized center	-
5811722000			pressurized center	-
5811723500			pressurized center	12 V
5811723200			pressurized center	-
5811723100			pressurized center	24 V
5811723600			pressurized center	48 V
5811723300			pressurized center	-
5811723400			pressurized center	-
5811723000			pressurized center	-

Part No.	Operational voltage AC 50 Hz	Operational voltage AC 60 Hz	Voltage tolerance DC
5811720500	-	-	-10% / +10%
5811720200	24 V	-	-
5811720100	-	-	-10% / +10%
5811720600	-	-	-10% / +10%
5811720300	-	110 V	-
5811720400	230 V	-	-
5811720000	-	-	-
5811721500	-	-	-10% / +10%
5811721200	24 V	-	-
5811721100	-	-	-10% / +10%
5811721600	-	-	-10% / +10%
5811721300	-	110 V	-

Part No.	Operational voltage AC 50 Hz	Operational voltage AC 60 Hz	Voltage tolerance DC
5811721400	230 V	-	-
5811721000	-	-	-
5811722500	-	-	-10% / +10%
5811722200	24 V	-	-
5811722100	-	-	-10% / +10%
5811722600	-	-	-10% / +10%
5811722300	-	110 V	-
5811722400	230 V	-	-
5811722000	-	-	-
5811723500	-	-	-10% / +10%
5811723200	24 V	-	-
5811723100	-	-	-10% / +10%
5811723600	-	-	-10% / +10%
5811723300	-	110 V	-
5811723400	230 V	-	-
5811723000	230 V	-	-

Part No.	Voltage tolerance AC 50 Hz	Voltage tolerance AC 60 Hz	Power consumption DC	Holding power AC 50 Hz
5811720500	-	-	5 W	-
5811720200	-10% / +10%	-	-	8 VA
5811720100	-	-	5 W	-
5811720600	-	-	5 W	-
5811720300	-	-10% / +10%	-	-
5811720400	-10% / +10%	-	-	8 VA
5811720000	-	-	-	-
5811721500	-	-	5 W	-
5811721200	-10% / +10%	-	-	8 VA
5811721100	-	-	5 W	-
5811721600	-	-	5 W	-
5811721300	-	-10% / +10%	-	-
5811721400	-10% / +10%	-	-	8 VA
5811721000	-	-	-	-
5811722500	-	-	5 W	-
5811722200	-10% / +10%	-	-	8 VA
5811722100	-	-	5 W	-
5811722600	-	-	5 W	-
5811722300	-	-10% / +10%	-	-
5811722400	-10% / +10%	-	-	8 VA
5811722000	-	-	-	-
5811723500	-	-	5 W	-
5811723200	-10% / +10%	-	-	8 VA
5811723100	-	-	5 W	-
5811723600	-	-	5 W	-
5811723300	-	-10% / +10%	-	-
5811723400	-10% / +10%	-	-	8 VA
5811723000	-10% / +10%	-	-	8 VA

Part No.	Holding power AC 60 Hz	Switch-on power AC 50 Hz	Switch-on power AC 60 Hz	Pilot
5811720500	-	-	-	Internal
5811720200	-	10 VA	-	Internal
5811720100	-	-	-	Internal
5811720600	-	-	-	Internal
5811720300	8 VA	-	10 VA	Internal
5811720400	-	10 VA	-	Internal
5811720000	-	-	-	Internal
5811721500	-	-	-	Internal
5811721200	-	10 VA	-	Internal
5811721100	-	-	-	Internal
5811721600	-	-	-	Internal
5811721300	8 VA	-	10 VA	Internal
5811721400	-	10 VA	-	Internal
5811721000	-	-	-	Internal
5811722500	-	-	-	External
5811722200	-	10 VA	-	External
5811722100	-	-	-	External
5811722600	-	-	-	External
5811722300	8 VA	-	10 VA	External
5811722400	-	10 VA	-	External
5811722000	-	-	-	External
5811723500	-	-	-	External
5811723200	-	10 VA	-	External
5811723100	-	-	-	External
5811723600	-	-	-	External
5811723300	8 VA	-	10 VA	External
5811723400	-	10 VA	-	External
5811723000	-	10 VA	-	External

Part No.	Working pressure min./max.	Electrical connection Pilot valve
5811720500	3 ... 10 bar	Plug Form B, industry
5811720200	3 ... 10 bar	Plug Form B, industry
5811720100	3 ... 10 bar	Plug Form B, industry
5811720600	3 ... 10 bar	Plug Form B, industry
5811720300	3 ... 10 bar	Plug Form B, industry
5811720400	3 ... 10 bar	Plug Form B, industry
5811720000	3 ... 10 bar	Plug Form B, industry
5811721500	3 ... 10 bar	Plug Form B, industry
5811721200	3 ... 10 bar	Plug Form B, industry
5811721100	3 ... 10 bar	Plug Form B, industry
5811721600	3 ... 10 bar	Plug Form B, industry
5811721300	3 ... 10 bar	Plug Form B, industry
5811721400	3 ... 10 bar	Plug Form B, industry
5811721000	3 ... 10 bar	Plug Form B, industry
5811722500	-0,95 ... 10 bar	Plug Form B, industry
5811722200	-0,95 ... 10 bar	Plug Form B, industry



Part No.	Working pressure min./max.	Electrical connection Pilot valve
5811722100	-0,95 ... 10 bar	Plug Form B, industry
5811722600	-0,95 ... 10 bar	Plug Form B, industry
5811722300	-0,95 ... 10 bar	Plug Form B, industry
5811722400	-0,95 ... 10 bar	Plug Form B, industry
5811722000	-0,95 ... 10 bar	Plug Form B, industry
5811723500	-0,95 ... 10 bar	Plug Form B, industry
5811723200	-0,95 ... 10 bar	Plug Form B, industry
5811723100	-0,95 ... 10 bar	Plug Form B, industry
5811723600	-0,95 ... 10 bar	Plug Form B, industry
5811723300	-0,95 ... 10 bar	Plug Form B, industry
5811723400	-0,95 ... 10 bar	Plug Form B, industry
5811723000	-0,95 ... 10 bar	Plug Form B, industry

Part No.	basic valve with electrical connector	Throttle
5811720500	-	-
5811720200	-	-
5811720100	-	-
5811720600	-	-
5811720300	-	-
5811720400	-	-
5811720000	Basic valve without coil	-
5811721500	-	with throttle
5811721200	-	with throttle
5811721100	-	with throttle
5811721600	-	with throttle
5811721300	-	with throttle
5811721400	-	with throttle
5811721000	Basic valve without coil	with throttle
5811722500	-	-
5811722200	-	-
5811722100	-	-
5811722600	-	-
5811722300	-	-
5811722400	-	-
5811722000	Basic valve without coil	-
5811723500	-	with throttle
5811723200	-	with throttle
5811723100	-	with throttle
5811723600	-	with throttle
5811723300	-	with throttle
5811723400	-	with throttle
5811723000	Basic valve without coil	with throttle

Nominal flow Qn at 6 bar and  $\Delta p = 1$  bar, MO = Manual override

## Technical information

The min. control pressure must be adhered to, since otherwise faulty switching and valve failure may result!

The pressure dew point must be at least 15 °C under ambient and medium temperature and may not exceed 3 °C .

The oil content of compressed air must remain constant during the life cycle.

Use only the approved oils from AVENTICS. Further information can be found in the "Technical information" document (available in the MediaCentre).

## Technical information

Housing	Polyamide fiber-glass reinforced
Seals	Acrylonitrile butadiene rubber

## Dimensions

### Dimensions

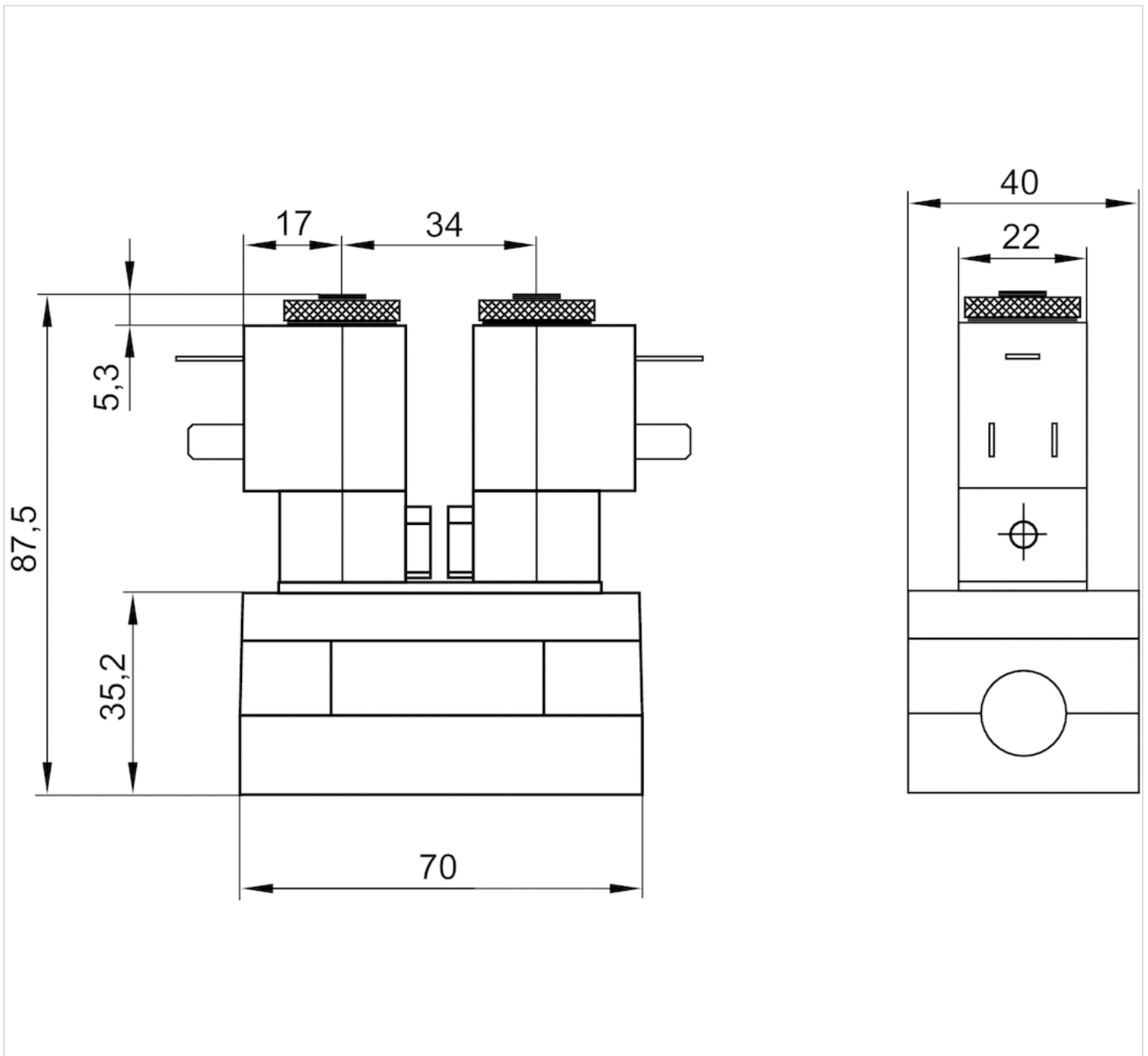

The pilot valves can be loosened and turned through 180°.

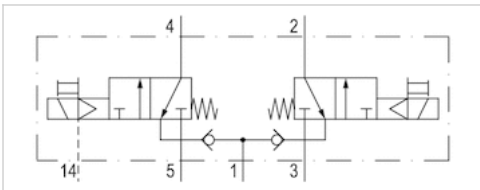

# 2x3/2-directional valve, Series 581, size 1

- ISO 5599-1
- ISO 1
- 2x3/2
- $Q_n = 950 \text{ l/min}$
- Compressed air connection output Base plate ISO 5599-1
- Electrical connection Plug, EN 175301-803, form A
- Manual override without detent



Type	Spool valve
Pilot	External
Sealing principle	Soft sealing
Blocking principle	Single base plate principle
Connection type	Plate connection
Standards	ISO 5599-1, ISO 1
Working pressure min./max.	0 ... 8 bar
Control pressure min./max.	3,5 ... 8 bar
Ambient temperature min./max.	-15 ... 50 °C
Medium temperature min./max.	-15 ... 50 °C
Medium	Compressed air
Max. particle size	50 µm
Oil content of compressed air	0 ... 5 mg/m <sup>3</sup>
Nominal flow $Q_n$	950 l/min
Flow conductance C	3,2 l/(s*bar)
Protection class with connection	IP65
Duty cycle	100 %
Typ. switch-on time	12 ms
Typ. switch-off time	29 ms
Mounting screw	with hexagon socket
Mounting screw tightening torque	2 Nm
Weight	0,5 kg

## Technical data

Part No.	MO	Operational voltage DC	Operational voltage AC 50 Hz	Voltage tolerance DC
R402003717		24 V	42 V	-10% / +10%
R402003716		-	230 V	-

Part No.	Voltage tolerance AC 50 Hz	Power consumption DC	Holding power AC 50 Hz	Switch-on power AC 50 Hz
R402003717	-10% / +10%	6,7 W	7,7 VA	12 VA
R402003716	-10% / +10%	-	10,8 VA	15,2 VA

Part No.	Electrical connection Pilot valve

Part No.	Electrical connection Pilot valve
R402003717	Plug EN 175301-803, form A
R402003716	Plug EN 175301-803, form A

The valve must be supplied with compressed air via ports 3 and 5, Nominal flow Qn at 6 bar and  $\Delta p = 1$  bar, MO = Manual override

## Technical information

The min. control pressure must be adhered to, since otherwise faulty switching and valve failure may result!

The pressure dew point must be at least 15 °C under ambient and medium temperature and may not exceed 3 °C .

The oil content of compressed air must remain constant during the life cycle.

Use only the approved oils from AVENTICS. Further information can be found in the "Technical information" document (available in the MediaCentre).

## Technical information

Housing	Aluminum
Seals	Acrylonitrile butadiene rubber

# Dimensions

## Dimensions

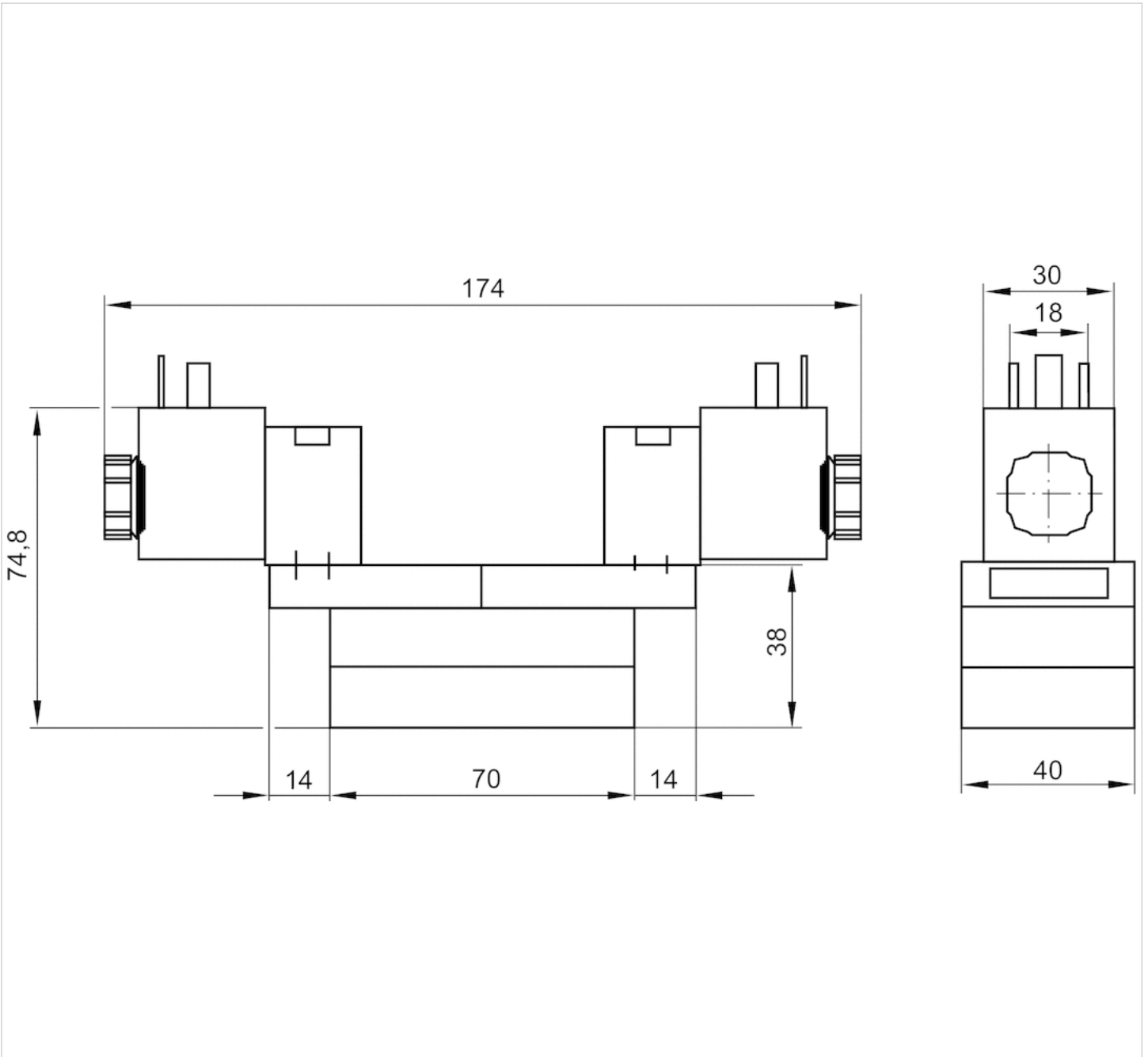

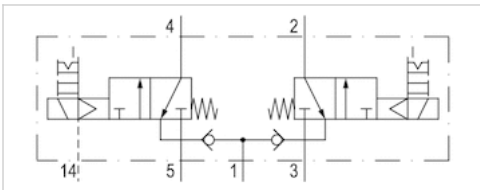

# 2x3/2-directional valve, Series 581, size 1

- ISO 5599-1
- ISO 1
- 2x3/2
- Qn = 950 l/min
- Compressed air connection output Base plate ISO 5599-1
- Electrical connection Plug, EN 175301-803, form A
- Manual override with detent, without detent



Type	Spool valve
Pilot	External
Sealing principle	Soft sealing
Blocking principle	Single base plate principle
Connection type	Plate connection
Standards	ISO 5599-1, ISO 1
Working pressure min./max.	0 ... 8 bar
Control pressure min./max.	3,5 ... 8 bar
Ambient temperature min./max.	-15 ... 50 °C
Medium temperature min./max.	-15 ... 50 °C
Medium	Compressed air
Max. particle size	50 µm
Oil content of compressed air	0 ... 5 mg/m <sup>3</sup>
Nominal flow Qn	950 l/min
Flow conductance C	3,2 l/(s*bar)
Protection class with connection	IP65
Compatibility index	14
Duty cycle	100 %
Typ. switch-on time	12 ms
Typ. switch-off time	29 ms
Mounting screw	with hexagon socket
Mounting screw tightening torque	2 Nm
Weight	0,5 kg

## Technical data

Part No.	MO	Operational voltage DC	Operational voltage AC 50 Hz	Voltage tolerance DC
R402003719		24 V	-	-10% / +10%
R402003718		-	230 V	-

Part No.	Voltage tolerance AC 50 Hz	Power consumption DC	Holding power AC 50 Hz	Switch-on power AC 50 Hz
R402003719	-	2 W	-	-
R402003718	-10% / +10%	-	4,8 VA	7 VA

Part No.	Compatibility index	Electrical connection Pilot valve
R402003719	14	Plug EN 175301-803, form A
R402003718	14	Plug EN 175301-803, form A

The valve must be supplied with compressed air via ports 3 and 5, Nominal flow Qn at 6 bar and  $\Delta p = 1$  bar, MO = Manual override

## Technical information

The min. control pressure must be adhered to, since otherwise faulty switching and valve failure may result!

The pressure dew point must be at least 15 °C under ambient and medium temperature and may not exceed 3 °C .

The oil content of compressed air must remain constant during the life cycle.

Use only the approved oils from AVENTICS. Further information can be found in the "Technical information" document (available in the MediaCentre).

## Technical information

Housing	Aluminum
Seals	Acrylonitrile butadiene rubber



# Dimensions

## Dimensions

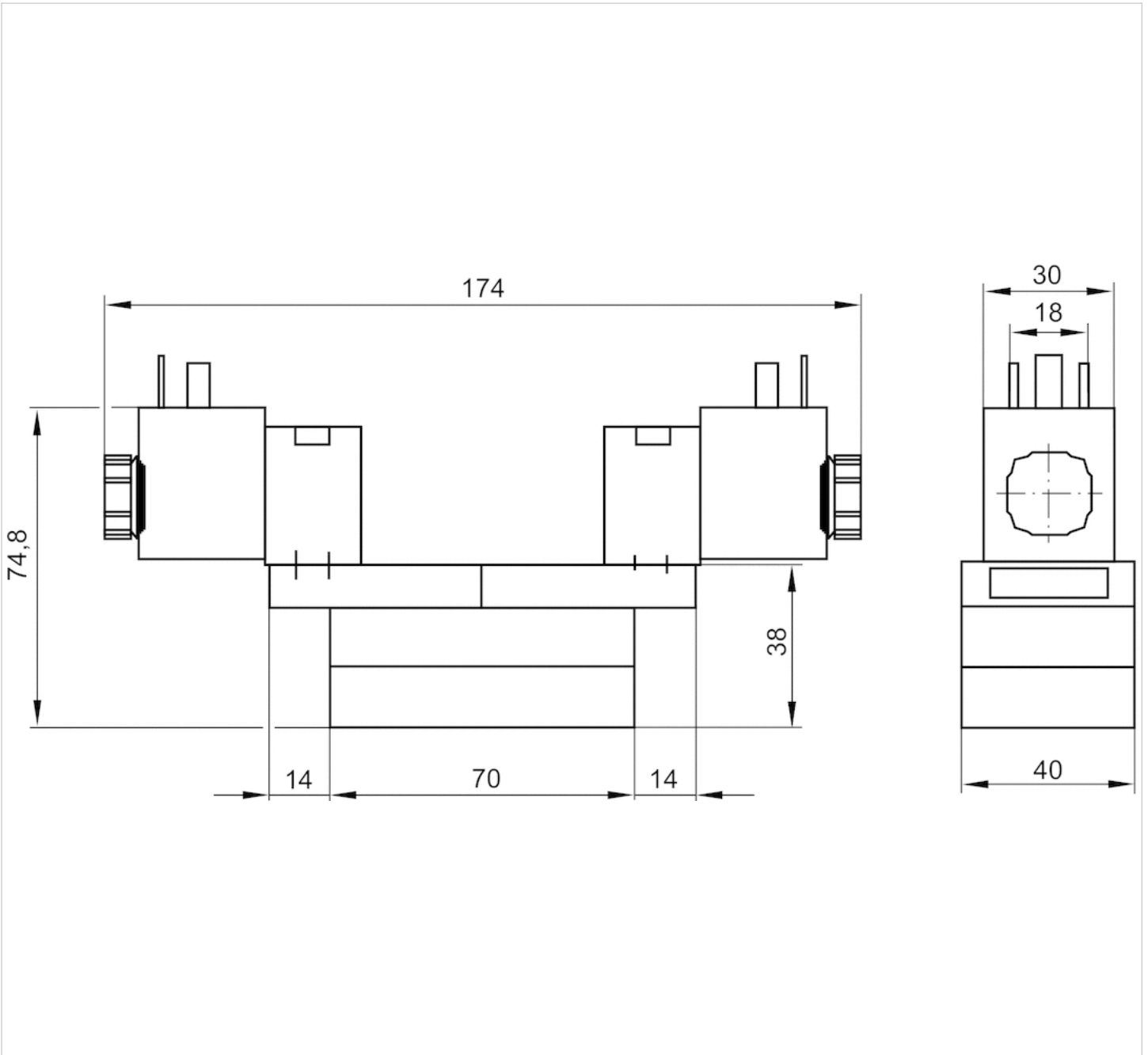

# 2x3/2-directional valve, Series 581, size 1

- ISO 5599-1
- ISO 1
- 2x3/2
- $Q_n = 950$  l/min
- Compressed air connection output Base plate ISO 5599-1
- Electrical connection Plug, EN 175301-803, form A
- Manual override without

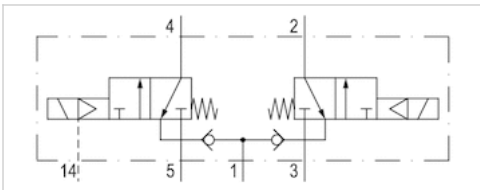

Type	Spool valve
Pilot	External
Sealing principle	Soft sealing
Blocking principle	Single base plate principle
Connection type	Plate connection
Standards	ISO 5599-1, ISO 1
Working pressure min./max.	0 ... 8 bar
Control pressure min./max.	3,5 ... 8 bar
Ambient temperature min./max.	-15 ... 50 °C
Medium temperature min./max.	-15 ... 50 °C
Medium	Compressed air
Max. particle size	50 µm
Oil content of compressed air	0 ... 5 mg/m <sup>3</sup>
Nominal flow $Q_n$	950 l/min
Flow conductance C	3,2 l/(s*bar)
Protection class with connection	IP65
Duty cycle	100 %
Typ. switch-on time	12 ms
Typ. switch-off time	29 ms
Mounting screw	with hexagon socket
Mounting screw tightening torque	2 Nm
Weight	0,5 kg

## Technical data

Part No.	Operational voltage DC	Operational voltage AC 50 Hz	Voltage tolerance DC
R402003721	24 V	-	-10% / +10%
R402003720	-	230 V	-

Part No.	Voltage tolerance AC 50 Hz	Power consumption DC	Holding power AC 50 Hz	Switch-on power AC 50 Hz
R402003721	-	6,7 W	-	-
R402003720	-10% / +10%	-	10,8 VA	15,2 VA

Part No.	Electrical connection Pilot valve

Part No.	Electrical connection Pilot valve
R402003721	Plug EN 175301-803, form A
R402003720	Plug EN 175301-803, form A

The valve must be supplied with compressed air via ports 3 and 5, Nominal flow Qn at 6 bar and  $\Delta p = 1$  bar

## Technical information

The min. control pressure must be adhered to, since otherwise faulty switching and valve failure may result!

The pressure dew point must be at least 15 °C under ambient and medium temperature and may not exceed 3 °C .

The oil content of compressed air must remain constant during the life cycle.

Use only the approved oils from AVENTICS. Further information can be found in the "Technical information" document (available in the MediaCentre).

## Technical information

Housing	Aluminum
Seals	Acrylonitrile butadiene rubber

# Dimensions

## Dimensions

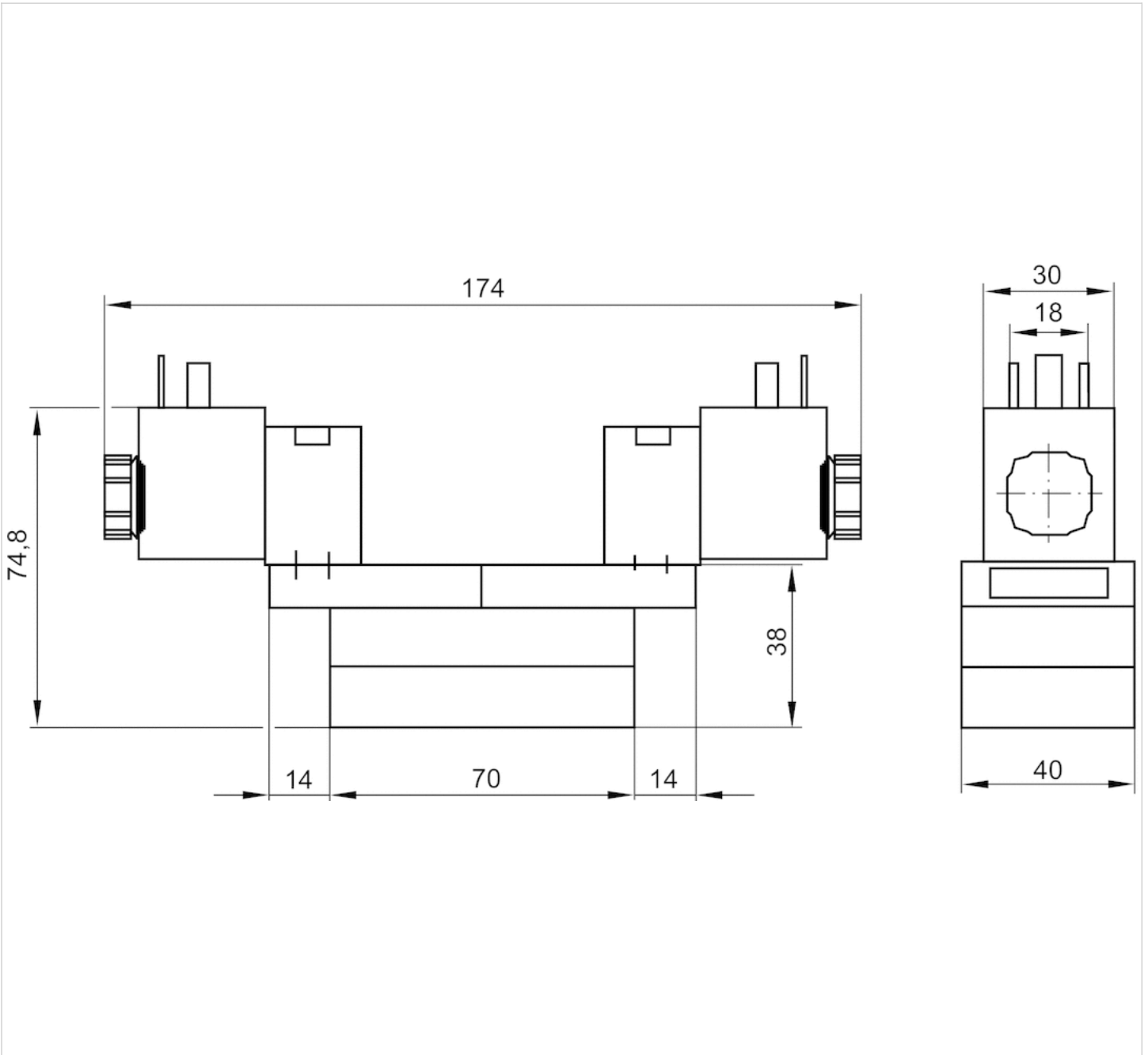

# 2x3/2-directional valve, Series 581, size 1

- ISO 5599-1
- ISO 1
- 2x3/2
- NC/NC
- Qn = 950 l/min
- Compressed air connection output Base plate ISO 5599-1
- Electrical connection Plug, EN 175301-803, form A
- Manual override without detent

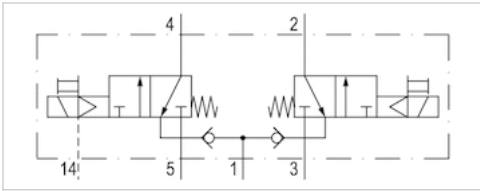

Type	Spool valve
Pilot	External
Sealing principle	Soft sealing
Blocking principle	Single base plate principle
Connection type	Plate connection
Standards	ISO 5599-1, ISO 1
Working pressure min./max.	0 ... 8 bar
Control pressure min./max.	3,5 ... 8 bar
Ambient temperature min./max.	-15 ... 50 °C
Medium temperature min./max.	-15 ... 50 °C
Medium	Compressed air
Max. particle size	50 µm
Oil content of compressed air	0 ... 5 mg/m <sup>3</sup>
Nominal flow Qn	950 l/min
Flow conductance C	3,2 l/(s*bar)
Protection class with connection	IP65
Duty cycle	100 %
Typ. switch-on time	12 ms
Typ. switch-off time	29 ms
Mounting screw	with hexagon socket
Mounting screw tightening torque	2 Nm
Weight	0,58 kg

## Technical data

Part No.	MO		Operational voltage DC	Voltage tolerance DC
R402003722		NC/NC	24 V	-10% / +10%

Part No.	Power consumption DC	Electrical connection Pilot valve
R402003722	6 W	Plug EN 175301-803, form A

The valve must be supplied with compressed air via ports 3 and 5, Nominal flow Qn at 6 bar and  $\Delta p = 1$  bar, MO = Manual override

## Technical information

The min. control pressure must be adhered to, since otherwise faulty switching and valve failure may result!

The pressure dew point must be at least 15 °C under ambient and medium temperature and may not exceed 3 °C .

The oil content of compressed air must remain constant during the life cycle.

Use only the approved oils from AVENTICS. Further information can be found in the “Technical information” document (available in the MediaCentre).

## Technical information

Housing	Aluminum
Seals	Acrylonitrile butadiene rubber

# Dimensions

## Dimensions

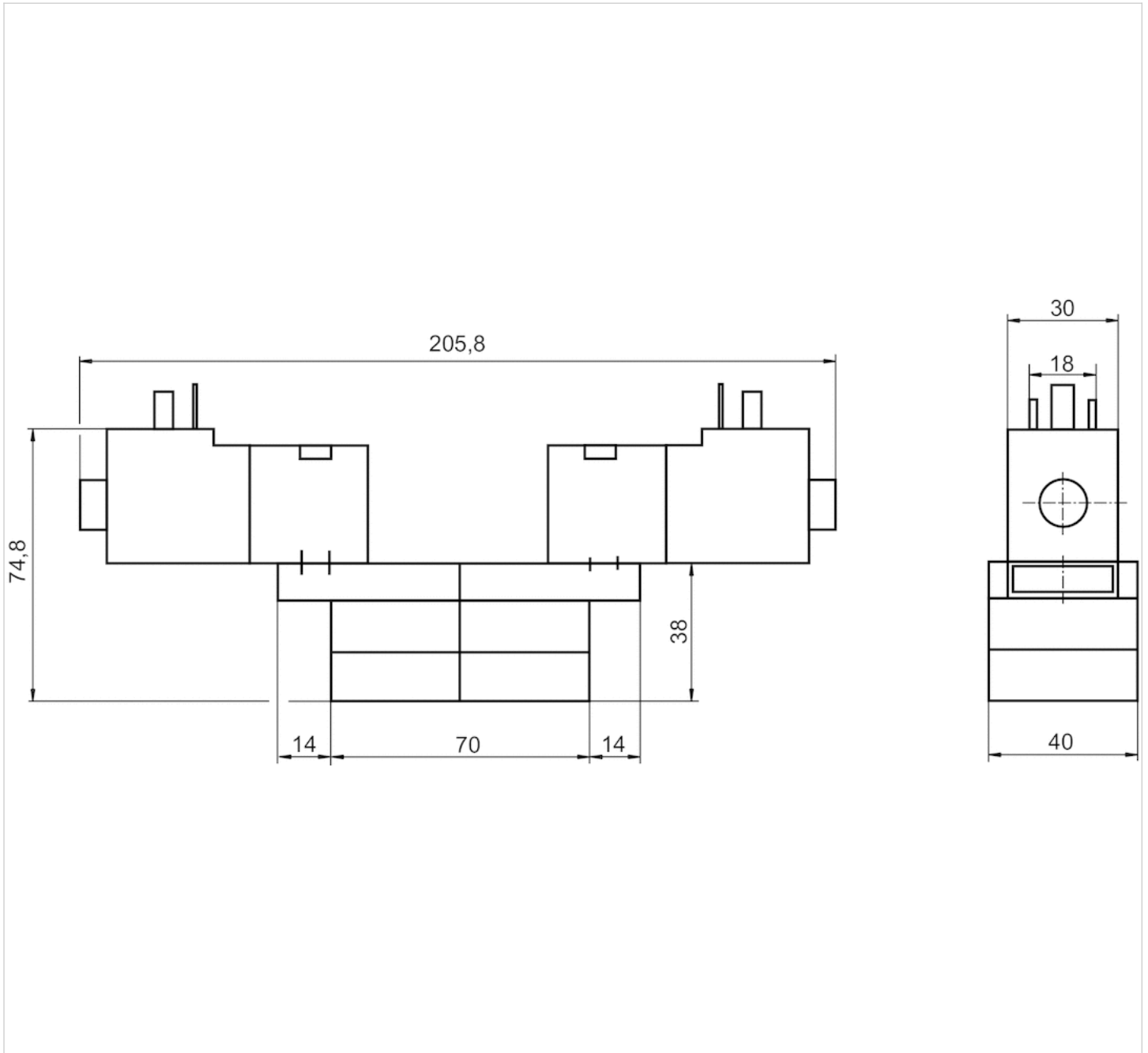

# 5/2-directional valve, Series 581, size 1

- ISO 5599-1
- ISO 1
- 5/2
- With spring return
- single solenoid
- Qn = 1400 l/min
- Compressed air connection output Base plate ISO 5599-1
- Electrical connection Plug, EN 175301-803, form A
- Manual override without detent



Type	Spool valve
Sealing principle	Soft sealing
Blocking principle	Single base plate principle
Connection type	Plate connection
Standards	ISO 5599-1, ISO 1
Working pressure min./max.	See table below
Control pressure min./max.	3 ... 16 bar
Ambient temperature min./max.	-15 ... 50 °C
Medium temperature min./max.	-15 ... 50 °C
Medium	Compressed air
Max. particle size	50 µm
Oil content of compressed air	0 ... 5 mg/m <sup>3</sup>
Nominal flow Qn	1400 l/min
Flow conductance C	5,2 l/(s*bar)
Protection class with connection	IP65
Duty cycle	100 %
Typ. switch-on time	15 ms
Typ. switch-off time	28 ms
Mounting screw	with hexagon socket
Mounting screw tightening torque	2 Nm
Weight	0,35 kg

## Technical data

Part No.		MO	Operational voltage DC	Operational voltage AC 50 Hz
5811170540			24 V	42 V
5811170440			-	230 V
5811171540			24 V	42 V
5811171440			-	230 V
5811172540			24 V	42 V
5811172440			-	230 V
5811173540			24 V	42 V
5811173440			-	230 V



Part No.	Voltage tolerance DC	Voltage tolerance AC 50 Hz	Power consumption DC	Holding power AC 50 Hz
5811170540	-10% / +10%	-10% / +10%	6,7 W	7,7 VA
5811170440	-	-10% / +10%	-	10,8 VA
5811171540	-10% / +10%	-10% / +10%	6,7 W	7,7 VA
5811171440	-	-10% / +10%	-	10,8 VA
5811172540	-10% / +10%	-10% / +10%	6,7 W	7,7 VA
5811172440	-	-10% / +10%	-	10,8 VA
5811173540	-10% / +10%	-10% / +10%	6,7 W	7,7 VA
5811173440	-	-10% / +10%	-	10,8 VA

Part No.	Switch-on power AC 50 Hz	Pilot	Working pressure min./max.
5811170540	12 VA	Internal	3 ... 16 bar
5811170440	15,2 VA	Internal	3 ... 16 bar
5811171540	12 VA	Internal	3 ... 16 bar
5811171440	15,2 VA	Internal	3 ... 16 bar
5811172540	12 VA	External	-0,95 ... 16 bar
5811172440	15,2 VA	External	-0,95 ... 16 bar
5811173540	12 VA	External	-0,95 ... 16 bar
5811173440	15,2 VA	External	-0,95 ... 16 bar

Part No.	Electrical connection Pilot valve	Throttle
5811170540	Plug EN 175301-803, form A	-
5811170440	Plug EN 175301-803, form A	-
5811171540	Plug EN 175301-803, form A	with throttle
5811171440	Plug EN 175301-803, form A	with throttle
5811172540	Plug EN 175301-803, form A	-
5811172440	Plug EN 175301-803, form A	-
5811173540	Plug EN 175301-803, form A	with throttle
5811173440	Plug EN 175301-803, form A	with throttle

Nominal flow  $Q_n$  at 6 bar and  $\Delta p = 1$  bar, MO = Manual override

## Technical information

The min. control pressure must be adhered to, since otherwise faulty switching and valve failure may result!

The pressure dew point must be at least 15 °C under ambient and medium temperature and may not exceed 3 °C .

The oil content of compressed air must remain constant during the life cycle.

Use only the approved oils from AVENTICS. Further information can be found in the "Technical information" document (available in the MediaCentre).

## Technical information

Housing	Aluminum
Seals	Acrylonitrile butadiene rubber

## Dimensions

### Dimensions

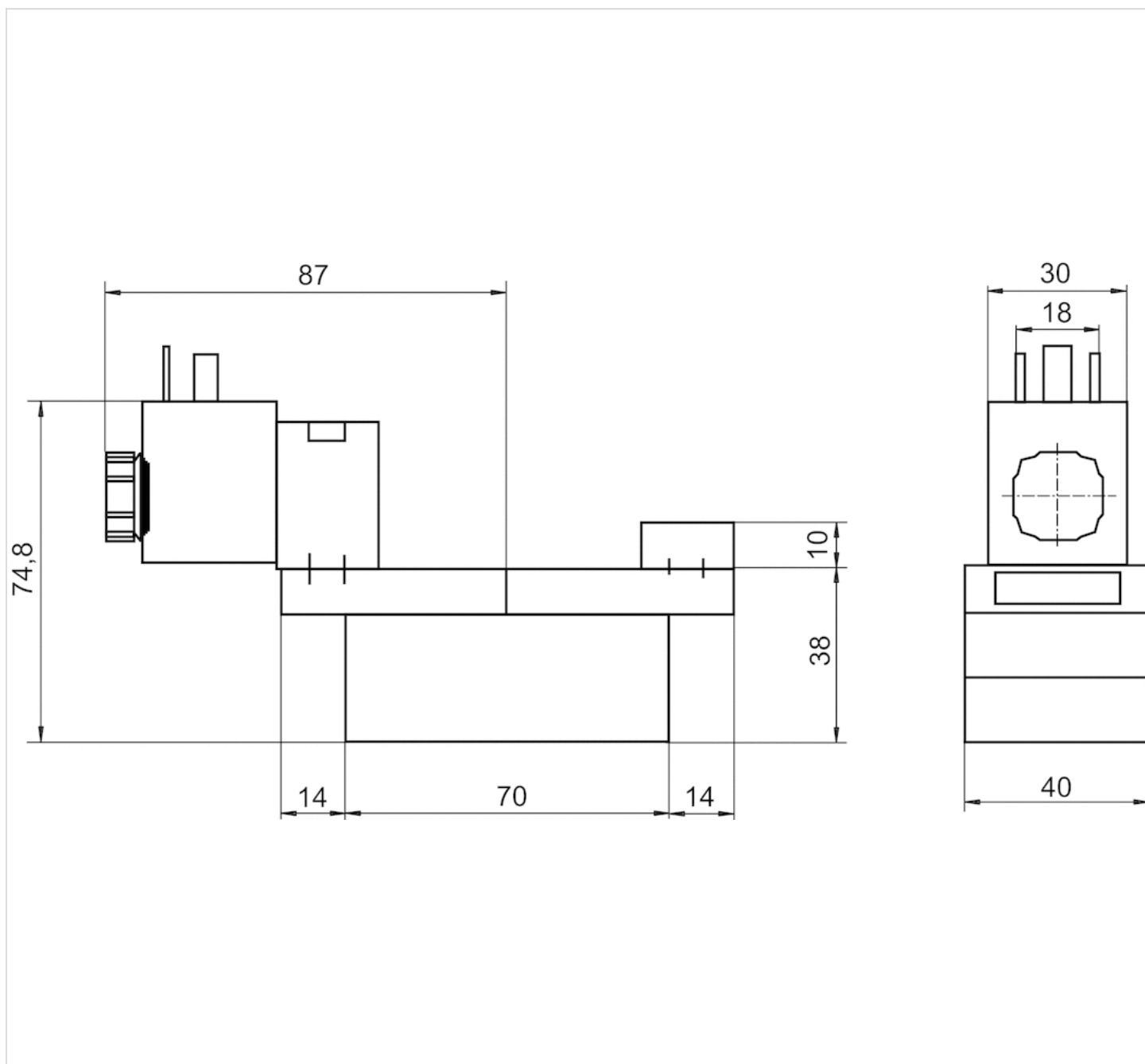

















# 5/2-directional valve, Series 581, size 1

- ISO 5599-1
- ISO 1
- 5/2
- double solenoid
- Qn = 1400 l/min
- Compressed air connection output Base plate ISO 5599-1
- Electrical connection Plug, EN 175301-803, form A
- Manual override without detent



Type	Spool valve
Sealing principle	Soft sealing
Blocking principle	Single base plate principle
Connection type	Plate connection
Standards	ISO 5599-1, ISO 1
Working pressure min./max.	See table below
Control pressure min./max.	1,5 ... 16 bar
Ambient temperature min./max.	-15 ... 50 °C
Medium temperature min./max.	-15 ... 50 °C
Medium	Compressed air
Max. particle size	50 µm
Oil content of compressed air	0 ... 5 mg/m <sup>3</sup>
Nominal flow Qn	1400 l/min
Flow conductance C	5,2 l/(s*bar)
Protection class with connection	IP65
Duty cycle	100 %
Typ. switch-on time	13 ms
Typ. switch-off time	13 ms
Mounting screw	with hexagon socket
Mounting screw tightening torque	2 Nm
Weight	0,5 kg

## Technical data

Part No.		MO	Operational voltage DC	Operational voltage AC 50 Hz
5811290540			24 V	42 V
5811290440			-	230 V
5811291540			24 V	42 V
5811291440			-	230 V
5811292540			24 V	42 V
5811292440			-	230 V
5811293540			24 V	42 V
5811293440			-	230 V

Part No.	Voltage tolerance DC	Voltage tolerance AC 50 Hz	Power consumption DC	Holding power AC 50 Hz
5811290540	-10% / +10%	-10% / +10%	6,7 W	7,7 VA

Part No.	Voltage tolerance DC	Voltage tolerance AC 50 Hz	Power consumption DC	Holding power AC 50 Hz
5811290440	-	-10% / +10%	-	10,8 VA
5811291540	-10% / +10%	-10% / +10%	6,7 W	7,7 VA
5811291440	-	-10% / +10%	-	10,8 VA
5811292540	-10% / +10%	-10% / +10%	6,7 W	7,7 VA
5811292440	-	-10% / +10%	-	10,8 VA
5811293540	-10% / +10%	-10% / +10%	6,7 W	7,7 VA
5811293440	-	-10% / +10%	-	10,8 VA

Part No.	Switch-on power AC 50 Hz	Pilot	Working pressure min./max.
5811290540	12 VA	Internal	1,5 ... 16 bar
5811290440	15,2 VA	Internal	1,5 ... 16 bar
5811291540	12 VA	Internal	1,5 ... 16 bar
5811291440	15,2 VA	Internal	1,5 ... 16 bar
5811292540	12 VA	External	-0,95 ... 16 bar
5811292440	15,2 VA	External	-0,95 ... 16 bar
5811293540	12 VA	External	-0,95 ... 16 bar
5811293440	15,2 VA	External	-0,95 ... 16 bar

Part No.	Electrical connection Pilot valve	Throttle
5811290540	Plug EN 175301-803, form A	-
5811290440	Plug EN 175301-803, form A	-
5811291540	Plug EN 175301-803, form A	with throttle
5811291440	Plug EN 175301-803, form A	with throttle
5811292540	Plug EN 175301-803, form A	-
5811292440	Plug EN 175301-803, form A	-
5811293540	Plug EN 175301-803, form A	with throttle
5811293440	Plug EN 175301-803, form A	with throttle

Nominal flow  $Q_n$  at 6 bar and  $\Delta p = 1$  bar, MO = Manual override

## Technical information

The min. control pressure must be adhered to, since otherwise faulty switching and valve failure may result!

The pressure dew point must be at least 15 °C under ambient and medium temperature and may not exceed 3 °C .

The oil content of compressed air must remain constant during the life cycle.

Use only the approved oils from AVENTICS. Further information can be found in the "Technical information" document (available in the MediaCentre).

## Technical information

Housing	Aluminum
Seals	Acrylonitrile butadiene rubber

# Dimensions

## Dimensions

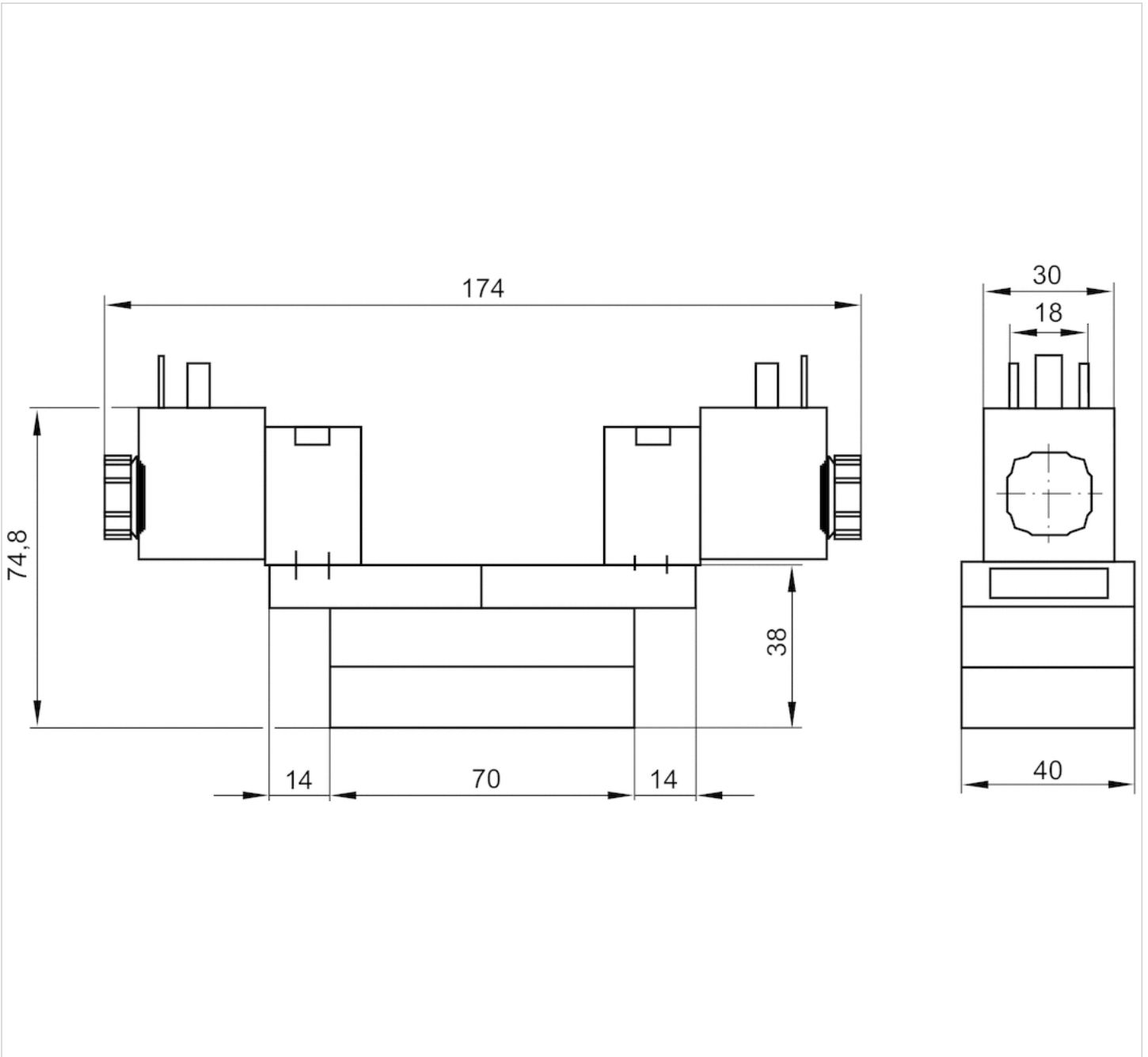

















# 5/2-directional valve, Series 581, size 1

- ISO 5599-1
- ISO 1
- 5/2
- With differential piston
- With air spring return
- $Q_n = 1400$  l/min
- Compressed air connection output Base plate ISO 5599-1
- Electrical connection Plug, EN 175301-803, form A
- Manual override without detent



Type	Spool valve
Sealing principle	Soft sealing
Blocking principle	Single base plate principle
Connection type	Plate connection
Standards	ISO 5599-1, ISO 1
Working pressure min./max.	See table below
Control pressure min./max.	1,3 ... 16 bar
Ambient temperature min./max.	-15 ... 50 °C
Medium temperature min./max.	-15 ... 50 °C
Medium	Compressed air
Max. particle size	50 µm
Oil content of compressed air	0 ... 5 mg/m <sup>3</sup>
Nominal flow $Q_n$	1400 l/min
Flow conductance C	5,2 l/(s*bar)
Protection class with connection	IP65
Duty cycle	100 %
Typ. switch-on time	15 ms
Typ. switch-off time	28 ms
Mounting screw	with hexagon socket
Mounting screw tightening torque	2 Nm
Weight	0,38 kg

## Technical data

Part No.		MO	Operational voltage DC	Operational voltage AC 50 Hz
5811670540			24 V	42 V
5811670440			-	230 V
5811671540			24 V	42 V
5811671440			-	230 V
5811672540			24 V	42 V
5811672440			-	230 V
5811673540			24 V	42 V
5811673440			-	230 V

Part No.	Voltage tolerance DC	Voltage tolerance AC 50 Hz	Power consumption DC	Holding power AC 50 Hz
5811670540	-10% / +10%	-10% / +10%	6,7 W	7,7 VA
5811670440	-	-10% / +10%	-	10,8 VA
5811671540	-10% / +10%	-10% / +10%	6,7 W	7,7 VA
5811671440	-	-10% / +10%	-	10,8 VA
5811672540	-10% / +10%	-10% / +10%	6,7 W	7,7 VA
5811672440	-	-10% / +10%	-	10,8 VA
5811673540	-10% / +10%	-10% / +10%	6,7 W	7,7 VA
5811673440	-	-10% / +10%	-	10,8 VA

Part No.	Switch-on power AC 50 Hz	Pilot	Working pressure min./max.
5811670540	12 VA	Internal	1,3 ... 16 bar
5811670440	15,2 VA	Internal	1,3 ... 16 bar
5811671540	12 VA	Internal	1,3 ... 16 bar
5811671440	15,2 VA	Internal	1,3 ... 16 bar
5811672540	12 VA	External	-0,95 ... 16 bar
5811672440	15,2 VA	External	-0,95 ... 16 bar
5811673540	12 VA	External	-0,95 ... 16 bar
5811673440	15,2 VA	External	-0,95 ... 16 bar

Part No.	Electrical connection Pilot valve	Throttle
5811670540	Plug EN 175301-803, form A	-
5811670440	Plug EN 175301-803, form A	-
5811671540	Plug EN 175301-803, form A	with throttle
5811671440	Plug EN 175301-803, form A	with throttle
5811672540	Plug EN 175301-803, form A	-
5811672440	Plug EN 175301-803, form A	-
5811673540	Plug EN 175301-803, form A	with throttle
5811673440	Plug EN 175301-803, form A	with throttle

Differential piston, signal 14 has priority, The minimum pilot pressure at port 14 is dependent on the pressure in port 1., Nominal flow Qn at 6 bar and  $\Delta p = 1$  bar, MO = Manual override

## Technical information

The min. control pressure must be adhered to, since otherwise faulty switching and valve failure may result!

The pressure dew point must be at least 15 °C under ambient and medium temperature and may not exceed 3 °C .

The oil content of compressed air must remain constant during the life cycle.

Use only the approved oils from AVENTICS. Further information can be found in the "Technical information" document (available in the MediaCentre).

## Technical information

Housing	Aluminum
Seals	Acrylonitrile butadiene rubber

## Dimensions

### Dimensions

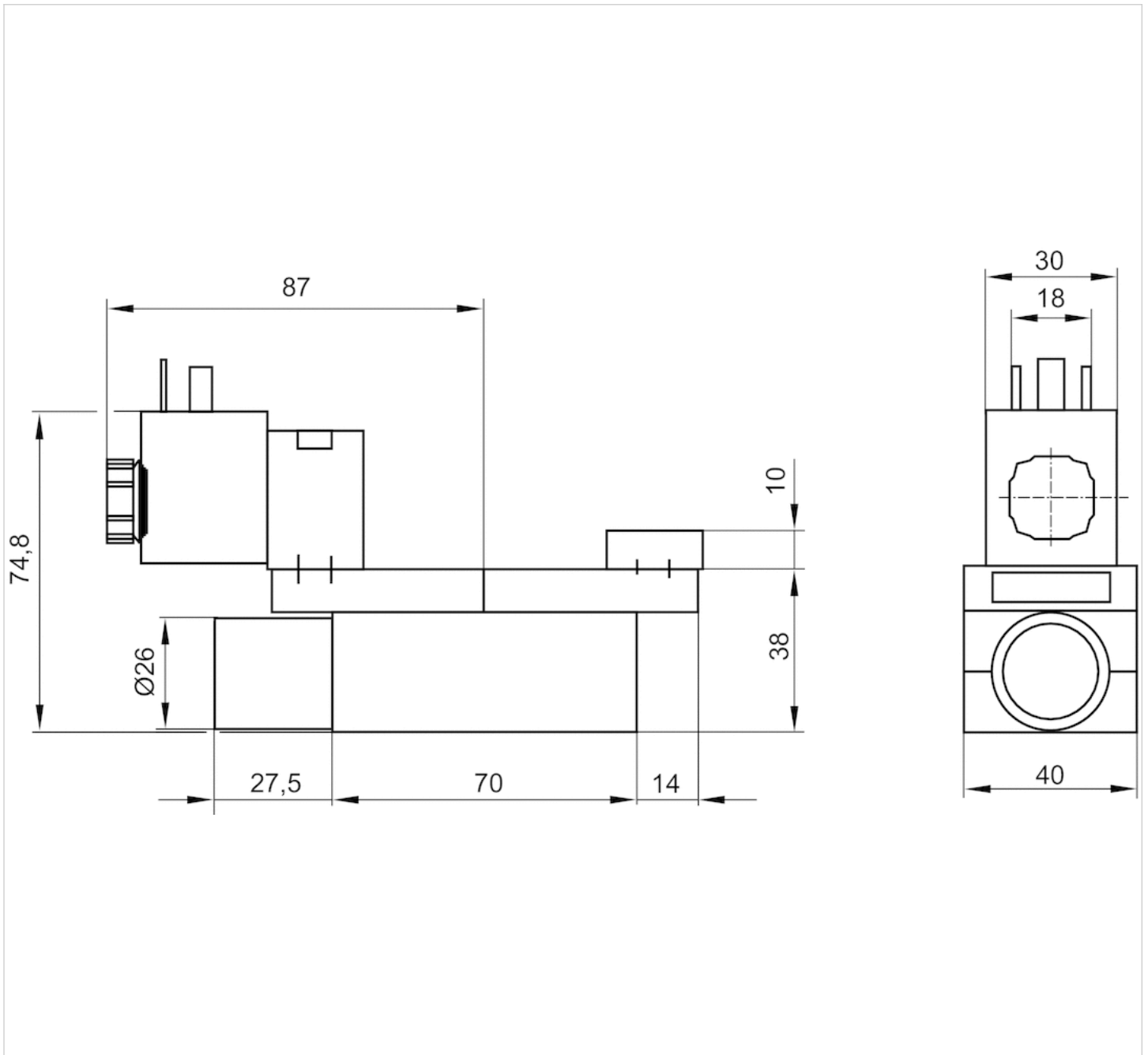



# 5/2-directional valve, Series 581, size 1

- ISO 5599-1
- ISO 1
- 5/2
- With spring return
- single solenoid
- $Q_n = 1400 \text{ l/min}$
- Compressed air connection output Base plate ISO 5599-1
- Electrical connection Plug, EN 175301-803, form A
- Manual override with detent, without detent



Type	Spool valve
Sealing principle	Soft sealing
Blocking principle	Single base plate principle
Connection type	Plate connection
Standards	ISO 5599-1, ISO 1
Working pressure min./max.	See table below
Control pressure min./max.	3 ... 10 bar
Ambient temperature min./max.	-15 ... 50 °C
Medium temperature min./max.	-15 ... 50 °C
Medium	Compressed air
Max. particle size	50 µm
Oil content of compressed air	0 ... 5 mg/m <sup>3</sup>
Nominal flow $Q_n$	1400 l/min
Flow conductance C	5,2 l/(s*bar)
Protection class with connection	IP65
Compatibility index	14
Duty cycle	100 %
Typ. switch-on time	15 ms
Typ. switch-off time	28 ms
Mounting screw	with hexagon socket
Mounting screw tightening torque	2 Nm
Weight	0,35 kg



## Technical information

The min. control pressure must be adhered to, since otherwise faulty switching and valve failure may result!

The pressure dew point must be at least 15 °C under ambient and medium temperature and may not exceed 3 °C .

The oil content of compressed air must remain constant during the life cycle.

Use only the approved oils from AVENTICS. Further information can be found in the "Technical information" document (available in the MediaCentre).

## Technical information

Housing	Aluminum
Seals	Acrylonitrile butadiene rubber

## Dimensions

### Dimensions

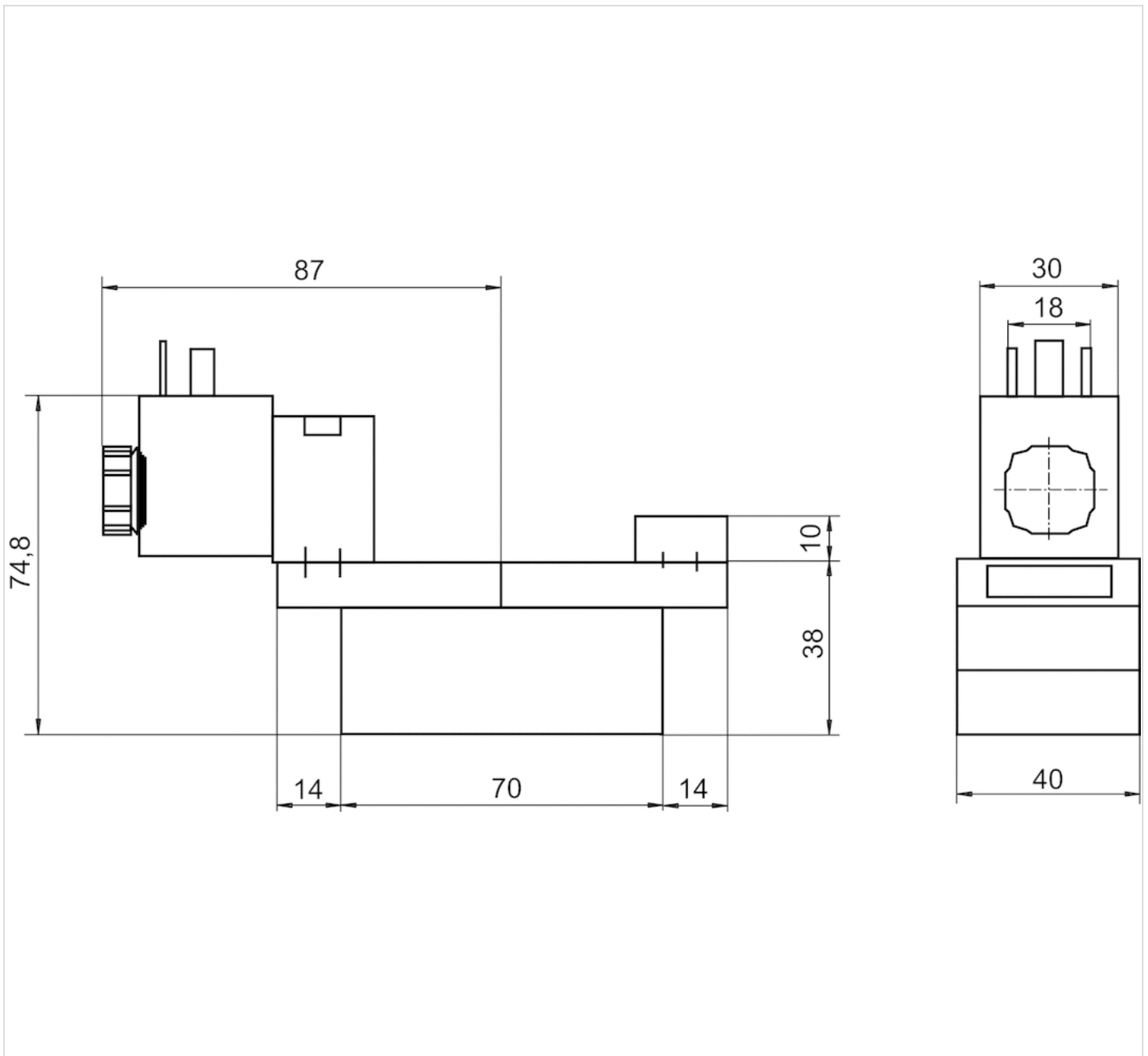









# 5/2-directional valve, Series 581, size 1

- ISO 5599-1
- ISO 1
- 5/2
- double solenoid
- Qn = 1400 l/min
- Compressed air connection output Base plate ISO 5599-1
- Electrical connection Plug, EN 175301-803, form A
- Manual override with detent, without detent



Type	Spool valve
Sealing principle	Soft sealing
Blocking principle	Single base plate principle
Connection type	Plate connection
Standards	ISO 5599-1, ISO 1
Working pressure min./max.	See table below
Control pressure min./max.	1,5 ... 10 bar
Ambient temperature min./max.	-15 ... 50 °C
Medium temperature min./max.	-15 ... 50 °C
Medium	Compressed air
Max. particle size	50 µm
Oil content of compressed air	0 ... 5 mg/m <sup>3</sup>
Nominal flow Qn	1400 l/min
Flow conductance C	5,2 l/(s*bar)
Protection class with connection	IP65
Compatibility index	14
Duty cycle	100 %
Typ. switch-on time	13 ms
Typ. switch-off time	13 ms
Mounting screw	with hexagon socket
Mounting screw tightening torque	2 Nm
Weight	0,5 kg

## Technical data

Part No.		MO	Operational voltage DC	Operational voltage AC 50 Hz
5811290650		TT-R-T-R	24 V	-
5811290450			-	230 V
5811291650		TT-R-T-R	24 V	-
5811291450			-	230 V
5811292650		TT-R-T-R	24 V	-
5811292450			-	230 V
5811293650		TT-R-T-R	24 V	-
5811293450			-	230 V

Part No.	Voltage tolerance DC	Voltage tolerance AC 50 Hz	Power consumption DC	Holding power AC 50 Hz
5811290650	-10% / +10%	-	2 W	-
5811290450	-	-10% / +10%	-	4,8 VA
5811291650	-10% / +10%	-	2 W	-
5811291450	-	-10% / +10%	-	4,8 VA
5811292650	-10% / +10%	-	2 W	-
5811292450	-	-10% / +10%	-	4,8 VA
5811293650	-10% / +10%	-	2 W	-
5811293450	-	-10% / +10%	-	4,8 VA

Part No.	Switch-on power AC 50 Hz	Pilot	Working pressure min./max.	Compatibility index
5811290650	-	Internal	1,5 ... 10 bar	14
5811290450	7 VA	Internal	1,5 ... 10 bar	14
5811291650	-	Internal	1,5 ... 10 bar	14
5811291450	7 VA	Internal	1,5 ... 10 bar	14
5811292650	-	External	-0,95 ... 10 bar	14
5811292450	7 VA	External	-0,95 ... 10 bar	14
5811293650	-	External	-0,95 ... 10 bar	14
5811293450	7 VA	External	-0,95 ... 10 bar	14

Part No.	Electrical connection Pilot valve	Throttle
5811290650	Plug EN 175301-803, form A	-
5811290450	Plug EN 175301-803, form A	-
5811291650	Plug EN 175301-803, form A	with throttle
5811291450	Plug EN 175301-803, form A	with throttle
5811292650	Plug EN 175301-803, form A	-
5811292450	Plug EN 175301-803, form A	-
5811293650	Plug EN 175301-803, form A	with throttle
5811293450	Plug EN 175301-803, form A	with throttle

Nominal flow  $Q_n$  at 6 bar and  $\Delta p = 1$  bar, MO = Manual override, An operating pressure of up to 16 bar is possible in the version with manual override without detent.

## Technical information

The min. control pressure must be adhered to, since otherwise faulty switching and valve failure may result!

The pressure dew point must be at least 15 °C under ambient and medium temperature and may not exceed 3 °C .

The oil content of compressed air must remain constant during the life cycle.

Use only the approved oils from AVENTICS. Further information can be found in the "Technical information" document (available in the MediaCentre).

## Technical information

Housing	Aluminum
Seals	Acrylonitrile butadiene rubber

## Dimensions

### Dimensions

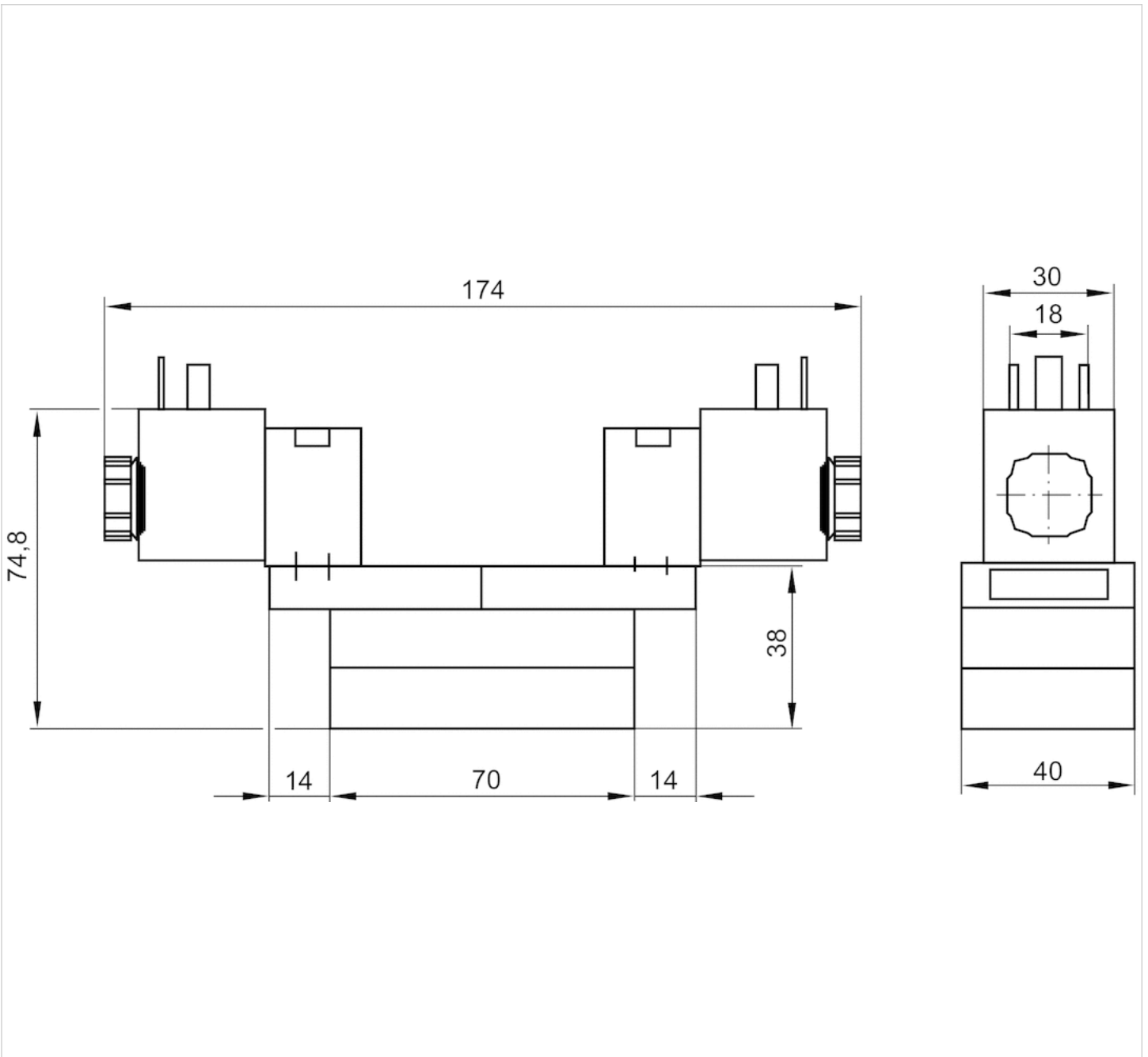

# 5/2-directional valve, Series 581, size 1

- ISO 5599-1
- ISO 1
- 5/2
- With differential piston
- With air spring return
- $Q_n = 1400 \text{ l/min}$
- Compressed air connection output Base plate ISO 5599-1
- Electrical connection Plug, EN 175301-803, form A
- Manual override with detent, without detent



Type	Spool valve
Sealing principle	Soft sealing
Blocking principle	Single base plate principle
Connection type	Plate connection
Standards	ISO 5599-1, ISO 1
Working pressure min./max.	See table below
Control pressure min./max.	1,3 ... 10 bar
Ambient temperature min./max.	-15 ... 50 °C
Medium temperature min./max.	-15 ... 50 °C
Medium	Compressed air
Max. particle size	50 µm
Oil content of compressed air	0 ... 5 mg/m <sup>3</sup>
Nominal flow $Q_n$	1400 l/min
Flow conductance C	5,2 l/(s*bar)
Protection class with connection	IP65
Compatibility index	14
Duty cycle	100 %
Typ. switch-on time	15 ms
Typ. switch-off time	28 ms
Mounting screw	with hexagon socket
Mounting screw tightening torque	2 Nm
Weight	0,38 kg





## Technical information

The min. control pressure must be adhered to, since otherwise faulty switching and valve failure may result!

The pressure dew point must be at least 15 °C under ambient and medium temperature and may not exceed 3 °C .

The oil content of compressed air must remain constant during the life cycle.

Use only the approved oils from AVENTICS. Further information can be found in the "Technical information" document (available in the MediaCentre).

## Technical information

Housing	Aluminum
Seals	Acrylonitrile butadiene rubber

# Dimensions

## Dimensions

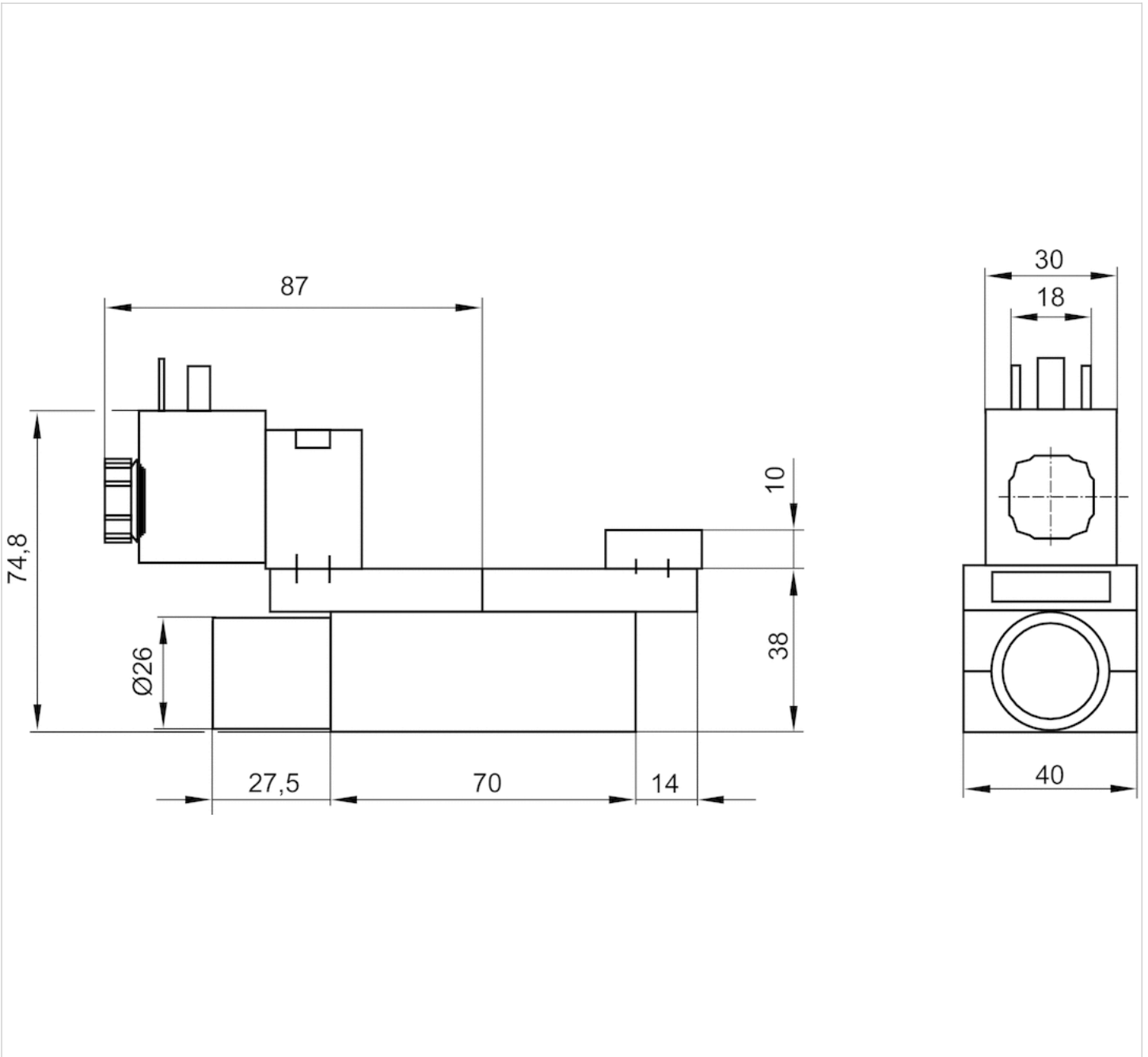









# 5/2-directional valve, Series 581, size 1

- ISO 5599-1
- ISO 1
- 5/2
- double solenoid
- Qn = 1400 l/min
- Compressed air connection output Base plate ISO 5599-1
- Electrical connection Plug, EN 175301-803, form A
- Manual override without



Type	Spool valve
Sealing principle	Soft sealing
Blocking principle	Single base plate principle
Connection type	Plate connection
Standards	ISO 5599-1, ISO 1
Working pressure min./max.	See table below
Control pressure min./max.	1,5 ... 16 bar
Ambient temperature min./max.	-15 ... 50 °C
Medium temperature min./max.	-15 ... 50 °C
Medium	Compressed air
Max. particle size	50 µm
Oil content of compressed air	0 ... 5 mg/m <sup>3</sup>
Nominal flow Qn	1400 l/min
Flow conductance C	5,2 l/(s*bar)
Protection class with connection	IP65
Duty cycle	100 %
Typ. switch-on time	13 ms
Typ. switch-off time	13 ms
Mounting screw	with hexagon socket
Mounting screw tightening torque	2 Nm
Weight	0,5 kg

## Technical data

Part No.		Operational voltage DC	Operational voltage AC 50 Hz	Voltage tolerance DC
5811290530		24 V	-	-10% / +10%
5811290430		-	230 V	-
5811291530		24 V	-	-10% / +10%
5811291430		-	230 V	-
5811292530		24 V	-	-10% / +10%
5811292430		-	230 V	-
5811293530		24 V	-	-10% / +10%
5811293430		-	230 V	-

Part No.	Voltage tolerance AC 50 Hz	Power consumption DC	Holding power AC 50 Hz	Switch-on power AC 50 Hz
5811290530	-	6,7 W	-	-

Part No.	Voltage tolerance AC 50 Hz	Power consumption DC	Holding power AC 50 Hz	Switch-on power AC 50 Hz
5811290430	-10% / +10%	-	10,8 VA	15,2 VA
5811291530	-	6,7 W	-	-
5811291430	-10% / +10%	-	10,8 VA	15,2 VA
5811292530	-	6,7 W	-	-
5811292430	-10% / +10%	-	10,8 VA	15,2 VA
5811293530	-	6,7 W	-	-
5811293430	-10% / +10%	-	10,8 VA	15,2 VA

Part No.	Pilot	Working pressure min./max.	Electrical connection Pilot valve	Throttle
5811290530	Internal	1,5 ... 16 bar	Plug EN 175301-803, form A	-
5811290430	Internal	1,5 ... 16 bar	Plug EN 175301-803, form A	-
5811291530	Internal	1,5 ... 16 bar	Plug EN 175301-803, form A	with throttle
5811291430	Internal	1,5 ... 16 bar	Plug EN 175301-803, form A	with throttle
5811292530	External	-0,95 ... 16 bar	Plug EN 175301-803, form A	-
5811292430	External	-0,95 ... 16 bar	Plug EN 175301-803, form A	-
5811293530	External	-0,95 ... 16 bar	Plug EN 175301-803, form A	with throttle
5811293430	External	-0,95 ... 16 bar	Plug EN 175301-803, form A	with throttle

Nominal flow  $Q_n$  at 6 bar and  $\Delta p = 1$  bar

## Technical information

The min. control pressure must be adhered to, since otherwise faulty switching and valve failure may result!

The pressure dew point must be at least 15 °C under ambient and medium temperature and may not exceed 3 °C .

The oil content of compressed air must remain constant during the life cycle.

Use only the approved oils from AVENTICS. Further information can be found in the "Technical information" document (available in the MediaCentre).

## Technical information

Housing	Aluminum
Seals	Acrylonitrile butadiene rubber

## Dimensions

### Dimensions

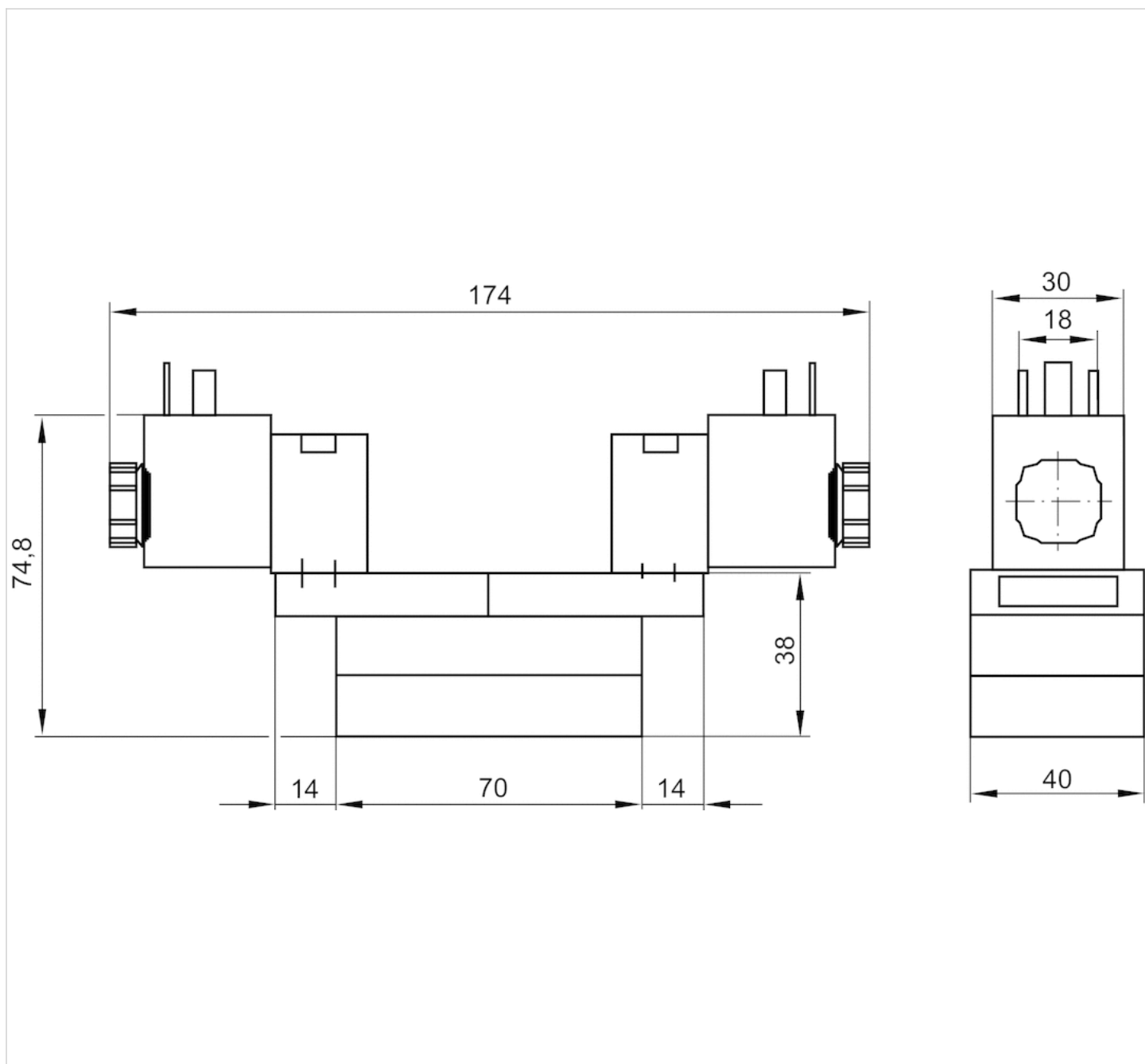









# 5/2-directional valve, Series 581, size 1

- ISO 5599-1
- ISO 1
- 5/2
- With differential piston
- With air spring return
- $Q_n = 1400$  l/min
- Compressed air connection output Base plate ISO 5599-1
- Electrical connection Plug, EN 175301-803, form A
- Manual override without



Type	Spool valve
Sealing principle	Soft sealing
Blocking principle	Single base plate principle
Connection type	Plate connection
Standards	ISO 5599-1, ISO 1
Working pressure min./max.	See table below
Control pressure min./max.	1,3 ... 16 bar
Ambient temperature min./max.	-15 ... 50 °C
Medium temperature min./max.	-15 ... 50 °C
Medium	Compressed air
Max. particle size	50 µm
Oil content of compressed air	0 ... 5 mg/m <sup>3</sup>
Nominal flow $Q_n$	1400 l/min
Flow conductance C	5,2 l/(s*bar)
Protection class with connection	IP65
Duty cycle	100 %
Typ. switch-on time	15 ms
Typ. switch-off time	28 ms
Mounting screw	with hexagon socket
Mounting screw tightening torque	2 Nm
Weight	0,38 kg

## Technical data

Part No.		Operational voltage DC	Operational voltage AC 50 Hz	Voltage tolerance DC
5811670530		24 V	-	-10% / +10%
5811670430		-	230 V	-
5811671530		24 V	-	-10% / +10%
5811671430		-	230 V	-
5811672530		24 V	-	-10% / +10%
5811672430		-	230 V	-
5811673530		24 V	-	-10% / +10%
5811673430		-	230 V	-

Part No.	Voltage tolerance AC 50 Hz	Power consumption DC	Holding power AC 50 Hz	Switch-on power AC 50 Hz
5811670530	-	6,7 W	-	-
5811670430	-10% / +10%	-	10,8 VA	15,2 VA
5811671530	-	6,7 W	-	-
5811671430	-10% / +10%	-	10,8 VA	15,2 VA
5811672530	-	6,7 W	-	-
5811672430	-10% / +10%	-	10,8 VA	15,2 VA
5811673530	-	6,7 W	-	-
5811673430	-10% / +10%	-	10,8 VA	15,2 VA

Part No.	Pilot	Working pressure min./max.	Electrical connection Pilot valve	Throttle
5811670530	Internal	1,3 ... 16 bar	Plug EN 175301-803, form A	-
5811670430	Internal	1,3 ... 16 bar	Plug EN 175301-803, form A	-
5811671530	Internal	1,3 ... 16 bar	Plug EN 175301-803, form A	with throttle
5811671430	Internal	1,3 ... 16 bar	Plug EN 175301-803, form A	with throttle
5811672530	External	-0,95 ... 16 bar	Plug EN 175301-803, form A	-
5811672430	External	-0,95 ... 16 bar	Plug EN 175301-803, form A	-
5811673530	External	-0,95 ... 16 bar	Plug EN 175301-803, form A	with throttle
5811673430	External	-0,95 ... 16 bar	Plug EN 175301-803, form A	with throttle

Differential piston, signal 14 has priority, The minimum pilot pressure at port 14 is dependent on the pressure in port 1., Nominal flow Qn at 6 bar and  $\Delta p = 1$  bar

## Technical information

The min. control pressure must be adhered to, since otherwise faulty switching and valve failure may result!

The pressure dew point must be at least 15 °C under ambient and medium temperature and may not exceed 3 °C .

The oil content of compressed air must remain constant during the life cycle.

Use only the approved oils from AVENTICS. Further information can be found in the "Technical information" document (available in the MediaCentre).

## Technical information

Housing	Aluminum
Seals	Acrylonitrile butadiene rubber



## Dimensions

## Dimensions

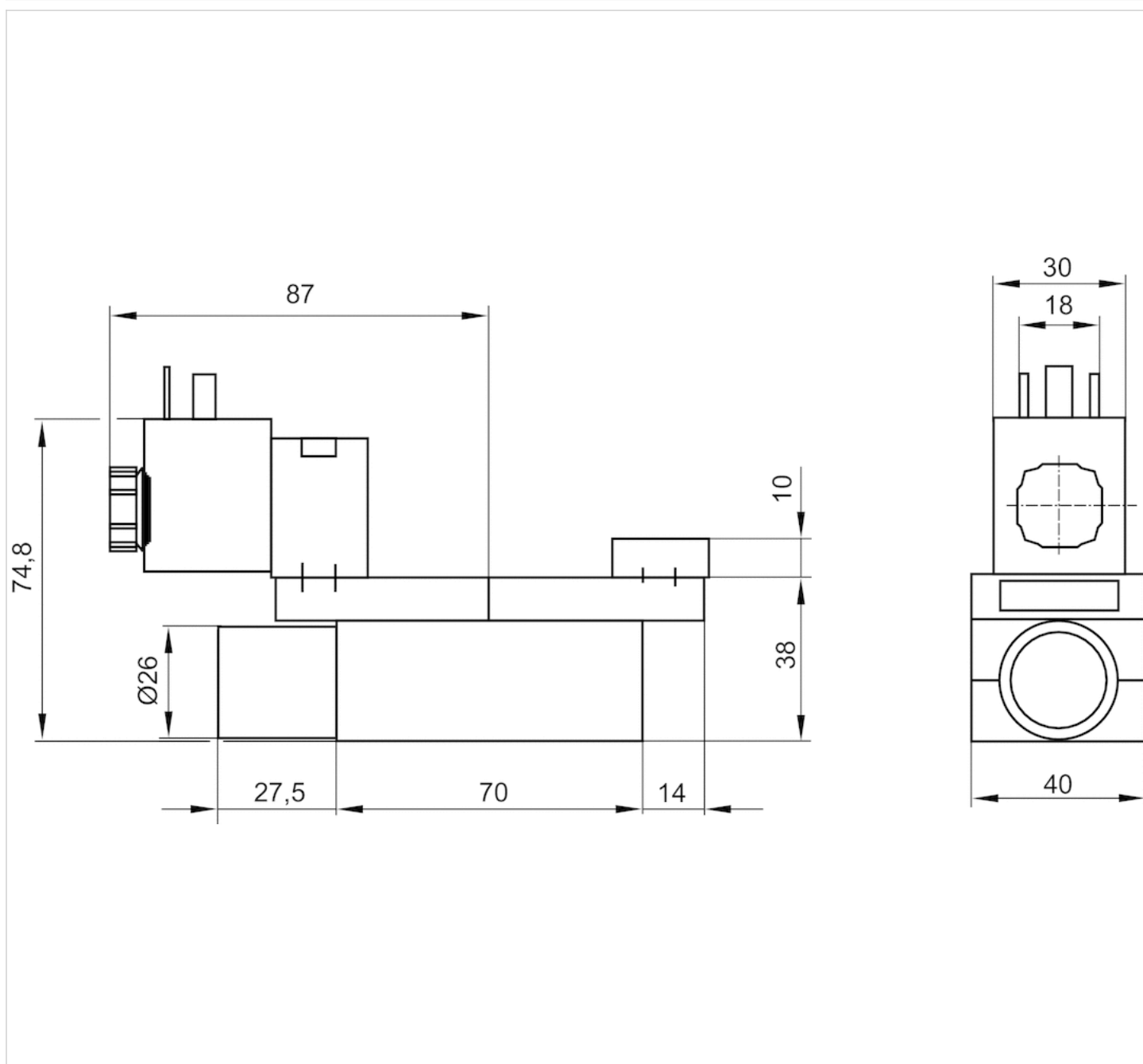









# 5/2-directional valve, Series 581, size 1

- ISO 5599-1
- ISO 1
- 5/2
- With spring return
- single solenoid
- $Q_n = 1400 \text{ l/min}$
- Compressed air connection output Base plate ISO 5599-1
- Electrical connection Plug, EN 175301-803, form A
- Manual override without



Type	Spool valve
Sealing principle	Soft sealing
Blocking principle	Single base plate principle
Connection type	Plate connection
Standards	ISO 5599-1, ISO 1
Working pressure min./max.	See table below
Control pressure min./max.	3 ... 16 bar
Ambient temperature min./max.	-15 ... 50 °C
Medium temperature min./max.	-15 ... 50 °C
Medium	Compressed air
Max. particle size	50 µm
Oil content of compressed air	0 ... 5 mg/m <sup>3</sup>
Nominal flow $Q_n$	1400 l/min
Flow conductance C	5,2 l/(s*bar)
Protection class with connection	IP65
Duty cycle	100 %
Typ. switch-on time	15 ms
Typ. switch-off time	28 ms
Mounting screw	with hexagon socket
Mounting screw tightening torque	2 Nm
Weight	0,35 kg

## Technical data

Part No.		Operational voltage DC	Operational voltage AC 50 Hz	Voltage tolerance DC
5811170530		24 V	-	-10% / +10%
5811170430		-	230 V	-
5811171530		24 V	-	-10% / +10%
5811171430		-	230 V	-
5811172530		24 V	-	-10% / +10%
5811172430		-	230 V	-
5811173530		24 V	-	-10% / +10%
5811173430		-	230 V	-

Part No.	Voltage tolerance AC 50 Hz	Power consumption DC	Holding power AC 50 Hz	Switch-on power AC 50 Hz
5811170530	-	6,7 W	-	-
5811170430	-10% / +10%	-	10,8 VA	15,2 VA
5811171530	-	6,7 W	-	-
5811171430	-10% / +10%	-	10,8 VA	15,2 VA
5811172530	-	6,7 W	-	-
5811172430	-10% / +10%	-	10,8 VA	15,2 VA
5811173530	-	6,7 W	-	-
5811173430	-10% / +10%	-	10,8 VA	15,2 VA

Part No.	Pilot	Working pressure min./max.	Electrical connection Pilot valve	Throttle
5811170530	Internal	3 ... 16 bar	Plug EN 175301-803, form A	-
5811170430	Internal	3 ... 16 bar	Plug EN 175301-803, form A	-
5811171530	Internal	3 ... 16 bar	Plug EN 175301-803, form A	with throttle
5811171430	Internal	3 ... 16 bar	Plug EN 175301-803, form A	with throttle
5811172530	External	-0,95 ... 16 bar	Plug EN 175301-803, form A	-
5811172430	External	-0,95 ... 16 bar	Plug EN 175301-803, form A	-
5811173530	External	-0,95 ... 16 bar	Plug EN 175301-803, form A	with throttle
5811173430	External	-0,95 ... 16 bar	Plug EN 175301-803, form A	with throttle

Nominal flow  $Q_n$  at 6 bar and  $\Delta p = 1$  bar

## Technical information

The min. control pressure must be adhered to, since otherwise faulty switching and valve failure may result!

The pressure dew point must be at least 15 °C under ambient and medium temperature and may not exceed 3 °C .

The oil content of compressed air must remain constant during the life cycle.

Use only the approved oils from AVENTICS. Further information can be found in the "Technical information" document (available in the MediaCentre).

## Technical information

Housing	Aluminum
Seals	Acrylonitrile butadiene rubber

## Dimensions

### Dimensions

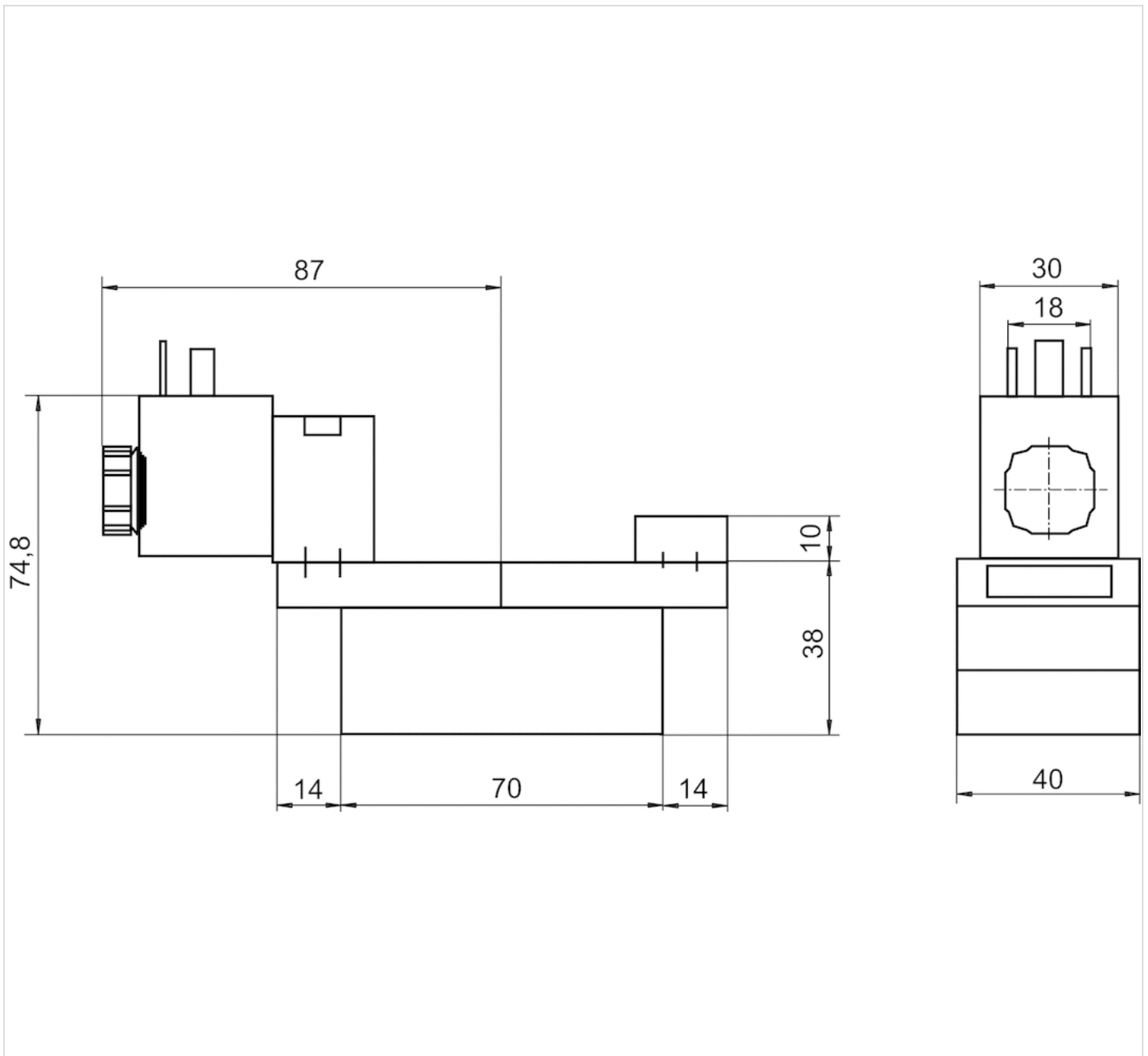









# 5/2-directional valve, Series 581, size 1

- ISO 5599-1
- ISO 1
- 5/2
- double solenoid
- $Q_n = 1400$  l/min
- Compressed air connection output Base plate ISO 5599-1
- Electrical connection Plug, EN 175301-803, form A
- Manual override without detent



Type	Spool valve
Sealing principle	Soft sealing
Blocking principle	Single base plate principle
Connection type	Plate connection
Standards	ISO 5599-1, ISO 1
Working pressure min./max.	See table below
Control pressure min./max.	1,5 ... 10 bar
Ambient temperature min./max.	-15 ... 50 °C
Medium temperature min./max.	-15 ... 50 °C
Medium	Compressed air
Max. particle size	50 µm
Oil content of compressed air	0 ... 5 mg/m <sup>3</sup>
Nominal flow $Q_n$	1400 l/min
Flow conductance C	5,2 l/(s*bar)
Protection class with connection	IP65
Duty cycle	100 %
Typ. switch-on time	13 ms
Typ. switch-off time	13 ms
Mounting screw	with hexagon socket
Mounting screw tightening torque	2 Nm
Weight	0,58 kg

## Technical data

Part No.		MO	Operational voltage DC	Voltage tolerance DC
5811290190			24 V	-10% / +10%
5811291190			24 V	-10% / +10%
5811292190			24 V	-10% / +10%
5811293190			24 V	-10% / +10%

Part No.	Power consumption DC	Pilot	Working pressure min./max.
5811290190	6 W	Internal	1,5 ... 10 bar
5811291190	6 W	Internal	1,5 ... 10 bar
5811292190	6 W	External	-0,95 ... 10 bar
5811293190	6 W	External	-0,95 ... 10 bar

Part No.	Electrical connection Pilot valve	Throttle
5811290190	Plug EN 175301-803, form A	-
5811291190	Plug EN 175301-803, form A	with throttle
5811292190	Plug EN 175301-803, form A	-
5811293190	Plug EN 175301-803, form A	with throttle

Nominal flow  $Q_n$  at 6 bar and  $\Delta p = 1$  bar, MO = Manual override

## Technical information

The min. control pressure must be adhered to, since otherwise faulty switching and valve failure may result!

The pressure dew point must be at least 15 °C under ambient and medium temperature and may not exceed 3 °C .

The oil content of compressed air must remain constant during the life cycle.

Use only the approved oils from AVENTICS. Further information can be found in the "Technical information" document (available in the MediaCentre).

## Technical information

Housing	Aluminum
Seals	Acrylonitrile butadiene rubber

# Dimensions

## Dimensions

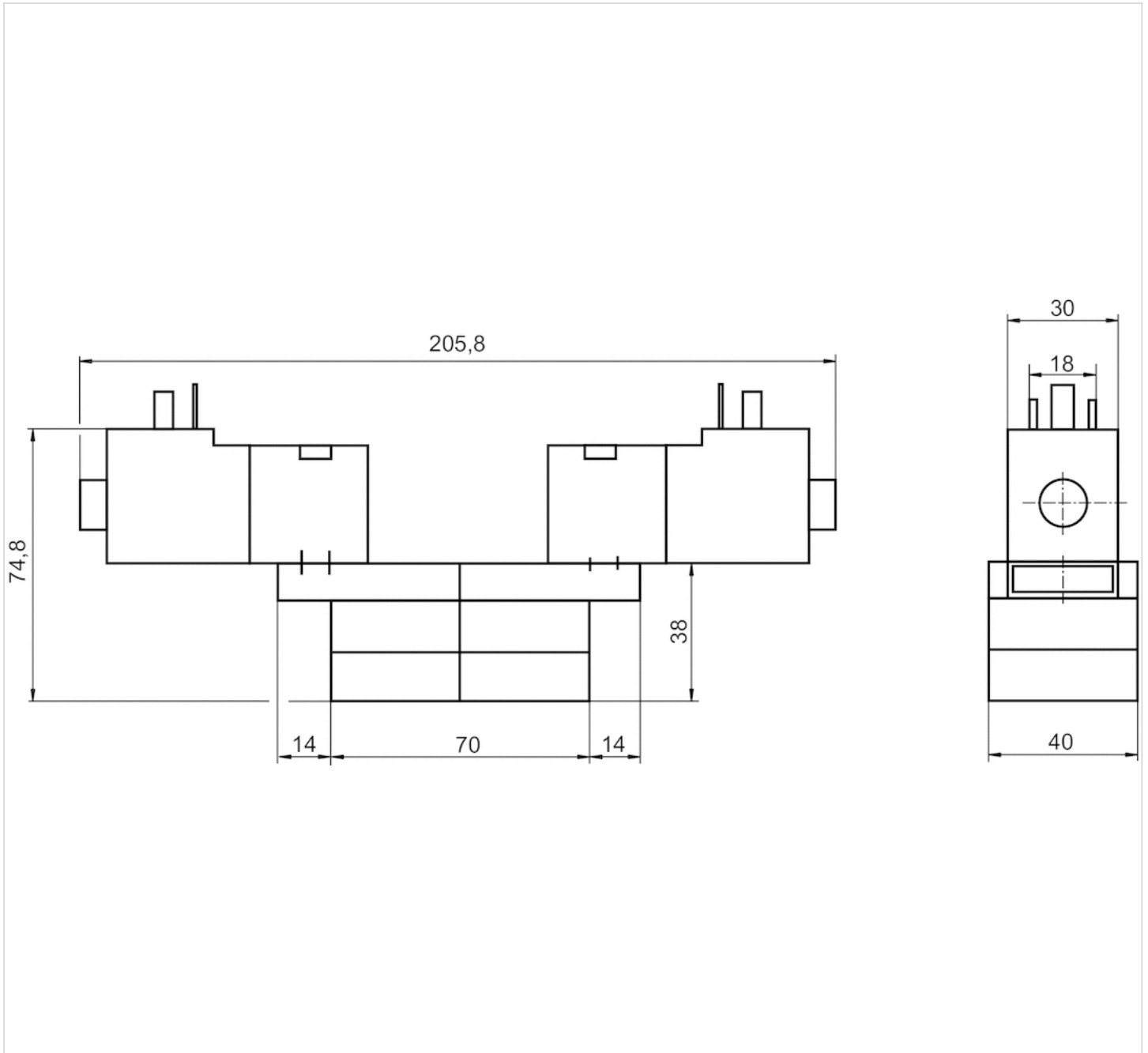









# 5/2-directional valve, Series 581, size 1

- ISO 5599-1
- ISO 1
- 5/2
- With differential piston
- With spring return
- $Q_n = 1400$  l/min
- Compressed air connection output Base plate ISO 5599-1
- Electrical connection Plug, EN 175301-803, form A
- Manual override without detent



Type	Spool valve
Sealing principle	Soft sealing
Blocking principle	Single base plate principle
Connection type	Plate connection
Standards	ISO 5599-1, ISO 1
Working pressure min./max.	See table below
Control pressure min./max.	1,3 ... 10 bar
Ambient temperature min./max.	-15 ... 50 °C
Medium temperature min./max.	-15 ... 50 °C
Medium	Compressed air
Max. particle size	50 µm
Oil content of compressed air	0 ... 5 mg/m <sup>3</sup>
Nominal flow $Q_n$	1400 l/min
Flow conductance C	5,2 l/(s*bar)
Protection class with connection	IP65
Duty cycle	100 %
Typ. switch-on time	15 ms
Typ. switch-off time	28 ms
Mounting screw	with hexagon socket
Mounting screw tightening torque	2 Nm
Weight	0,42 kg

## Technical data

Part No.		MO	Operational voltage DC	Voltage tolerance DC
5811670190			24 V	-10% / +10%
5811671190			24 V	-10% / +10%
5811672190			24 V	-10% / +10%
5811673190			24 V	-10% / +10%

Part No.	Power consumption DC	Pilot	Working pressure min./max.
5811670190	6 W	Internal	1,3 ... 10 bar
5811671190	6 W	Internal	1,3 ... 10 bar
5811672190	6 W	External	-0,95 ... 10 bar
5811673190	6 W	External	-0,95 ... 10 bar



Part No.	Electrical connection Pilot valve	Throttle
5811670190	Plug EN 175301-803, form A	-
5811671190	Plug EN 175301-803, form A	with throttle
5811672190	Plug EN 175301-803, form A	-
5811673190	Plug EN 175301-803, form A	with throttle

Differential piston, signal 14 has priority, The minimum pilot pressure at port 14 is dependent on the pressure in port 1., Nominal flow Qn at 6 bar and  $\Delta p = 1$  bar, MO = Manual override

## Technical information

The min. control pressure must be adhered to, since otherwise faulty switching and valve failure may result!  
 The pressure dew point must be at least 15 °C under ambient and medium temperature and may not exceed 3 °C .  
 The oil content of compressed air must remain constant during the life cycle.  
 Use only the approved oils from AVENTICS. Further information can be found in the "Technical information" document (available in the MediaCentre).

## Technical information

Housing	Aluminum
Seals	Acrylonitrile butadiene rubber

## Dimensions

### Dimensions

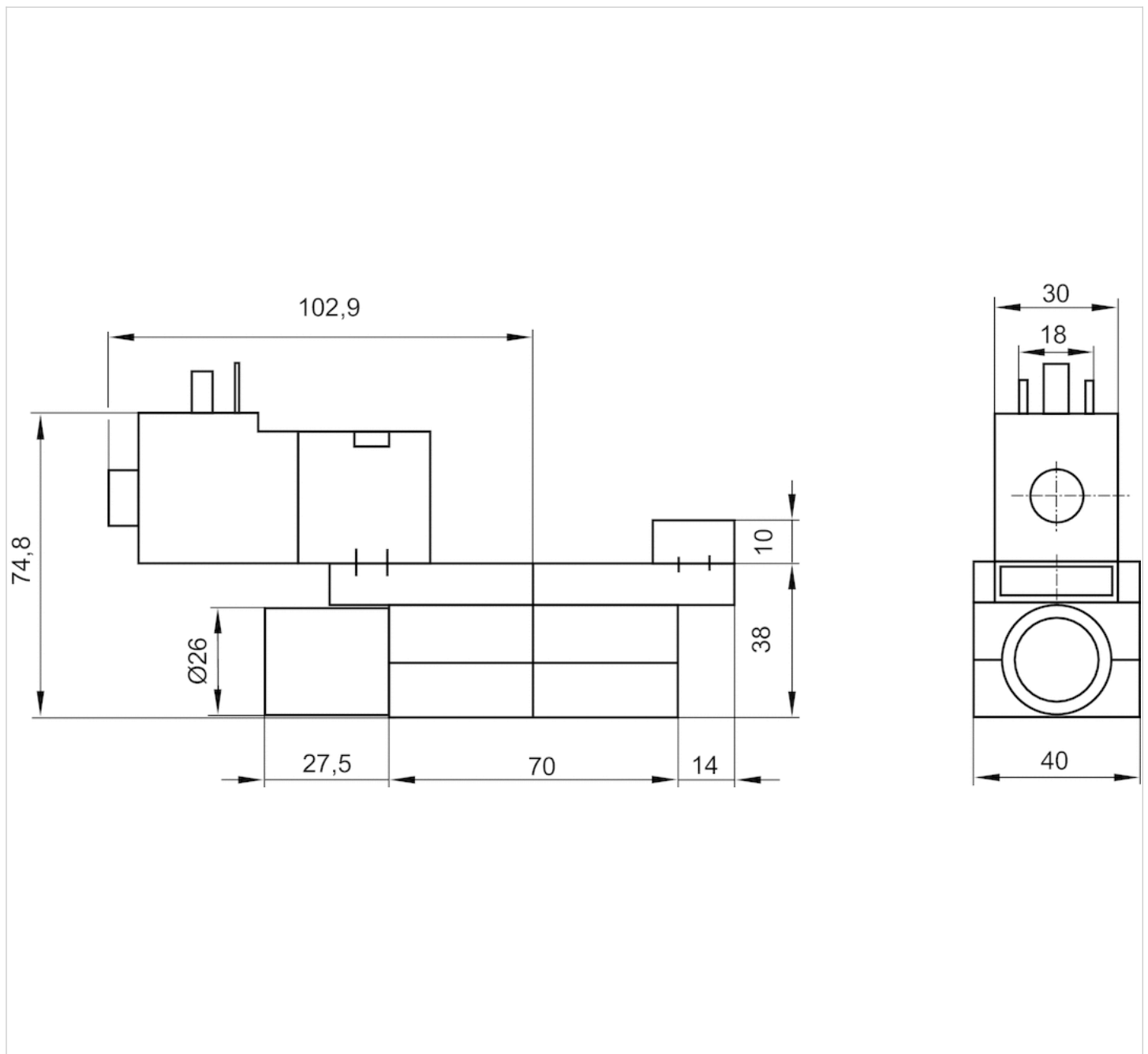









# 5/2-directional valve, Series 581, size 1

- ISO 5599-1
- ISO 1
- 5/2
- With spring return
- double solenoid
- $Q_n = 1400 \text{ l/min}$
- Compressed air connection output Base plate ISO 5599-1
- Electrical connection Plug, EN 175301-803, form A
- Manual override without detent



Type	Spool valve
Sealing principle	Soft sealing
Blocking principle	Single base plate principle
Connection type	Plate connection
Standards	ISO 5599-1, ISO 1
Working pressure min./max.	See table below
Control pressure min./max.	3 ... 10 bar
Ambient temperature min./max.	-15 ... 50 °C
Medium temperature min./max.	-15 ... 50 °C
Medium	Compressed air
Max. particle size	50 µm
Oil content of compressed air	0 ... 5 mg/m <sup>3</sup>
Nominal flow $Q_n$	1400 l/min
Flow conductance C	5,2 l/(s*bar)
Protection class with connection	IP65
Duty cycle	100 %
Typ. switch-on time	15 ms
Typ. switch-off time	28 ms
Mounting screw	with hexagon socket
Mounting screw tightening torque	2 Nm
Weight	0,39 kg

## Technical data

Part No.		MO	Operational voltage DC	Voltage tolerance DC
5811170190			24 V	-10% / +10%
5811171190			24 V	-10% / +10%
5811172190			24 V	-10% / +10%
5811173190			24 V	-10% / +10%

Part No.	Power consumption DC	Pilot	Working pressure min./max.
5811170190	6 W	Internal	3 ... 10 bar
5811171190	6 W	Internal	3 ... 10 bar
5811172190	6 W	External	-0,95 ... 10 bar
5811173190	6 W	External	-0,95 ... 10 bar

Part No.	Electrical connection Pilot valve	Throttle
5811170190	Plug EN 175301-803, form A	-
5811171190	Plug EN 175301-803, form A	with throttle
5811172190	Plug EN 175301-803, form A	-
5811173190	Plug EN 175301-803, form A	with throttle

Nominal flow Qn at 6 bar and  $\Delta p = 1$  bar, MO = Manual override

## Technical information

The min. control pressure must be adhered to, since otherwise faulty switching and valve failure may result!  
 The pressure dew point must be at least 15 °C under ambient and medium temperature and may not exceed 3 °C .  
 The oil content of compressed air must remain constant during the life cycle.  
 Use only the approved oils from AVENTICS. Further information can be found in the “Technical information” document (available in the MediaCentre).

## Technical information

Housing	Aluminum
Seals	Acrylonitrile butadiene rubber

## Dimensions

### Dimensions

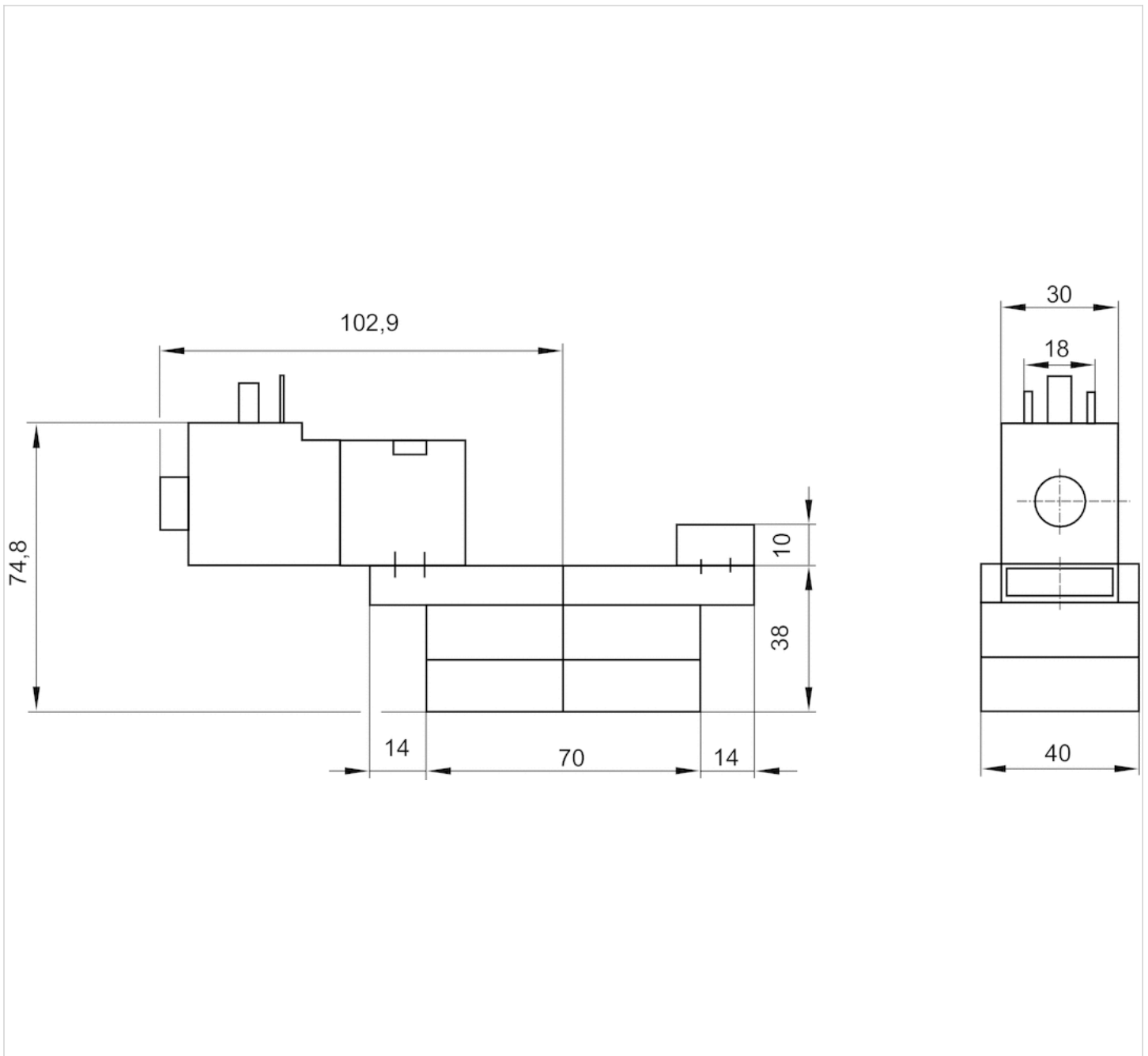











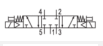

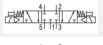



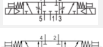

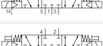



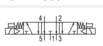

# 5/3-directional valve, Series 581, size 1

- ISO 5599-1
- ISO 1
- 5/3
- closed center exhausted center pressurized center
- Qn = 1100 l/min
- Compressed air connection output Base plate ISO 5599-1
- Electrical connection Plug, EN 175301-803, form A
- Manual override without detent



Type	Spool valve
Sealing principle	Soft sealing
Blocking principle	Single base plate principle
Connection type	Plate connection
Standards	ISO 5599-1, ISO 1
Working pressure min./max.	See table below
Control pressure min./max.	3 ... 16 bar
Ambient temperature min./max.	-15 ... 50 °C
Medium temperature min./max.	-15 ... 50 °C
Medium	Compressed air
Max. particle size	50 µm
Oil content of compressed air	0 ... 5 mg/m <sup>3</sup>
Nominal flow Qn	1100 l/min
Flow conductance C	4,3 l/(s*bar)
Protection class with connection	IP65
Duty cycle	100 %
Typ. switch-on time	14 ms
Typ. switch-off time	28 ms
Mounting screw	with hexagon socket
Mounting screw tightening torque	2 Nm
Weight	0,5 kg

## Technical data

Part No.		MO		Operational voltage DC
5811490540			closed center	24 V
5811490440			closed center	-
5811491540			closed center	24 V
5811491440			closed center	-
5811492540			closed center	24 V
5811492440			closed center	-
5811493540			closed center	24 V
5811493440			closed center	-
5811590540			exhausted center	24 V
5811590440			exhausted center	-
5811591540			exhausted center	24 V
5811591440			exhausted center	-

Part No.		MO		Operational voltage DC
5811592540				24 V
5811592440				-
5811593540				24 V
5811593440				-
5811790540				24 V
5811790440				-
5811791540				24 V
5811791440				-
5811792540				24 V
5811792440				-
5811793540				24 V
5811793440				-

Part No.	Operational voltage AC 50 Hz	Voltage tolerance DC	Voltage tolerance AC 50 Hz
5811490540	42 V	-10% / +10%	-10% / +10%
5811490440	230 V	-	-10% / +10%
5811491540	42 V	-10% / +10%	-10% / +10%
5811491440	230 V	-	-10% / +10%
5811492540	42 V	-10% / +10%	-10% / +10%
5811492440	230 V	-	-10% / +10%
5811493540	42 V	-10% / +10%	-10% / +10%
5811493440	230 V	-	-10% / +10%
5811590540	42 V	-10% / +10%	-10% / +10%
5811590440	230 V	-	-10% / +10%
5811591540	42 V	-10% / +10%	-10% / +10%
5811591440	230 V	-	-10% / +10%
5811592540	42 V	-10% / +10%	-10% / +10%
5811592440	230 V	-	-10% / +10%
5811593540	42 V	-10% / +10%	-10% / +10%
5811593440	230 V	-	-10% / +10%
5811790540	42 V	-10% / +10%	-10% / +10%
5811790440	230 V	-	-10% / +10%
5811791540	42 V	-10% / +10%	-10% / +10%
5811791440	230 V	-	-10% / +10%
5811792540	42 V	-10% / +10%	-10% / +10%
5811792440	230 V	-	-10% / +10%
5811793540	42 V	-10% / +10%	-10% / +10%
5811793440	230 V	-	-10% / +10%

Part No.	Power consumption DC	Holding power AC 50 Hz	Switch-on power AC 50 Hz	Pilot
5811490540	6,7 W	7,7 VA	12 VA	Internal
5811490440	-	10,8 VA	15,2 VA	Internal
5811491540	6,7 W	7,7 VA	12 VA	Internal
5811491440	-	10,8 VA	15,2 VA	Internal

Part No.	Power consumption DC	Holding power AC 50 Hz	Switch-on power AC 50 Hz	Pilot
5811492540	6,7 W	7,7 VA	12 VA	External
5811492440	-	10,8 VA	15,2 VA	External
5811493540	6,7 W	7,7 VA	12 VA	External
5811493440	-	10,8 VA	15,2 VA	External
5811590540	6,7 W	7,7 VA	12 VA	Internal
5811590440	-	10,8 VA	15,2 VA	Internal
5811591540	6,7 W	7,7 VA	12 VA	Internal
5811591440	-	10,8 VA	15,2 VA	Internal
5811592540	6,7 W	7,7 VA	12 VA	External
5811592440	-	10,8 VA	15,2 VA	External
5811593540	6,7 W	7,7 VA	12 VA	External
5811593440	-	10,8 VA	15,2 VA	External
5811790540	6,7 W	7,7 VA	12 VA	Internal
5811790440	-	10,8 VA	15,2 VA	Internal
5811791540	6,7 W	7,7 VA	12 VA	Internal
5811791440	-	10,8 VA	15,2 VA	Internal
5811792540	6,7 W	7,7 VA	12 VA	External
5811792440	-	10,8 VA	15,2 VA	External
5811793540	6,7 W	7,7 VA	12 VA	External
5811793440	-	10,8 VA	15,2 VA	External

Part No.	Working pressure min./max.	Electrical connection Pilot valve	Throttle
5811490540	3 ... 16 bar	Plug EN 175301-803, form A	-
5811490440	3 ... 16 bar	Plug EN 175301-803, form A	-
5811491540	3 ... 16 bar	Plug EN 175301-803, form A	with throttle
5811491440	3 ... 16 bar	Plug EN 175301-803, form A	with throttle
5811492540	-0,95 ... 16 bar	Plug EN 175301-803, form A	-
5811492440	-0,95 ... 16 bar	Plug EN 175301-803, form A	-
5811493540	-0,95 ... 16 bar	Plug EN 175301-803, form A	with throttle
5811493440	-0,95 ... 16 bar	Plug EN 175301-803, form A	with throttle
5811590540	3 ... 16 bar	Plug EN 175301-803, form A	-
5811590440	3 ... 16 bar	Plug EN 175301-803, form A	-
5811591540	3 ... 16 bar	Plug EN 175301-803, form A	with throttle
5811591440	3 ... 16 bar	Plug EN 175301-803, form A	with throttle
5811592540	-0,95 ... 16 bar	Plug EN 175301-803, form A	-
5811592440	-0,95 ... 16 bar	Plug EN 175301-803, form A	-
5811593540	-0,95 ... 16 bar	Plug EN 175301-803, form A	with throttle
5811593440	-0,95 ... 16 bar	Plug EN 175301-803, form A	with throttle
5811790540	3 ... 16 bar	Plug EN 175301-803, form A	-
5811790440	3 ... 16 bar	Plug EN 175301-803, form A	-
5811791540	3 ... 16 bar	Plug EN 175301-803, form A	with throttle
5811791440	3 ... 16 bar	Plug EN 175301-803, form A	with throttle
5811792540	-0,95 ... 16 bar	Plug EN 175301-803, form A	-
5811792440	-0,95 ... 16 bar	Plug EN 175301-803, form A	-
5811793540	-0,95 ... 16 bar	Plug EN 175301-803, form A	with throttle
5811793440	-0,95 ... 16 bar	Plug EN 175301-803, form A	with throttle



Nominal flow  $Q_n$  at 6 bar and  $\Delta p = 1$  bar, MO = Manual override

MO = Manual override

## Technical information

The min. control pressure must be adhered to, since otherwise faulty switching and valve failure may result!

The pressure dew point must be at least 15 °C under ambient and medium temperature and may not exceed 3 °C .

The oil content of compressed air must remain constant during the life cycle.

Use only the approved oils from AVENTICS. Further information can be found in the "Technical information" document (available in the MediaCentre).

## Technical information

Housing	Aluminum
Seals	Acrylonitrile butadiene rubber

## Dimensions

### Dimensions

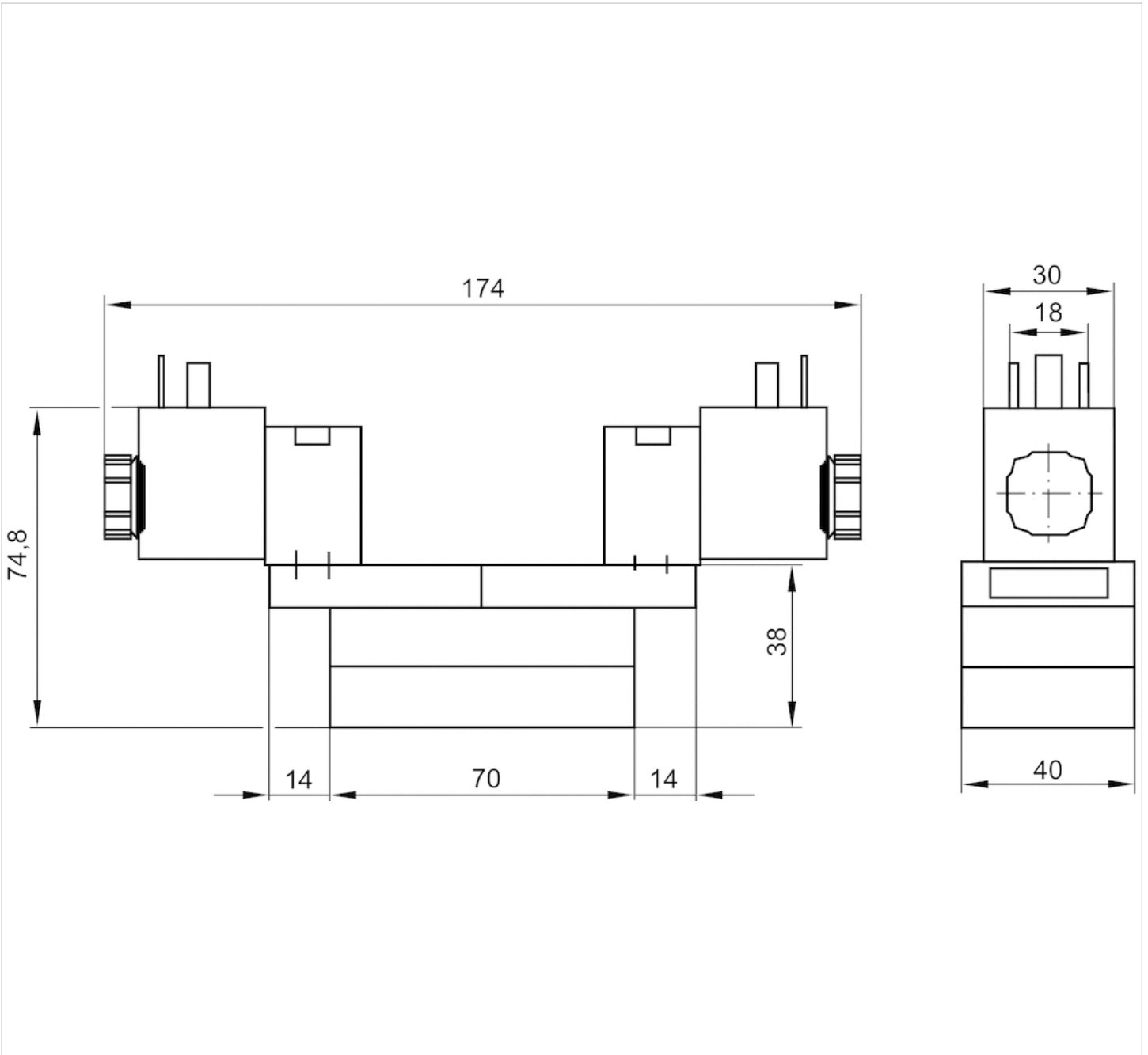

# 5/3-directional valve, Series 581, size 1

- ISO 5599-1
- ISO 1
- 5/3
- closed center exhausted center pressurized center
- $Q_n = 1100$  l/min
- Compressed air connection output Base plate ISO 5599-1
- Electrical connection Plug, EN 175301-803, form A
- Manual override with detent, without detent



Type	Spool valve
Sealing principle	Soft sealing
Blocking principle	Single base plate principle
Connection type	Plate connection
Standards	ISO 5599-1, ISO 1
Working pressure min./max.	See table below
Control pressure min./max.	3 ... 10 bar
Ambient temperature min./max.	-15 ... 50 °C
Medium temperature min./max.	-15 ... 50 °C
Medium	Compressed air
Max. particle size	50 µm
Oil content of compressed air	0 ... 5 mg/m <sup>3</sup>
Nominal flow $Q_n$	1100 l/min
Flow conductance C	4,3 l/(s*bar)
Protection class with connection	IP65
Compatibility index	14
Duty cycle	100 %
Typ. switch-on time	14 ms
Typ. switch-off time	28 ms
Mounting screw	with hexagon socket
Mounting screw tightening torque	2 Nm
Weight	0,5 kg



Part No.	Operational voltage AC 50 Hz	Voltage tolerance DC	Voltage tolerance AC 50 Hz
5811790650	-	-10% / +10%	-
5811790450	230 V	-	-10% / +10%
5811791650	-	-10% / +10%	-
5811791450	230 V	-	-10% / +10%
5811792650	-	-10% / +10%	-
5811792450	230 V	-	-10% / +10%
5811793650	-	-10% / +10%	-
5811793450	230 V	-	-10% / +10%

Part No.	Power consumption DC	Holding power AC 50 Hz	Switch-on power AC 50 Hz	Pilot
5811490650	2 W	-	-	Internal
5811490450	-	4,8 VA	7 VA	Internal
5811491650	2 W	-	-	Internal
5811491450	-	4,8 VA	7 VA	Internal
5811492650	2 W	-	-	External
5811492450	-	4,8 VA	7 VA	External
5811493650	2 W	-	-	External
5811493450	-	4,8 VA	7 VA	External
5811590650	2 W	-	-	Internal
5811590450	-	4,8 VA	7 VA	Internal
5811591650	2 W	-	-	Internal
5811591450	-	4,8 VA	7 VA	Internal
5811592650	2 W	-	-	External
5811592450	-	4,8 VA	7 VA	External
5811593650	2 W	-	-	External
5811593450	-	4,8 VA	7 VA	External
5811790650	2 W	-	-	Internal
5811790450	-	4,8 VA	7 VA	Internal
5811791650	2 W	-	-	Internal
5811791450	-	4,8 VA	7 VA	Internal
5811792650	2 W	-	-	External
5811792450	-	4,8 VA	7 VA	External
5811793650	2 W	-	-	External
5811793450	-	4,8 VA	7 VA	External

Part No.	Working pressure min./max.	Compatibility index	Electrical connection Pilot valve
5811490650	3 ... 10 bar	14	Plug EN 175301-803, form A
5811490450	3 ... 10 bar	14	Plug EN 175301-803, form A
5811491650	3 ... 10 bar	14	Plug EN 175301-803, form A
5811491450	3 ... 10 bar	14	Plug EN 175301-803, form A
5811492650	-0,95 ... 10 bar	14	Plug EN 175301-803, form A
5811492450	-0,95 ... 10 bar	14	Plug EN 175301-803, form A
5811493650	-0,95 ... 10 bar	14	Plug EN 175301-803, form A
5811493450	-0,95 ... 10 bar	14	Plug EN 175301-803, form A

Part No.	Working pressure min./max.	Compatibility index	Electrical connection Pilot valve
5811590650	3 ... 10 bar	14	Plug EN 175301-803, form A
5811590450	3 ... 10 bar	14	Plug EN 175301-803, form A
5811591650	3 ... 10 bar	14	Plug EN 175301-803, form A
5811591450	3 ... 10 bar	14	Plug EN 175301-803, form A
5811592650	-0,95 ... 10 bar	14	Plug EN 175301-803, form A
5811592450	-0,95 ... 10 bar	14	Plug EN 175301-803, form A
5811593650	-0,95 ... 10 bar	14	Plug EN 175301-803, form A
5811593450	-0,95 ... 10 bar	14	Plug EN 175301-803, form A
5811790650	3 ... 10 bar	14	Plug EN 175301-803, form A
5811790450	3 ... 10 bar	14	Plug EN 175301-803, form A
5811791650	3 ... 10 bar	14	Plug EN 175301-803, form A
5811791450	3 ... 10 bar	14	Plug EN 175301-803, form A
5811792650	-0,95 ... 10 bar	14	Plug EN 175301-803, form A
5811792450	-0,95 ... 10 bar	14	Plug EN 175301-803, form A
5811793650	-0,95 ... 10 bar	14	Plug EN 175301-803, form A
5811793450	-0,95 ... 10 bar	14	Plug EN 175301-803, form A

Part No.	Throttle
5811490650	-
5811490450	-
5811491650	with throttle
5811491450	with throttle
5811492650	-
5811492450	-
5811493650	with throttle
5811493450	with throttle
5811590650	-
5811590450	-
5811591650	with throttle
5811591450	with throttle
5811592650	-
5811592450	-
5811593650	with throttle
5811593450	with throttle
5811790650	-
5811790450	-
5811791650	with throttle
5811791450	with throttle
5811792650	-
5811792450	-
5811793650	with throttle
5811793450	with throttle

Nominal flow  $Q_n$  at 6 bar and  $\Delta p = 1$  bar, MO = Manual override, An operating pressure of up to 16 bar is possible in the version with manual override without detent.

## Technical information

The min. control pressure must be adhered to, since otherwise faulty switching and valve failure may result!

The pressure dew point must be at least 15 °C under ambient and medium temperature and may not exceed 3 °C .

The oil content of compressed air must remain constant during the life cycle.

Use only the approved oils from AVENTICS. Further information can be found in the "Technical information" document (available in the MediaCentre).

## Technical information

Housing	Aluminum
Seals	Acrylonitrile butadiene rubber

# Dimensions

## Dimensions

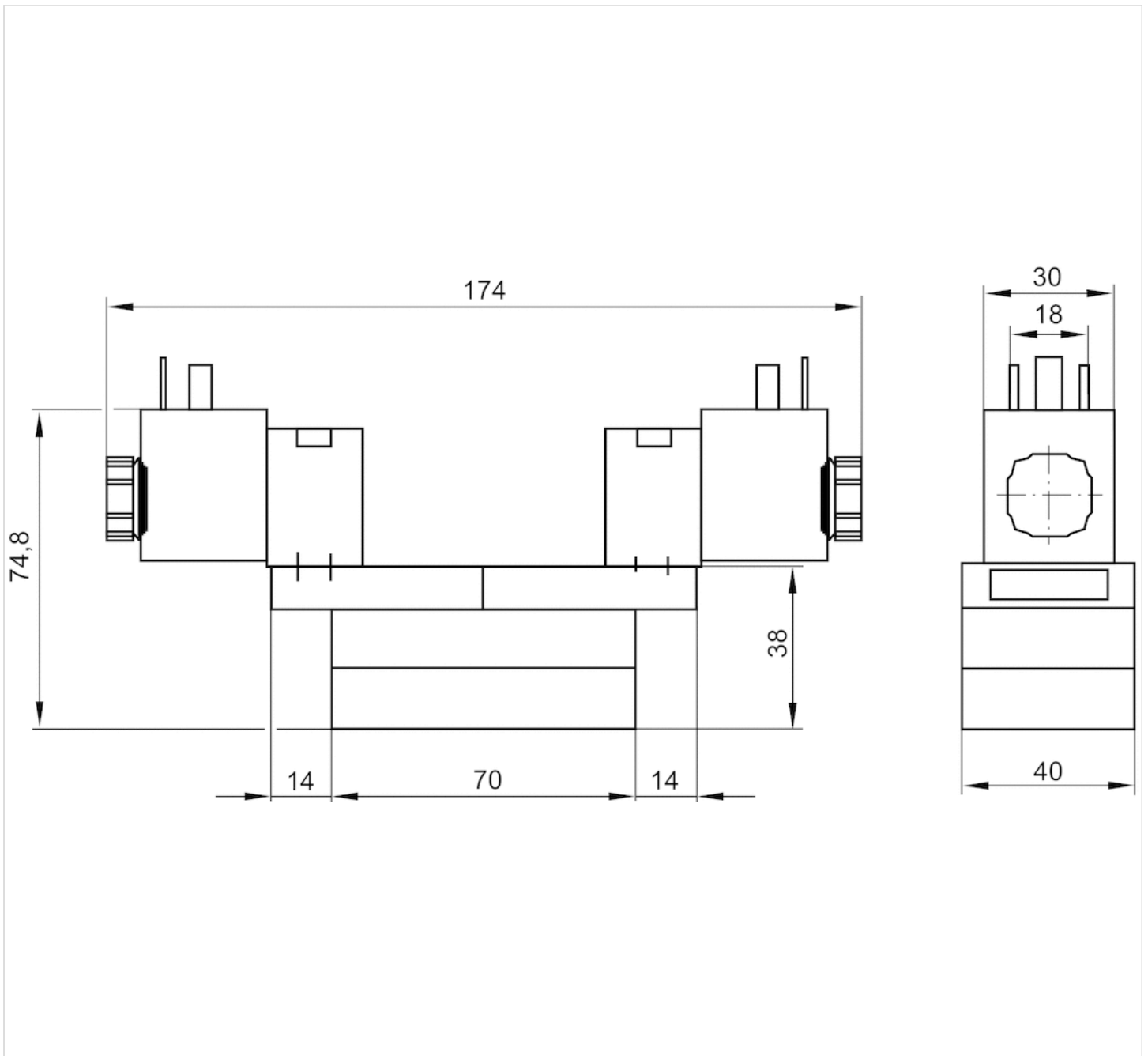







# 5/3-directional valve, Series 581, size 1

- ISO 5599-1
- ISO 1
- 5/3
- closed center exhausted center pressurized center
- Qn = 1100 l/min
- Compressed air connection output Base plate ISO 5599-1
- Electrical connection Plug, EN 175301-803, form A
- Manual override without

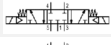
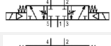
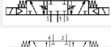
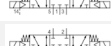
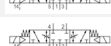
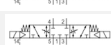
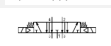

Type	Spool valve
Sealing principle	Soft sealing
Blocking principle	Single base plate principle
Connection type	Plate connection
Standards	ISO 5599-1, ISO 1
Working pressure min./max.	See table below
Control pressure min./max.	3 ... 16 bar
Ambient temperature min./max.	-15 ... 50 °C
Medium temperature min./max.	-15 ... 50 °C
Medium	Compressed air
Max. particle size	50 µm
Oil content of compressed air	0 ... 5 mg/m <sup>3</sup>
Nominal flow Qn	1100 l/min
Flow conductance C	4,3 l/(s*bar)
Protection class with connection	IP65
Duty cycle	100 %
Typ. switch-on time	14 ms
Typ. switch-off time	28 ms
Mounting screw	with hexagon socket
Mounting screw tightening torque	2 Nm
Weight	0,5 kg

## Technical data

Part No.			Operational voltage DC	Operational voltage AC 50 Hz
5811490530		closed center	24 V	-
5811490430		closed center	-	230 V
5811491530		closed center	24 V	-
5811491430		closed center	-	230 V
5811492530		closed center	24 V	-
5811492430		closed center	-	230 V
5811493530		closed center	24 V	-
5811493430		closed center	-	230 V
5811590530		exhausted center	24 V	-
5811590430		exhausted center	-	230 V
5811591530		exhausted center	24 V	-
5811591430		exhausted center	-	230 V

Part No.			Operational voltage DC	Operational voltage AC 50 Hz
5811592530		exhausted center	24 V	-
5811592430		exhausted center	-	230 V
5811593430		exhausted center	-	230 V
5811790530		pressurized center	24 V	-
5811790430		pressurized center	-	230 V
5811791530		pressurized center	24 V	-
5811791430		pressurized center	-	230 V
5811792530		pressurized center	24 V	-
5811792430		pressurized center	-	230 V
5811793530		pressurized center	24 V	-
5811793430		pressurized center	-	230 V

Part No.	Voltage tolerance DC	Voltage tolerance AC 50 Hz	Power consumption DC	Holding power AC 50 Hz
5811490530	-10% / +10%	-	6,7 W	-
5811490430	-	-10% / +10%	-	10,8 VA
5811491530	-10% / +10%	-	6,7 W	-
5811491430	-	-10% / +10%	-	10,8 VA
5811492530	-10% / +10%	-	6,7 W	-
5811492430	-	-10% / +10%	-	10,8 VA
5811493530	-10% / +10%	-	6,7 W	-
5811493430	-	-10% / +10%	-	10,8 VA
5811590530	-10% / +10%	-	6,7 W	-
5811590430	-	-10% / +10%	-	10,8 VA
5811591530	-10% / +10%	-	6,7 W	-
5811591430	-	-10% / +10%	-	10,8 VA
5811592530	-10% / +10%	-	6,7 W	-
5811592430	-	-10% / +10%	-	10,8 VA
5811593430	-	-10% / +10%	-	10,8 VA
5811790530	-10% / +10%	-	6,7 W	-
5811790430	-	-10% / +10%	-	10,8 VA
5811791530	-10% / +10%	-	6,7 W	-
5811791430	-	-10% / +10%	-	10,8 VA
5811792530	-10% / +10%	-	6,7 W	-
5811792430	-	-10% / +10%	-	10,8 VA
5811793530	-10% / +10%	-	6,7 W	-
5811793430	-	-10% / +10%	-	10,8 VA

Part No.	Switch-on power AC 50 Hz	Pilot	Working pressure min./max.
5811490530	-	Internal	3 ... 16 bar
5811490430	15,2 VA	Internal	3 ... 16 bar
5811491530	-	Internal	3 ... 16 bar
5811491430	15,2 VA	Internal	3 ... 16 bar
5811492530	-	External	-0,95 ... 16 bar
5811492430	15,2 VA	External	-0,95 ... 16 bar

Part No.	Switch-on power AC 50 Hz	Pilot	Working pressure min./max.
5811493530	-	External	-0,95 ... 16 bar
5811493430	15,2 VA	External	-0,95 ... 16 bar
5811590530	-	Internal	3 ... 16 bar
5811590430	15,2 VA	Internal	3 ... 16 bar
5811591530	-	Internal	3 ... 16 bar
5811591430	15,2 VA	Internal	3 ... 16 bar
5811592530	-	External	-0,95 ... 16 bar
5811592430	15,2 VA	External	-0,95 ... 16 bar
5811593430	15,2 VA	External	-0,95 ... 16 bar
5811790530	-	Internal	3 ... 16 bar
5811790430	15,2 VA	Internal	3 ... 16 bar
5811791530	-	Internal	3 ... 16 bar
5811791430	15,2 VA	Internal	3 ... 16 bar
5811792530	-	External	-0,95 ... 16 bar
5811792430	15,2 VA	External	-0,95 ... 16 bar
5811793530	-	External	-0,95 ... 16 bar
5811793430	15,2 VA	External	-0,95 ... 16 bar

Part No.	Electrical connection Pilot valve	Throttle
5811490530	Plug EN 175301-803, form A	-
5811490430	Plug EN 175301-803, form A	-
5811491530	Plug EN 175301-803, form A	with throttle
5811491430	Plug EN 175301-803, form A	with throttle
5811492530	Plug EN 175301-803, form A	-
5811492430	Plug EN 175301-803, form A	-
5811493530	Plug EN 175301-803, form A	with throttle
5811493430	Plug EN 175301-803, form A	with throttle
5811590530	Plug EN 175301-803, form A	-
5811590430	Plug EN 175301-803, form A	-
5811591530	Plug EN 175301-803, form A	with throttle
5811591430	Plug EN 175301-803, form A	with throttle
5811592530	Plug EN 175301-803, form A	-
5811592430	Plug EN 175301-803, form A	-
5811593430	Plug EN 175301-803, form A	with throttle
5811790530	Plug EN 175301-803, form A	-
5811790430	Plug EN 175301-803, form A	-
5811791530	Plug EN 175301-803, form A	with throttle
5811791430	Plug EN 175301-803, form A	with throttle
5811792530	Plug EN 175301-803, form A	-
5811792430	Plug EN 175301-803, form A	-
5811793530	Plug EN 175301-803, form A	with throttle
5811793430	Plug EN 175301-803, form A	with throttle

Nominal flow Q<sub>n</sub> at 6 bar and Δp = 1 bar

## Technical information

The min. control pressure must be adhered to, since otherwise faulty switching and valve failure may result!

The pressure dew point must be at least 15 °C under ambient and medium temperature and may not exceed 3 °C .

The oil content of compressed air must remain constant during the life cycle.

Use only the approved oils from AVENTICS. Further information can be found in the "Technical information" document (available in the MediaCentre).

## Technical information

Housing	Aluminum
Seals	Acrylonitrile butadiene rubber

## Dimensions

### Dimensions

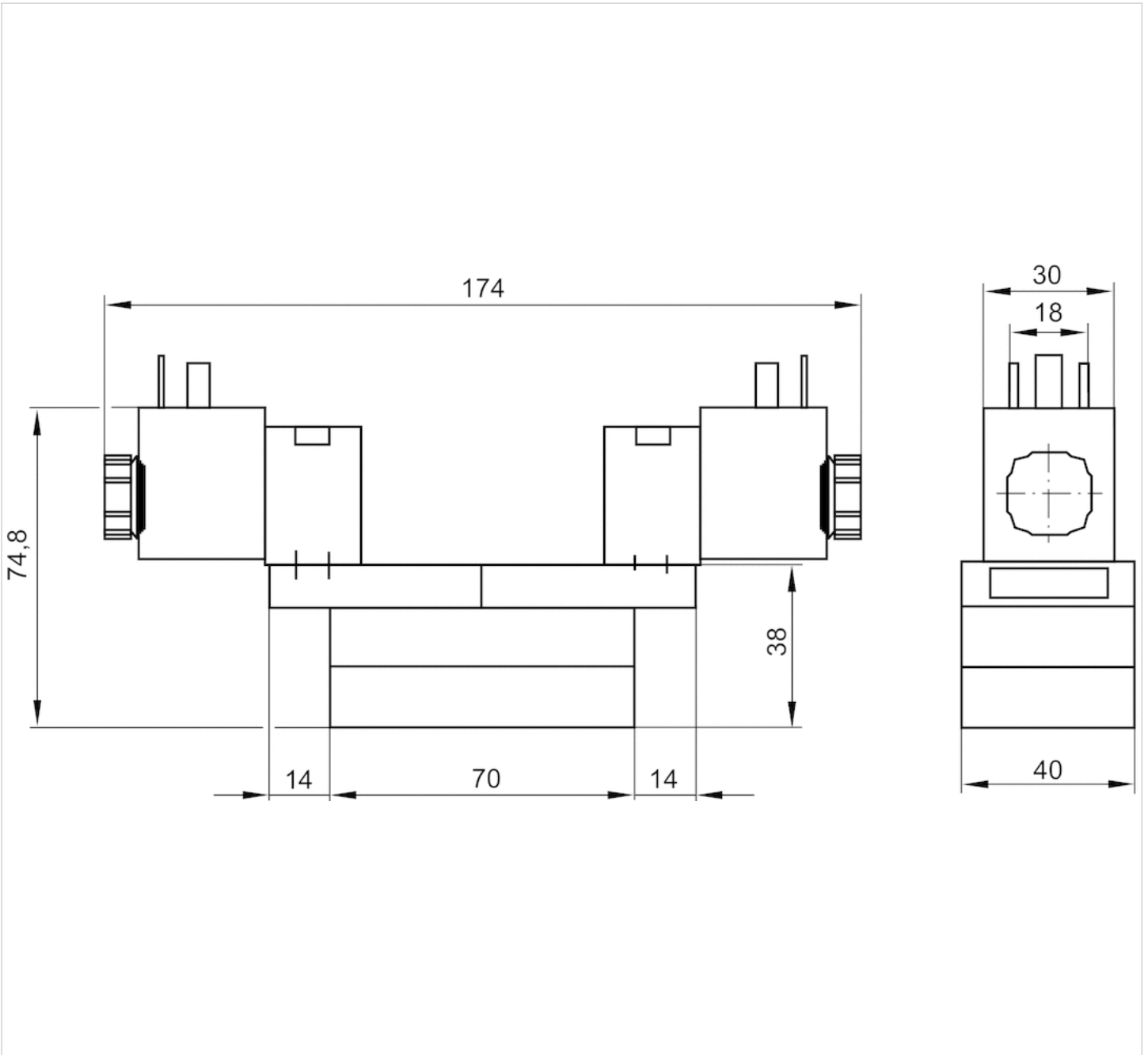











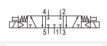



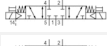



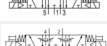

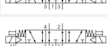

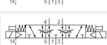

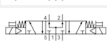
# 5/3-directional valve, Series 581, size 1

- ISO 5599-1
- ISO 1
- 5/3
- closed center exhausted center pressurized center
- Qn = 1100 l/min
- Compressed air connection output Base plate ISO 5599-1
- Electrical connection Plug, EN 175301-803, form A
- Manual override without detent

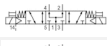

Type	Spool valve
Sealing principle	Soft sealing
Blocking principle	Single base plate principle
Connection type	Plate connection
Standards	ISO 5599-1, ISO 1
Working pressure min./max.	See table below
Control pressure min./max.	3 ... 10 bar
Ambient temperature min./max.	-15 ... 50 °C
Medium temperature min./max.	-15 ... 50 °C
Medium	Compressed air
Max. particle size	50 µm
Oil content of compressed air	0 ... 5 mg/m <sup>3</sup>
Nominal flow Qn	1100 l/min
Flow conductance C	4,3 l/(s*bar)
Protection class with connection	IP65
Duty cycle	100 %
Typ. switch-on time	14 ms
Typ. switch-off time	28 ms
Mounting screw	with hexagon socket
Mounting screw tightening torque	2 Nm
Weight	0,58 kg

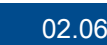
## Technical data

Part No.		MO		Operational voltage DC
5811490190			closed center	24 V
5811491190			closed center	24 V
5811492190			closed center	24 V
5811493190			closed center	24 V
5811590190			exhausted center	24 V
5811591190			exhausted center	24 V
5811592190			exhausted center	24 V
5811593190			exhausted center	24 V
5811790190			pressurized center	24 V
5811791190			pressurized center	24 V
5811792190			pressurized center	24 V
5811793190			pressurized center	24 V

Part No.	Voltage tolerance DC	Power consumption DC	Pilot	Working pressure min./max.
5811490190	-10% / +10%	6 W	Internal	3 ... 10 bar
5811491190	-10% / +10%	6 W	Internal	3 ... 10 bar
5811492190	-10% / +10%	6 W	External	-0,95 ... 10 bar
5811493190	-10% / +10%	6 W	External	-0,95 ... 10 bar
5811590190	-10% / +10%	6 W	Internal	3 ... 10 bar
5811591190	-10% / +10%	6 W	Internal	3 ... 10 bar
5811592190	-10% / +10%	6 W	External	-0,95 ... 10 bar
5811593190	-10% / +10%	6 W	External	-0,95 ... 10 bar
5811790190	-10% / +10%	6 W	Internal	3 ... 10 bar
5811791190	-10% / +10%	6 W	Internal	3 ... 10 bar
5811792190	-10% / +10%	6 W	External	-0,95 ... 10 bar
5811793190	-10% / +10%	6 W	External	-0,95 ... 10 bar

Part No.	Electrical connection Pilot valve	Throttle
5811490190	Plug EN 175301-803, form A	-
5811491190	Plug EN 175301-803, form A	with throttle
5811492190	Plug EN 175301-803, form A	-
5811493190	Plug EN 175301-803, form A	with throttle
5811590190	Plug EN 175301-803, form A	-
5811591190	Plug EN 175301-803, form A	with throttle
5811592190	Plug EN 175301-803, form A	-
5811593190	Plug EN 175301-803, form A	with throttle
5811790190	Plug EN 175301-803, form A	-
5811791190	Plug EN 175301-803, form A	with throttle
5811792190	Plug EN 175301-803, form A	-
5811793190	Plug EN 175301-803, form A	with throttle

Nominal flow Qn at 6 bar and  $\Delta p = 1$  bar, MO = Manual override

## Technical information

The min. control pressure must be adhered to, since otherwise faulty switching and valve failure may result!

The pressure dew point must be at least 15 °C under ambient and medium temperature and may not exceed 3 °C .

The oil content of compressed air must remain constant during the life cycle.

Use only the approved oils from AVENTICS. Further information can be found in the "Technical information" document (available in the MediaCentre).

## Technical information

Housing	Aluminum
Seals	Acrylonitrile butadiene rubber

## Dimensions

### Dimensions

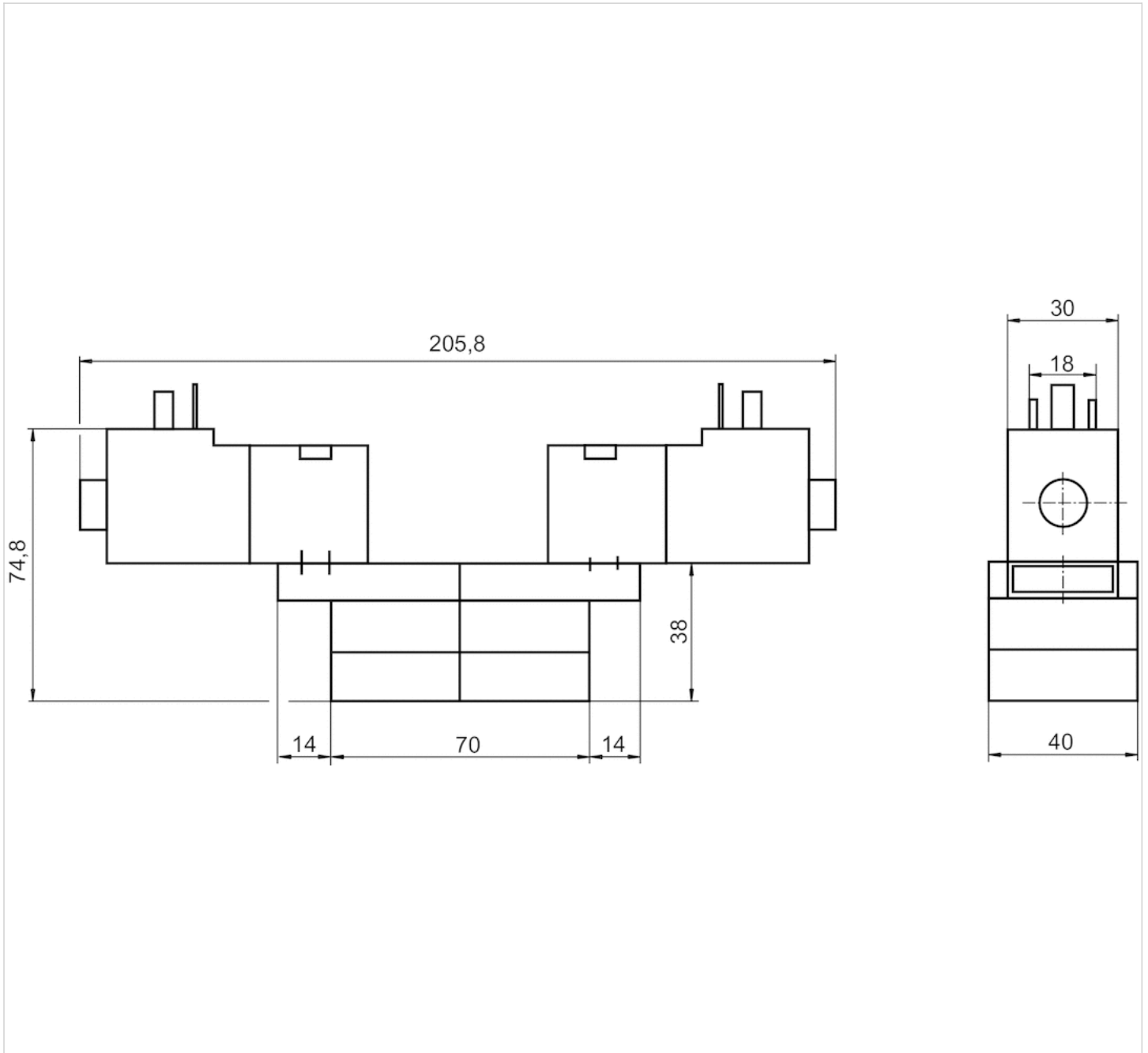



# 5/3-directional valve, Series 581, size 1

- ISO 5599-1
- ISO 1
- 5/3
- Archive product: Do not use in new constructions!
- exhausted center
- $Q_n = 1100 \text{ l/min}$
- Compressed air connection output Base plate ISO 5599-1
- Electrical connection Plug, EN 175301-803, form A
- Manual override without

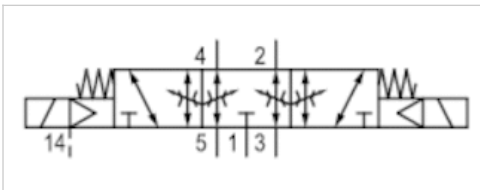

Type	Spool valve
Pilot	External
Sealing principle	Soft sealing
Blocking principle	Single base plate principle
Connection type	Plate connection
Throttle	with throttle
Standards	ISO 5599-1, ISO 1
Working pressure min./max.	-0,95 ... 16 bar
Control pressure min./max.	3 ... 16 bar
Ambient temperature min./max.	-15 ... 50 °C
Medium temperature min./max.	-15 ... 50 °C
Medium	Compressed air
Max. particle size	50 µm
Oil content of compressed air	0 ... 5 mg/m <sup>3</sup>
Nominal flow $Q_n$	1100 l/min
Flow conductance C	4,3 l/(s*bar)
Protection class with connection	IP65
Duty cycle	100 %
Typ. switch-on time	14 ms
Typ. switch-off time	28 ms
Mounting screw	with hexagon socket
Mounting screw tightening torque	2 Nm
Weight	0,5 kg

## Technical data

Part No.		Operational voltage DC	Voltage tolerance DC
5811593530	exhausted center	24 V	-10% / +10%

Part No.	Power consumption DC	Electrical connection Pilot valve	Throttle
5811593530	6,7 W	Plug EN 175301-803, form A	with throttle

Nominal flow  $Q_n$  at 6 bar and  $\Delta p = 1 \text{ bar}$

## Technical information

The min. control pressure must be adhered to, since otherwise faulty switching and valve failure may result!

The pressure dew point must be at least 15 °C under ambient and medium temperature and may not exceed 3 °C .

The oil content of compressed air must remain constant during the life cycle.

Use only the approved oils from AVENTICS. Further information can be found in the "Technical information" document (available in the MediaCentre).

## Technical information

Housing	Aluminum
Seals	Acrylonitrile butadiene rubber

## Dimensions

### Dimensions

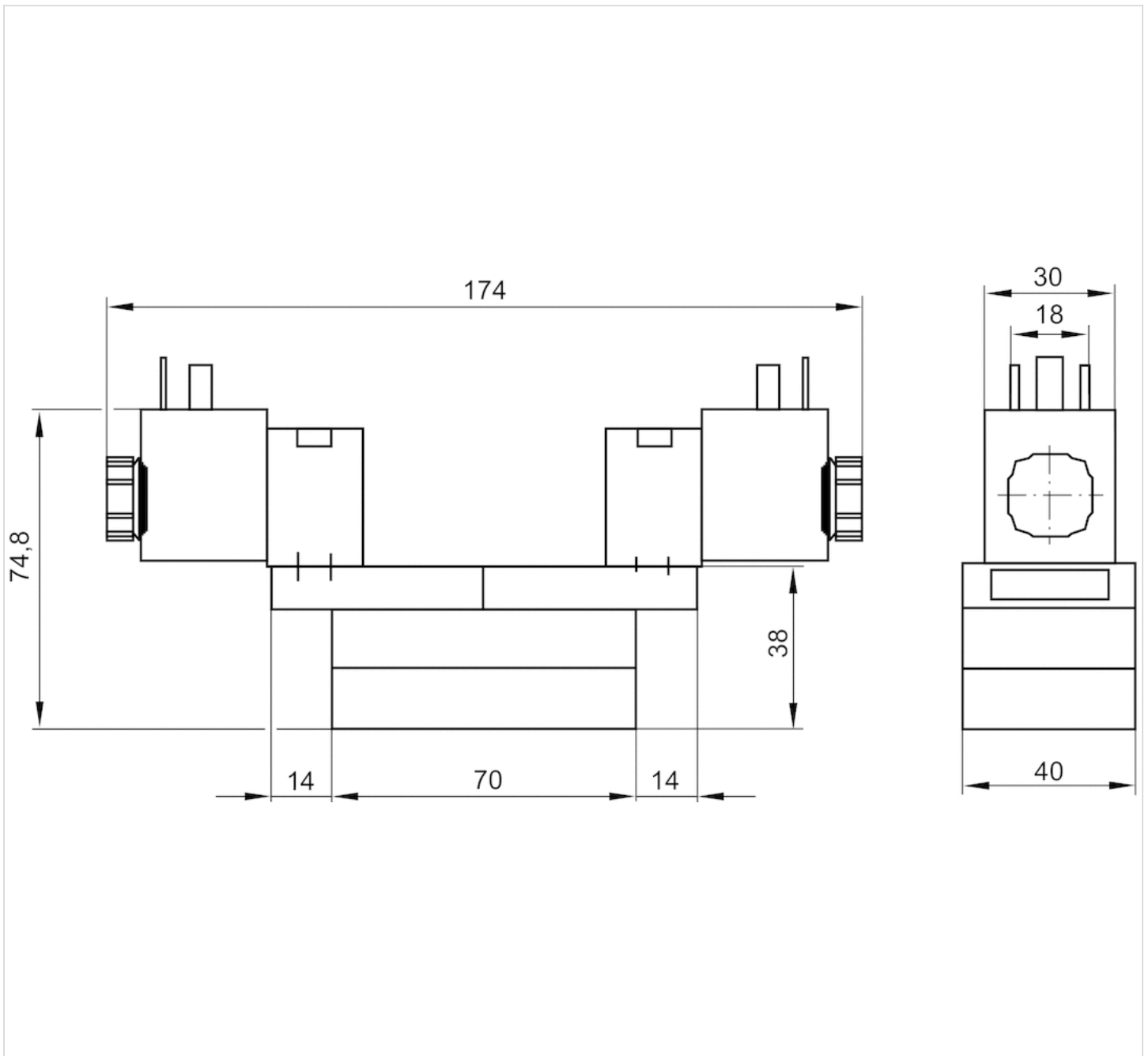

# 2x3/2-directional valve, Series 581, size





## 1

- ISO 5599-1
- ISO 1
- 2x3/2
- NC/NC
- Qn = 950 l/min
- Compressed air connection output Base plate ISO 5599-1
- Electrical connection Plug, M12, 4-pin
- Manual override with detent without detent



Type	Spool valve
Pilot	External
Sealing principle	Soft sealing
Blocking principle	Single base plate principle
Connection type	Plate connection
Standards	ISO 5599-1, ISO 1
Working pressure min./max.	0 ... 8 bar
Control pressure min./max.	3.5 ... 8 bar
Ambient temperature min./max.	0 ... 50 °C
Medium temperature min./max.	0 ... 50 °C
Medium	Compressed air
Max. particle size	5 µm
Oil content of compressed air	0 ... 5 mg/m <sup>3</sup>
Nominal flow Qn	950 l/min
Flow conductance C	3.2 l/(s*bar)
Protection class with connection	IP65
Duty cycle	100 %
Typ. switch-on time	12 ms
Typ. switch-off time	25 ms
Mounting screw	with hexagon socket
Mounting screw tightening torque	2 Nm
Weight	0.18 kg

## Technical data

Part No.		MO		Operational voltage DC	Voltage tolerance DC
5811822720			NC/NC	24 V	-10% / +10%
5811822710			NC/NC	24 V	-10% / +10%

Part No.	Power consumption DC	Electrical connection Pilot valve
5811822720	0.35 W	Plug M12 4-pin
5811822710	0.35 W	Plug M12 4-pin

Connection 12 must be connected with atmospheres, The valve must be supplied with compressed air via ports 3 and 5, Nominal flow Qn at 6 bar and  $\Delta p = 1$  bar, MO = Manual override

## Technical information

The min. control pressure must be adhered to, since otherwise faulty switching and valve failure may result!

The pressure dew point must be at least 15 °C under ambient and medium temperature and may not exceed 3 °C .

The oil content of compressed air must remain constant during the life cycle.

Use only the approved oils from AVENTICS. Further information can be found in the "Technical information" document (available in the MediaCentre).

Switch-on power: 1 W for 40 ms

## Technical information

Housing	Polyamide fiber-glass reinforced
Seals	Acrylonitrile butadiene rubber

# Dimensions

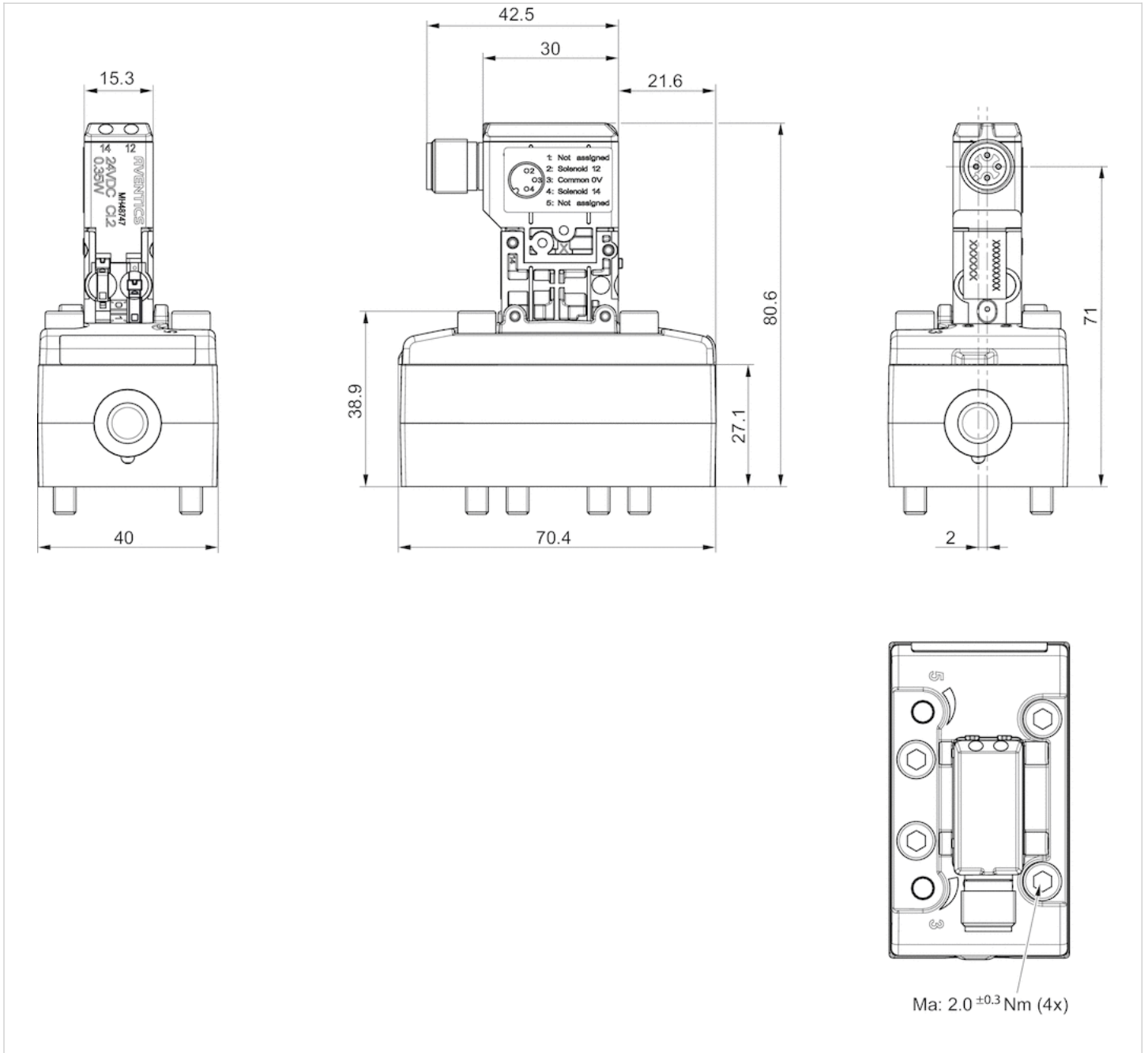

## Pin assignments

### Pin assignments

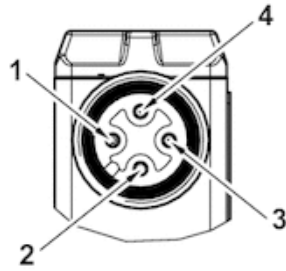

- 1) not assigned
- 2) Coil 12
- 3) 0 V DC
- 4) Coil 14

















# 5/2-directional valve, Series 581, size 1

- ISO 5599-1
- ISO 1
- 5/2
- With differential piston
- With air spring return
- $Q_n = 1400$  l/min
- Compressed air connection output Base plate ISO 5599-1
- Electrical connection Plug, M12, 4-pin
- Manual override with detent without detent



Type	Spool valve
Sealing principle	Soft sealing
Blocking principle	Single base plate principle
Connection type	Plate connection
Standards	ISO 5599-1, ISO 1
Working pressure min./max.	-0.95 ... 10 bar
Control pressure min./max.	3 ... 10 bar
Ambient temperature min./max.	0 ... 50 °C
Medium temperature min./max.	See table below
Medium	Compressed air
Max. particle size	5 µm
Oil content of compressed air	0 ... 5 mg/m <sup>3</sup>
Nominal flow $Q_n$	1400 l/min
Flow conductance C	5.2 l/(s*bar)
Protection class with connection	IP65
Duty cycle	100 %
Typ. switch-on time	12 ms
Typ. switch-off time	25 ms
Mounting screw	with hexagon socket
Mounting screw tightening torque	2 Nm
Weight	0.2 kg

## Technical data

Part No.		MO	Operational voltage DC	Voltage tolerance DC
5811611720			24 V	-10% / +10%
5811611710			24 V	-10% / +10%
5811613720			24 V	-10% / +10%
5811613710			24 V	-10% / +10%
5811612720			24 V	-10% / +10%
5811612710			24 V	-10% / +10%
5811610720			24 V	-10% / +10%
5811610710			24 V	-10% / +10%



Part No.	Power consumption DC	Pilot	Medium temperature min./max.
5811611720	0.35 W	Internal	0 ... 50 °C
5811611710	0.35 W	Internal	0 ... 60 °C
5811613720	0.35 W	External	0 ... 50 °C
5811613710	0.35 W	External	0 ... 50 °C
5811612720	0.35 W	External	0 ... 50 °C
5811612710	0.35 W	External	0 ... 50 °C
5811610720	0.35 W	Internal	0 ... 50 °C
5811610710	0.35 W	Internal	0 ... 50 °C

Part No.	Electrical connection Pilot valve	Throttle	
5811611720	Plug M12 4-pin	with throttle	1)
5811611710	Plug M12 4-pin	with throttle	2)
5811613720	Plug M12 4-pin	with throttle	1)
5811613710	Plug M12 4-pin	with throttle	1)
5811612720	Plug M12 4-pin	-	1)
5811612710	Plug M12 4-pin	-	1)
5811610720	Plug M12 4-pin	-	1)
5811610710	Plug M12 4-pin	-	1)

1) Differential piston, signal 14 has priority, Nominal flow Qn at 6 bar and  $\Delta p = 1$  bar, MO = Manual override

2) Differential piston, signal 14 has priority, Connection 12 must be connected with atmospheres, Nominal flow Qn at 6 bar and  $\Delta p = 1$  bar, MO = Manual override

## Technical information

The min. control pressure must be adhered to, since otherwise faulty switching and valve failure may result!

The pressure dew point must be at least 15 °C under ambient and medium temperature and may not exceed 3 °C .

The oil content of compressed air must remain constant during the life cycle.

Use only the approved oils from AVENTICS. Further information can be found in the "Technical information" document (available in the MediaCentre).

Switch-on power: 1 W for 40 ms

## Technical information

Housing	Polyamide fiber-glass reinforced
Seals	Acrylonitrile butadiene rubber

# Dimensions

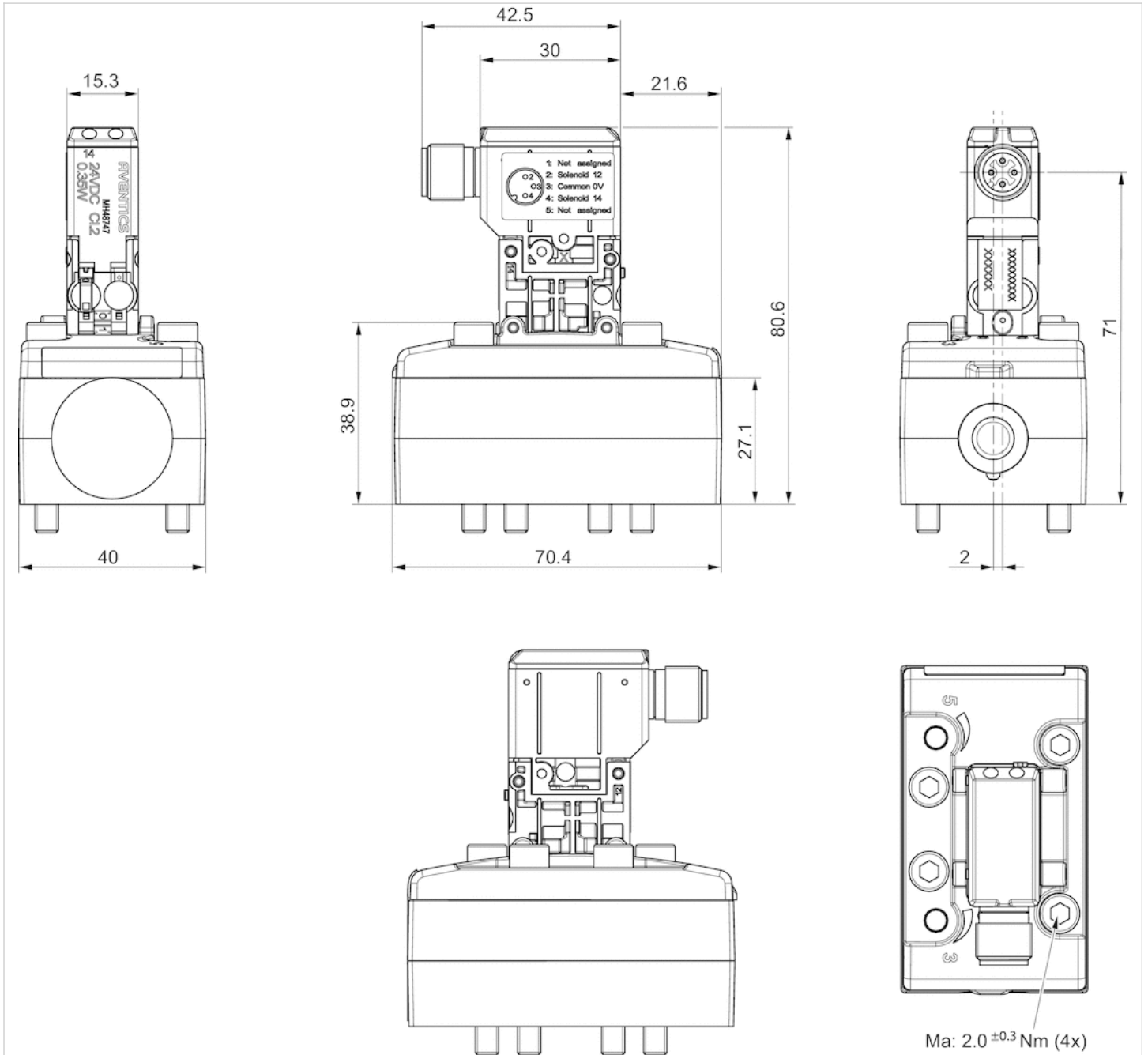

## Pin assignments

### Pin assignments

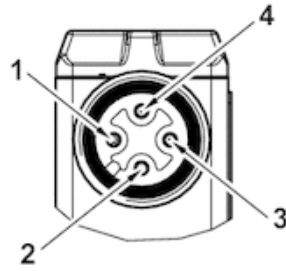

- 1) not assigned
- 2) Coil 12
- 3) 0 V DC
- 4) Coil 14

















# 5/2-directional valve, Series 581, size 1

- ISO 5599-1
- ISO 1
- 5/2
- With spring return
- single solenoid
- $Q_n = 1400$  l/min
- Compressed air connection output Base plate ISO 5599-1
- Electrical connection Plug, M12, 4-pin
- Manual override with detent without detent



Type	Spool valve
Sealing principle	Soft sealing
Blocking principle	Single base plate principle
Connection type	Plate connection
Standards	ISO 5599-1, ISO 1
Working pressure min./max.	-0.95 ... 10 bar
Control pressure min./max.	3 ... 10 bar
Ambient temperature min./max.	0 ... 50 °C
Medium temperature min./max.	0 ... 50 °C
Medium	Compressed air
Max. particle size	5 µm
Oil content of compressed air	0 ... 5 mg/m <sup>3</sup>
Nominal flow $Q_n$	1400 l/min
Flow conductance C	5.2 l/(s*bar)
Protection class with connection	IP65
Duty cycle	100 %
Typ. switch-on time	12 ms
Typ. switch-off time	25 ms
Mounting screw	with hexagon socket
Mounting screw tightening torque	2 Nm
Weight	0.18 kg

## Technical data

Part No.		MO	Operational voltage DC	Voltage tolerance DC
5811112720			24 V	-10% / +10%
5811112710			24 V	-10% / +10%
5811110720			24 V	-10% / +10%
5811110710			24 V	-10% / +10%
5811113720			24 V	-10% / +10%
5811113710			24 V	-10% / +10%
5811111720			24 V	-10% / +10%
5811111710			24 V	-10% / +10%

Part No.	Power consumption DC	Pilot	Electrical connection Pilot valve	Throttle
5811112720	0.35 W	External	Plug M12 4-pin	-
5811112710	0.35 W	External	Plug M12 4-pin	-
5811110720	0.35 W	Internal	Plug M12 4-pin	-
5811110710	0.35 W	Internal	Plug M12 4-pin	-
5811113720	0.35 W	External	Plug M12 4-pin	with throttle
5811113710	0.35 W	External	Plug M12 4-pin	with throttle
5811111720	0.35 W	Internal	Plug M12 4-pin	with throttle
5811111710	0.35 W	Internal	Plug M12 4-pin	with throttle

Connection 12 must be connected with atmospheres, Nominal flow Qn at 6 bar and  $\Delta p = 1$  bar, MO = Manual override

## Technical information

The min. control pressure must be adhered to, since otherwise faulty switching and valve failure may result!

The pressure dew point must be at least 15 °C under ambient and medium temperature and may not exceed 3 °C .

The oil content of compressed air must remain constant during the life cycle.

Use only the approved oils from AVENTICS. Further information can be found in the "Technical information" document (available in the MediaCentre).

Switch-on power: 1 W for 40 ms

## Technical information

Housing	Polyamide fiber-glass reinforced
Seals	Acrylonitrile butadiene rubber

# Dimensions

## Dimensions

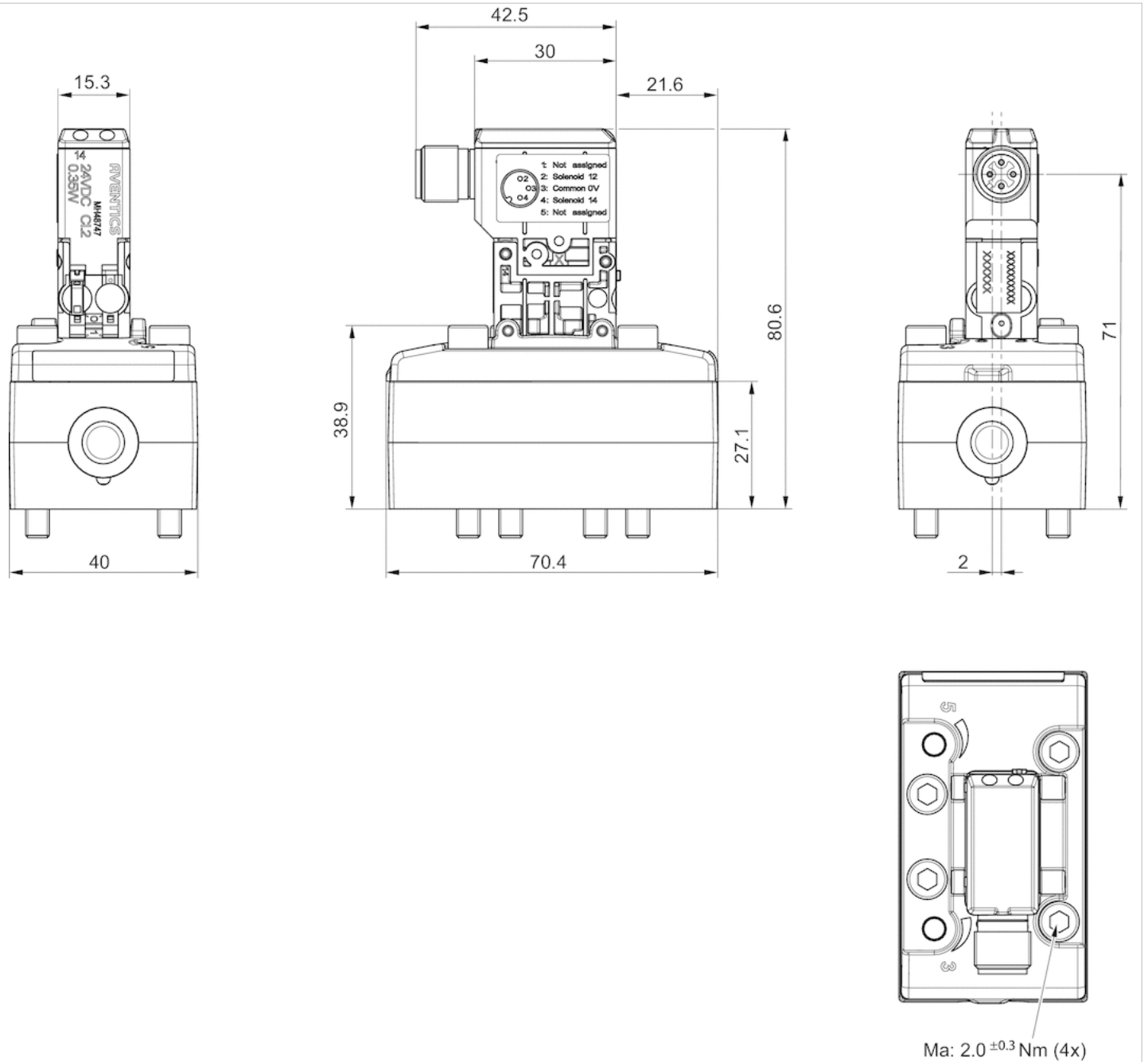

## Pin assignments

### Pin assignments

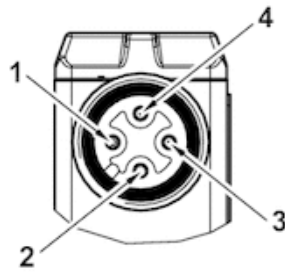

- 1) not assigned
- 2) Coil 12
- 3) 0 V DC
- 4) Coil 14

















# 5/2-directional valve, Series 581, size 1

- ISO 5599-1
- ISO 1
- 5/2
- double solenoid
- Qn = 1400 l/min
- Compressed air connection output Base plate ISO 5599-1
- Electrical connection Plug, M12, 4-pin
- Manual override with detent without detent



Type	Spool valve
Sealing principle	Soft sealing
Blocking principle	Single base plate principle
Connection type	Plate connection
Standards	ISO 5599-1, ISO 1
Working pressure min./max.	-0.95 ... 10 bar
Control pressure min./max.	3 ... 10 bar
Ambient temperature min./max.	0 ... 50 °C
Medium temperature min./max.	0 ... 50 °C
Medium	Compressed air
Max. particle size	5 µm
Oil content of compressed air	0 ... 5 mg/m <sup>3</sup>
Nominal flow Qn	1400 l/min
Flow conductance C	5.2 l/(s*bar)
Protection class with connection	IP65
Duty cycle	100 %
Typ. switch-on time	12 ms
Typ. switch-off time	12 ms
Mounting screw	with hexagon socket
Mounting screw tightening torque	2 Nm
Weight	0.3 kg

## Technical data

Part No.		MO	Operational voltage DC	Voltage tolerance DC
5811222720			24 V	-10% / +10%
5811222710			24 V	-10% / +10%
5811220720			24 V	-10% / +10%
5811220710			24 V	-10% / +10%
5811223720			24 V	-10% / +10%
5811223710			24 V	-10% / +10%
5811221720			24 V	-10% / +10%
5811221710			24 V	-10% / +10%

Part No.	Power consumption DC	Pilot	Electrical connection Pilot valve	Throttle
5811222720	0.35 W	External	Plug M12 4-pin	-



Part No.	Power consumption DC	Pilot	Electrical connection Pilot valve	Throttle
5811222710	0.35 W	External	Plug M12 4-pin	-
5811220720	0.35 W	Internal	Plug M12 4-pin	-
5811220710	0.35 W	Internal	Plug M12 4-pin	-
5811223720	0.35 W	External	Plug M12 4-pin	with throttle
5811223710	0.35 W	External	Plug M12 4-pin	with throttle
5811221720	0.35 W	Internal	Plug M12 4-pin	with throttle
5811221710	0.35 W	Internal	Plug M12 4-pin	with throttle

Nominal flow  $Q_n$  at 6 bar and  $\Delta p = 1$  bar, MO = Manual override

## Technical information

The min. control pressure must be adhered to, since otherwise faulty switching and valve failure may result!

The pressure dew point must be at least 15 °C under ambient and medium temperature and may not exceed 3 °C .

The oil content of compressed air must remain constant during the life cycle.

Use only the approved oils from AVENTICS. Further information can be found in the "Technical information" document (available in the MediaCentre).

Switch-on power: 1 W for 40 ms

## Technical information

Housing	Polyamide fiber-glass reinforced
Seals	Acrylonitrile butadiene rubber

# Dimensions

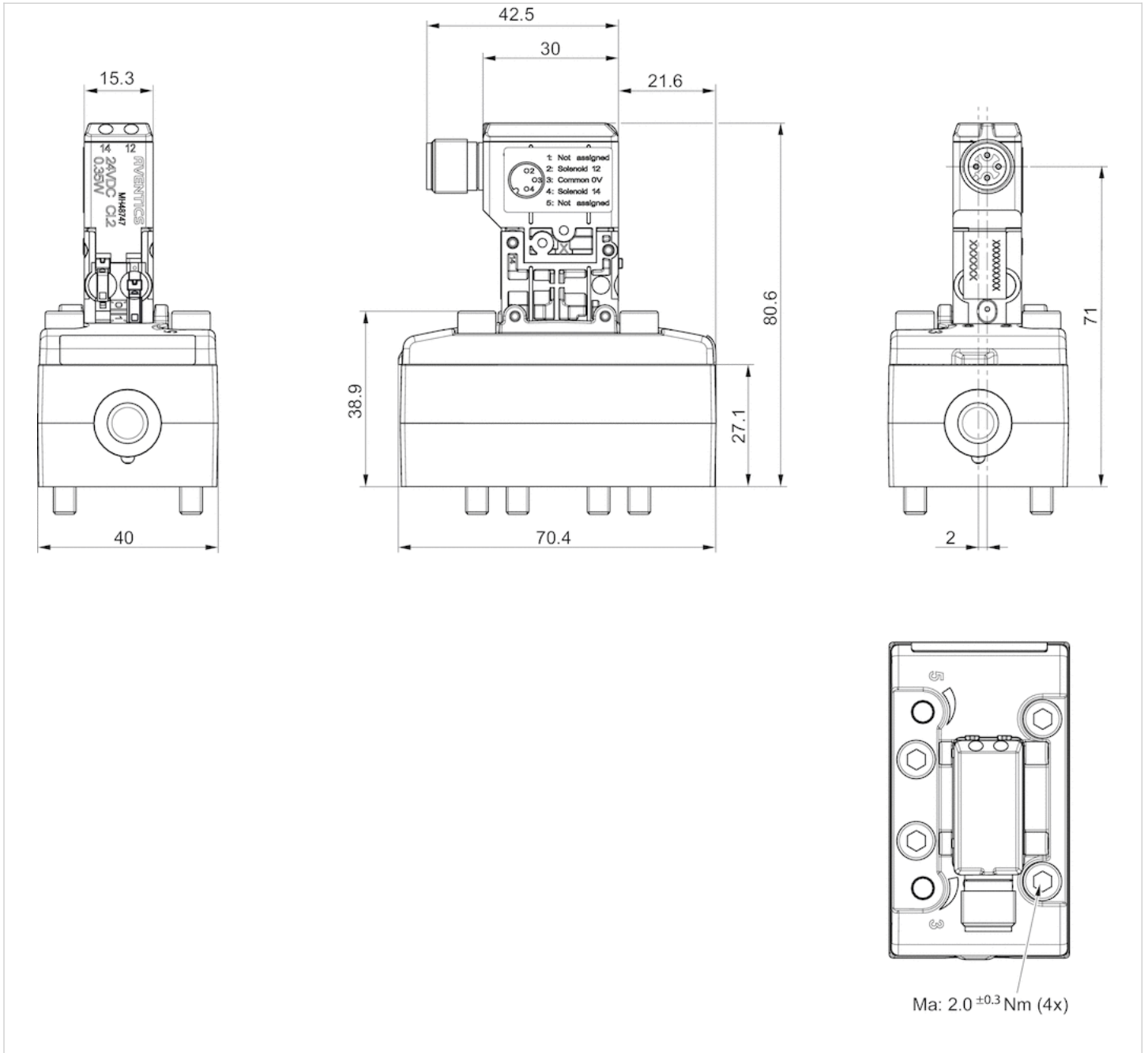

## Pin assignments

### Pin assignments

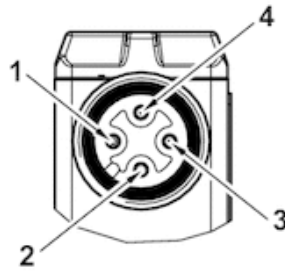

- 1) not assigned
- 2) Coil 12
- 3) 0 V DC
- 4) Coil 14















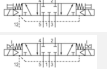

# 5/3-directional valve, Series 581, size 1

- ISO 5599-1
- ISO 1
- 5/3
- closed center
- $Q_n = 1100$  l/min
- Compressed air connection output Base plate ISO 5599-1
- Electrical connection Plug, M12, 4-pin
- Manual override with detent without detent

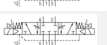

Type	Spool valve
Sealing principle	Soft sealing
Blocking principle	Single base plate principle
Connection type	Plate connection
Standards	ISO 5599-1, ISO 1
Working pressure min./max.	-0.95 ... 10 bar
Control pressure min./max.	3 ... 10 bar
Ambient temperature min./max.	0 ... 50 °C
Medium temperature min./max.	0 ... 50 °C
Medium	Compressed air
Max. particle size	5 µm
Oil content of compressed air	0 ... 5 mg/m <sup>3</sup>
Nominal flow $Q_n$	1100 l/min
Flow conductance C	4.3 l/(s*bar)
Protection class with connection	IP65
Duty cycle	100 %
Typ. switch-on time	12 ms
Typ. switch-off time	25 ms
Mounting screw	with hexagon socket
Mounting screw tightening torque	2 Nm
Weight	0.18 kg

## Technical data

Part No.		MO		Operational voltage DC	Voltage tolerance DC
5811422720			closed center	24 V	-10% / +10%
5811422710			closed center	24 V	-10% / +10%
5811420720			closed center	24 V	-10% / +10%
5811420710			closed center	24 V	-10% / +10%
5811423720			closed center	24 V	-10% / +10%
5811423710			closed center	24 V	-10% / +10%
5811421720			closed center	24 V	-10% / +10%
5811421710			closed center	24 V	-10% / +10%

Part No.	Power consumption DC	Pilot	Electrical connection Pilot valve	Throttle
5811422720	0.35 W	External	Plug M12 4-pin	-

Part No.	Power consumption DC	Pilot	Electrical connection Pilot valve	Throttle
5811422710	0.35 W	External	Plug M12 4-pin	-
5811420720	0.35 W	Internal	Plug M12 4-pin	-
5811420710	0.35 W	Internal	Plug M12 4-pin	-
5811423720	0.35 W	External	Plug M12 4-pin	with throttle
5811423710	0.35 W	External	Plug M12 4-pin	with throttle
5811421720	0.35 W	Internal	Plug M12 4-pin	with throttle
5811421710	0.35 W	Internal	Plug M12 4-pin	with throttle

Nominal flow  $Q_n$  at 6 bar and  $\Delta p = 1$  bar, MO = Manual override

## Technical information

The min. control pressure must be adhered to, since otherwise faulty switching and valve failure may result!

The pressure dew point must be at least 15 °C under ambient and medium temperature and may not exceed 3 °C .

The oil content of compressed air must remain constant during the life cycle.

Use only the approved oils from AVENTICS. Further information can be found in the "Technical information" document (available in the MediaCentre).

Switch-on power: 1 W for 40 ms

## Technical information

Housing	Polyamide fiber-glass reinforced
Seals	Acrylonitrile butadiene rubber

# Dimensions

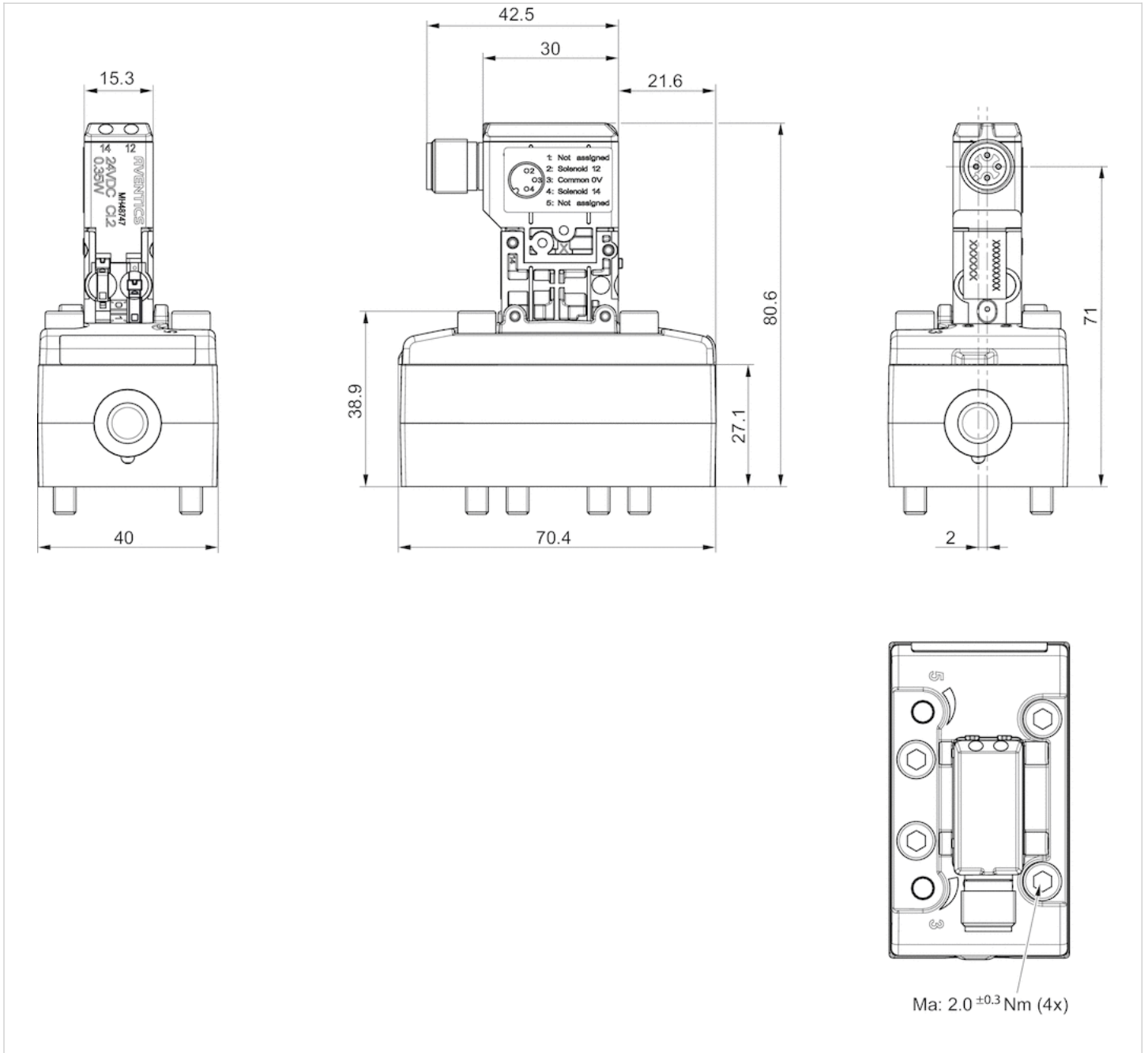

## Pin assignments

### Pin assignments

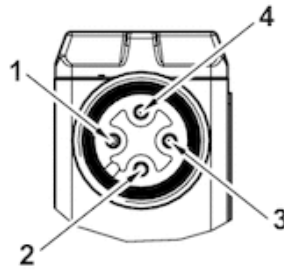

- 1) not assigned
- 2) Coil 12
- 3) 0 V DC
- 4) Coil 14

















# 5/3-directional valve, Series 581, size 1

- ISO 5599-1
- ISO 1
- 5/3
- exhausted center
- Qn = 1100 l/min
- Compressed air connection output Base plate ISO 5599-1
- Electrical connection Plug, M12, 4-pin
- Manual override with detent without detent



Type	Spool valve
Sealing principle	Soft sealing
Blocking principle	Single base plate principle
Connection type	Plate connection
Standards	ISO 5599-1, ISO 1
Working pressure min./max.	-0.95 ... 10 bar
Control pressure min./max.	3 ... 10 bar
Ambient temperature min./max.	0 ... 50 °C
Medium temperature min./max.	0 ... 50 °C
Medium	Compressed air
Max. particle size	5 µm
Oil content of compressed air	0 ... 5 mg/m <sup>3</sup>
Nominal flow Qn	1100 l/min
Flow conductance C	4.3 l/(s*bar)
Protection class with connection	IP65
Duty cycle	100 %
Typ. switch-on time	15 ms
Typ. switch-off time	25 ms
Mounting screw	with hexagon socket
Mounting screw tightening torque	2 Nm
Weight	0.3 kg

## Technical data

Part No.		MO		Operational voltage DC
5811522720			exhausted center	24 V
5811522710			exhausted center	24 V
5811520720			exhausted center	24 V
5811520710			exhausted center	24 V
5811523720			exhausted center	24 V
5811523710			exhausted center	24 V
5811521720			exhausted center	24 V
5811521710			exhausted center	24 V

Part No.	Voltage tolerance DC	Power consumption DC	Pilot	Electrical connection Pilot valve
5811522720	-10% / +10%	0.35 W	External	Plug M12 4-pin



Part No.	Voltage tolerance DC	Power consumption DC	Pilot	Electrical connection Pilot valve
5811522710	-10% / +10%	0.35 W	External	Plug M12 4-pin
5811520720	-10% / +10%	0.35 W	Internal	Plug M12 4-pin
5811520710	-10% / +10%	0.35 W	Internal	Plug M12 4-pin
5811523720	-10% / +10%	0.35 W	External	Plug M12 4-pin
5811523710	-10% / +10%	0.35 W	External	Plug M12 4-pin
5811521720	-10% / +10%	0.35 W	Internal	Plug M12 4-pin
5811521710	-10% / +10%	0.35 W	Internal	Plug M12 4-pin

Part No.	Throttle
5811522720	-
5811522710	-
5811520720	-
5811520710	-
5811523720	with throttle
5811523710	with throttle
5811521720	with throttle
5811521710	with throttle

Nominal flow  $Q_n$  at 6 bar and  $\Delta p = 1$  bar, MO = Manual override

## Technical information

The min. control pressure must be adhered to, since otherwise faulty switching and valve failure may result!

The pressure dew point must be at least 15 °C under ambient and medium temperature and may not exceed 3 °C .

The oil content of compressed air must remain constant during the life cycle.

Use only the approved oils from AVENTICS. Further information can be found in the "Technical information" document (available in the MediaCentre).

Switch-on power: 1 W for 40 ms

## Technical information

Housing	Polyamide fiber-glass reinforced
Seals	Acrylonitrile butadiene rubber

# Dimensions

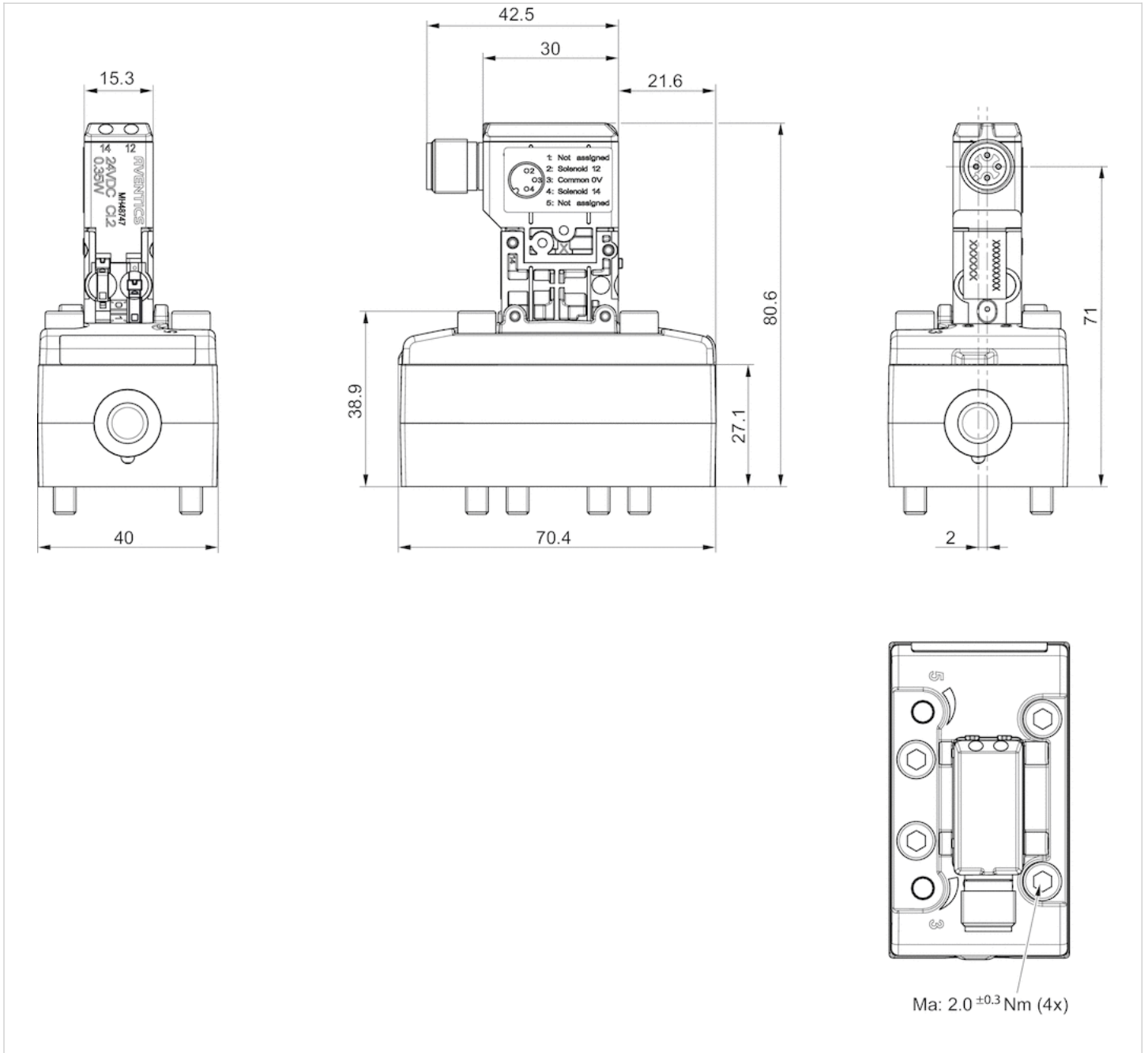

## Pin assignments

### Pin assignments

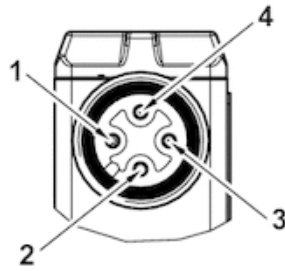

- 1) not assigned
- 2) Coil 12
- 3) 0 V DC
- 4) Coil 14

















# 5/3-directional valve, Series 581, size 1

- ISO 5599-1
- ISO 1
- 5/3
- pressurized center
- Qn = 1100 l/min
- Compressed air connection output Base plate ISO 5599-1
- Electrical connection Plug, M12, 4-pin
- Manual override with detent without detent



Type	Spool valve
Sealing principle	Soft sealing
Blocking principle	Single base plate principle
Connection type	Plate connection
Standards	ISO 5599-1, ISO 1
Working pressure min./max.	-0.95 ... 10 bar
Control pressure min./max.	3 ... 10 bar
Ambient temperature min./max.	0 ... 50 °C
Medium temperature min./max.	0 ... 50 °C
Medium	Compressed air
Max. particle size	5 µm
Oil content of compressed air	0 ... 5 mg/m <sup>3</sup>
Nominal flow Qn	1100 l/min
Flow conductance C	4.3 l/(s*bar)
Protection class with connection	IP65
Duty cycle	100 %
Typ. switch-on time	12 ms
Typ. switch-off time	25 ms
Mounting screw	with hexagon socket
Mounting screw tightening torque	2 Nm
Weight	0.18 kg

## Technical data

Part No.		MO		Operational voltage DC
5811722720			pressurized center	24 V
5811722710			pressurized center	24 V
5811720720			pressurized center	24 V
5811720710			pressurized center	24 V
5811723720			pressurized center	24 V
5811723710			pressurized center	24 V
5811721720			pressurized center	24 V
5811721710			pressurized center	24 V

Part No.	Voltage tolerance DC	Power consumption DC	Pilot	Electrical connection Pilot valve
5811722720	-10% / +10%	0.35 W	External	Plug M12 4-pin

Part No.	Voltage tolerance DC	Power consumption DC	Pilot	Electrical connection Pilot valve
5811722710	-10% / +10%	0.35 W	External	Plug M12 4-pin
5811720720	-10% / +10%	0.35 W	Internal	Plug M12 4-pin
5811720710	-10% / +10%	0.35 W	Internal	Plug M12 4-pin
5811723720	-10% / +10%	0.35 W	External	Plug M12 4-pin
5811723710	-10% / +10%	0.35 W	External	Plug M12 4-pin
5811721720	-10% / +10%	0.35 W	Internal	Plug M12 4-pin
5811721710	-10% / +10%	0.35 W	Internal	Plug M12 4-pin

Part No.	Throttle
5811722720	-
5811722710	-
5811720720	-
5811720710	-
5811723720	with throttle
5811723710	with throttle
5811721720	with throttle
5811721710	with throttle

Nominal flow Qn at 6 bar and  $\Delta p = 1$  bar, MO = Manual override

## Technical information

The min. control pressure must be adhered to, since otherwise faulty switching and valve failure may result!

The pressure dew point must be at least 15 °C under ambient and medium temperature and may not exceed 3 °C .

The oil content of compressed air must remain constant during the life cycle.

Use only the approved oils from AVENTICS. Further information can be found in the "Technical information" document (available in the MediaCentre).

Switch-on power: 1 W for 40 ms

## Technical information

Housing	Polyamide fiber-glass reinforced
Seals	Acrylonitrile butadiene rubber

# Dimensions

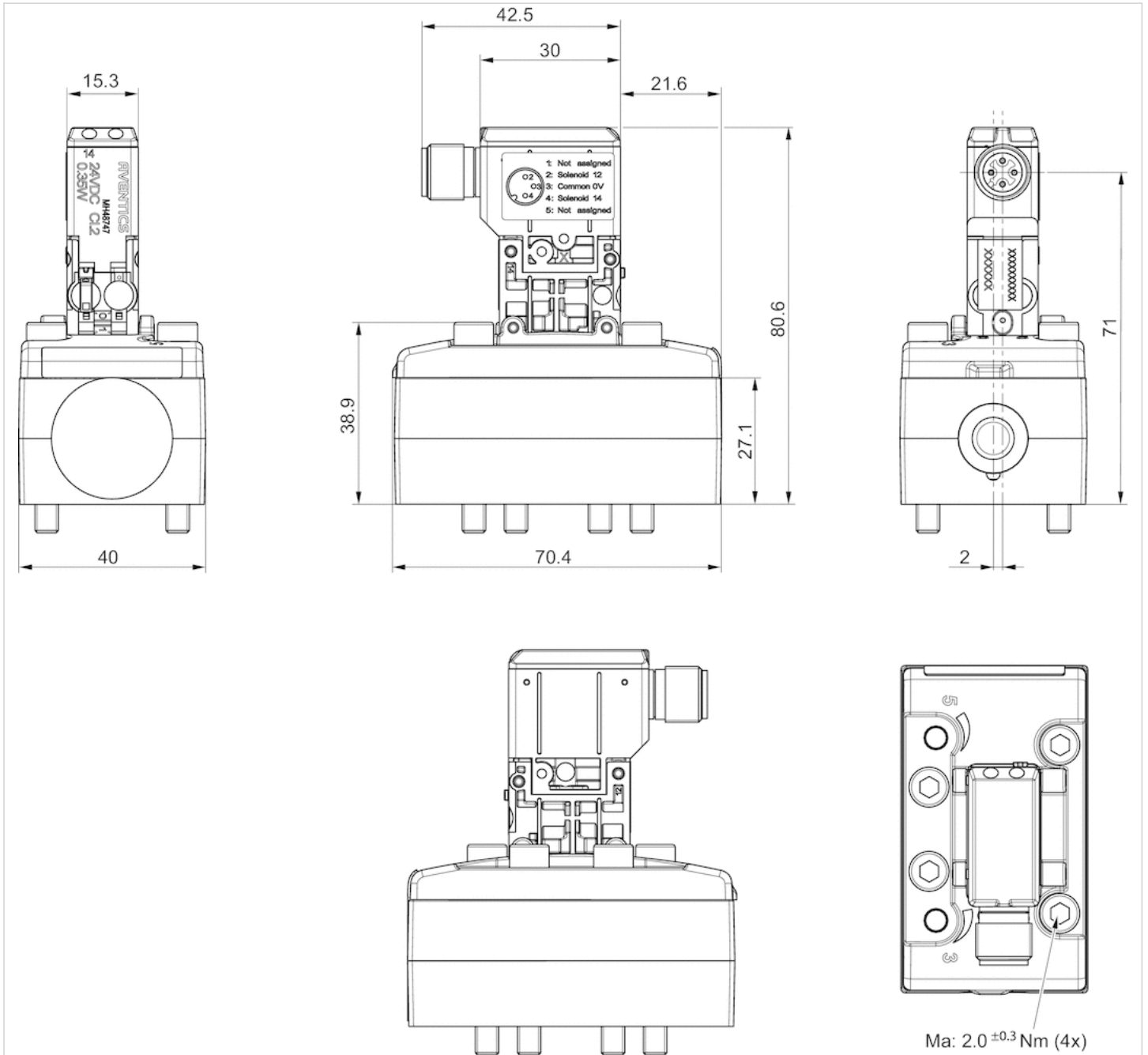

## Pin assignments

### Pin assignments

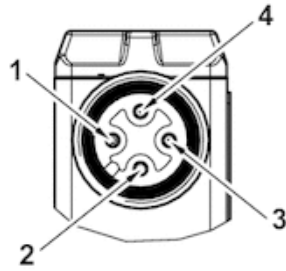

- 1) not assigned
- 2) Coil 12
- 3) 0 V DC
- 4) Coil 14

# 5/2-directional valve, Series 581, size 1

- ISO 5599-1
- ISO 1
- 5/2
- Basic valve for CNOMO pilot valve
- With spring return
- single solenoid
- $Q_n = 1400 \text{ l/min}$
- Compressed air connection output Base plate ISO 5599-1



Type	Spool valve
basic valve with electrical connector	Basic valve without pilot valve
Pilot	External Internal
Sealing principle	Soft sealing
Blocking principle	Single base plate principle
Connection type	Plate connection
Standards	ISO 5599-1, ISO 1
Working pressure min./max.	-0,95 ... 16 bar
Control pressure min./max.	3 ... 16 bar
Ambient temperature min./max.	-20 ... 70 °C
Medium temperature min./max.	-20 ... 70 °C
Medium	Compressed air
Max. particle size	50 $\mu\text{m}$
Oil content of compressed air	0 ... 5 $\text{mg/m}^3$
Nominal flow $Q_n$	1400 l/min
Flow conductance C	5,2 $\text{l/(s*bar)}$
Protection class with connection	IP65
Duty cycle	100 %
Mounting screw	with hexagon socket
Mounting screw tightening torque	2 Nm
Weight	0,21 kg

## Technical data

Part No.		Throttle
5811180000		-
5811181000		with throttle

Nominal flow  $Q_n$  at 6 bar and  $\Delta p = 1 \text{ bar}$ , The pilot can be set by turning the seal under the valve cover by 180°. For internal pilot the working pressure min/max is the same as the control pressure min/max.

## Technical information



The min. control pressure must be adhered to, since otherwise faulty switching and valve failure may result!  
The pressure dew point must be at least 15 °C under ambient and medium temperature and may not exceed 3 °C .  
The oil content of compressed air must remain constant during the life cycle.  
Use only the approved oils from AVENTICS. Further information can be found in the “Technical information” document (available in the MediaCentre).

## Technical information

Housing	Aluminum
Seals	Acrylonitrile butadiene rubber

## Dimensions

### Dimensions

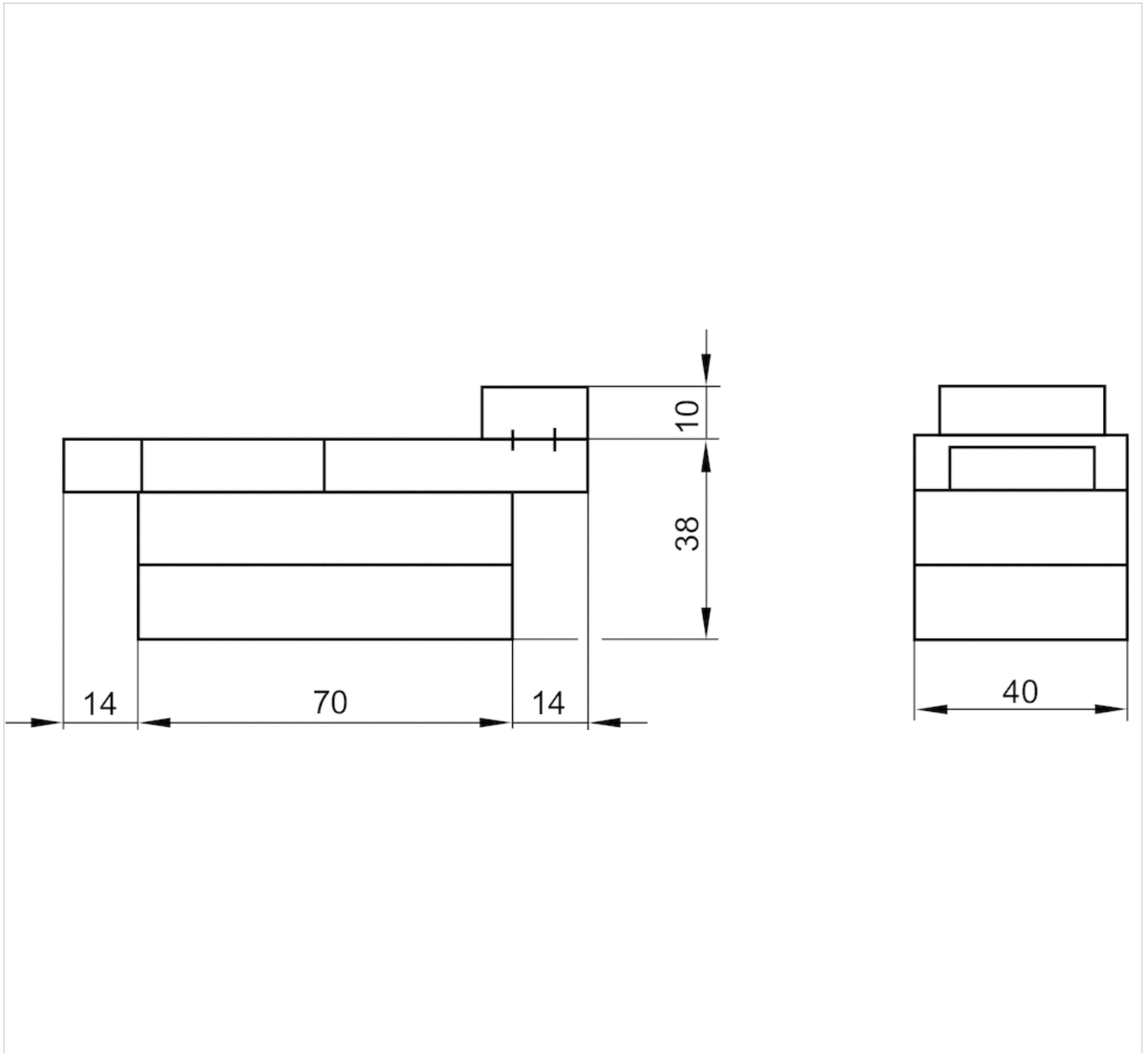



# 5/2-directional valve, Series 581, size 1

- ISO 5599-1
- ISO 1
- 5/2
- Basic valve for CNOMO pilot valve
- double solenoid
- $Q_n = 1400 \text{ l/min}$
- Compressed air connection output Base plate ISO 5599-1



Type	Spool valve
basic valve with electrical connector	Basic valve without pilot valve
Pilot	External Internal
Sealing principle	Soft sealing
Blocking principle	Single base plate principle
Connection type	Plate connection
Standards	ISO 5599-1, ISO 1
Working pressure min./max.	-0,95 ... 16 bar
Control pressure min./max.	1,5 ... 16 bar
Ambient temperature min./max.	-20 ... 70 °C
Medium temperature min./max.	-20 ... 70 °C
Medium	Compressed air
Max. particle size	50 $\mu\text{m}$
Oil content of compressed air	0 ... 5 $\text{mg/m}^3$
Nominal flow $Q_n$	1400 l/min
Flow conductance C	5,2 $\text{l}/(\text{s}^*\text{bar})$
Protection class with connection	IP65
Duty cycle	100 %
Mounting screw	with hexagon socket
Mounting screw tightening torque	2 Nm
Weight	0,21 kg

## Technical data

Part No.		Throttle
5811280000		-
5811281000		with throttle

Nominal flow  $Q_n$  at 6 bar and  $\Delta p = 1 \text{ bar}$ , The pilot can be set by turning the seal under the valve cover by 180°. For internal pilot the working pressure min/max is the same as the control pressure min/max.

## Technical information

The min. control pressure must be adhered to, since otherwise faulty switching and valve failure may result!  
 The pressure dew point must be at least 15 °C under ambient and medium temperature and may not exceed 3 °C .  
 The oil content of compressed air must remain constant during the life cycle.  
 Use only the approved oils from AVENTICS. Further information can be found in the "Technical information" document (available in the MediaCentre).

\*) Note: ATEX variants can be manufactured by combining the basic valve without a coil with a CNOMO pilot valve, series DO30, and an ATEX coil. ATEX ID: see ATEX coils catalog sheet.

## Technical information

Housing	Aluminum
Seals	Acrylonitrile butadiene rubber

## Dimensions

### Dimensions

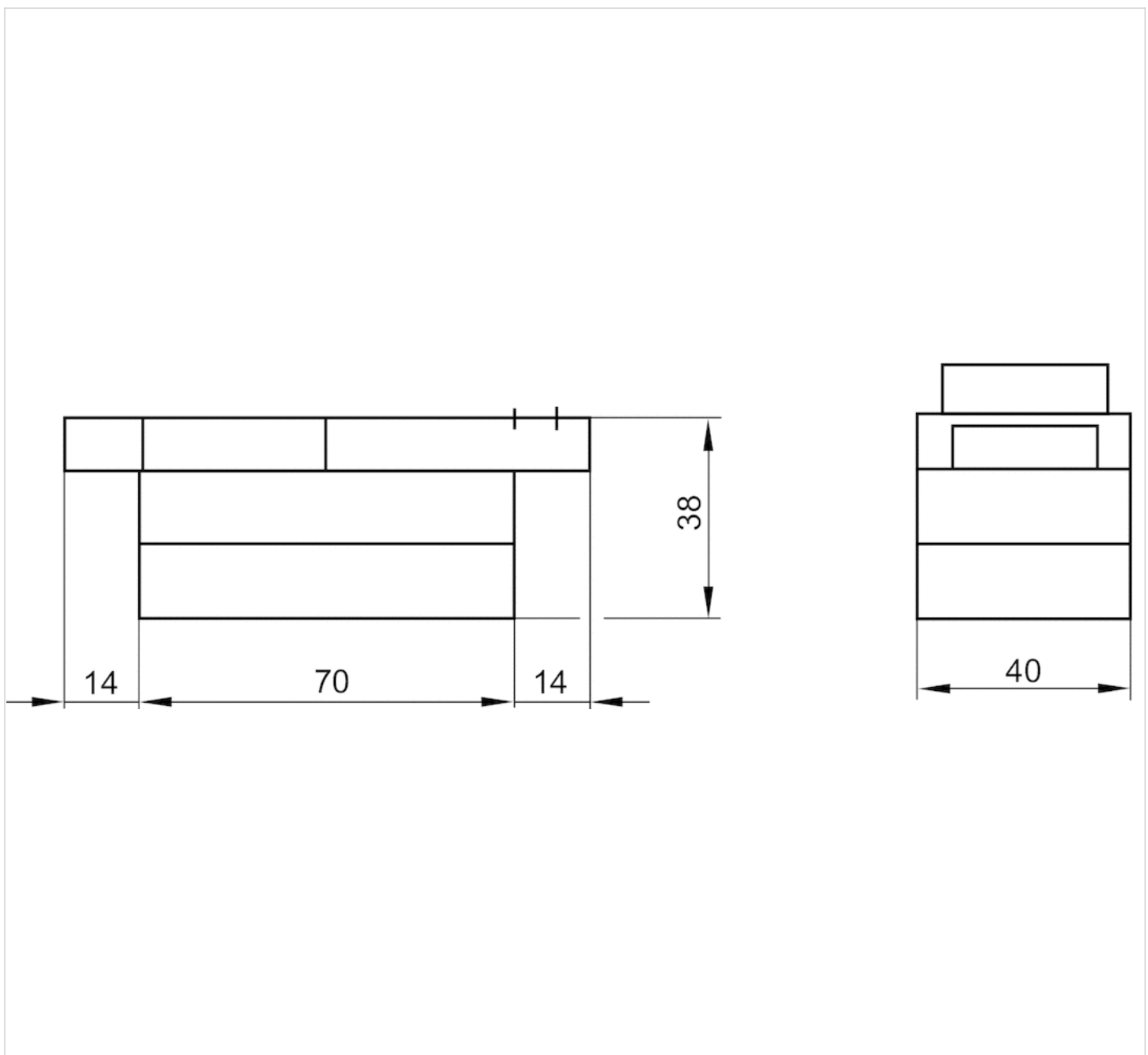



# 5/2-directional valve, Series 581, size 1

- ISO 5599-1
- 5/2
- Basic valve for CNOMO pilot valve
- Air return with differential piston
- $Q_n = 1400$  l/min
- Compressed air connection output Base plate ISO 5599-1



Type	Spool valve
basic valve with electrical connector	Basic valve without pilot valve
Pilot	External Internal
Sealing principle	Soft sealing
Blocking principle	Single base plate principle
Connection type	Plate connection
Standards	ISO 5599-1
Working pressure min./max.	-0,95 ... 16 bar
Control pressure min./max.	1,3 ... 16 bar
Ambient temperature min./max.	-20 ... 70 °C
Medium temperature min./max.	-20 ... 70 °C
Medium	Compressed air
Max. particle size	50 µm
Oil content of compressed air	0 ... 5 mg/m <sup>3</sup>
Nominal flow $Q_n$	1400 l/min
Flow conductance C	5,2 l/(s*bar)
Protection class with connection	IP65
Duty cycle	100 %
Mounting screw	with hexagon socket
Mounting screw tightening torque	2 Nm
Weight	0,21 kg

## Technical data

Part No.		Throttle
5811680000		-
5811681000		with throttle

Differential piston, signal 14 has priority, The minimum pilot pressure at port 14 is dependent on the pressure in port 1., The pilot can be set by turning the seal under the valve cover by 180°. For internal pilot the working pressure min/max is the same as the control pressure min/max.

## Technical information

The min. control pressure must be adhered to, since otherwise faulty switching and valve failure may result!  
 The pressure dew point must be at least 15 °C under ambient and medium temperature and may not exceed 3 °C .  
 The oil content of compressed air must remain constant during the life cycle.  
 Use only the approved oils from AVENTICS. Further information can be found in the "Technical information" document (available in the MediaCentre).

\* Note: ATEX version can be produced by combining the basic valve without coil with a series DO30 CNOMO pilot valve and an ATEX coil.  
 ATEX ID: see ATEX coils catalog page.

## Technical information

Housing	Aluminum
Seals	Acrylonitrile butadiene rubber

## Dimensions

### Dimensions

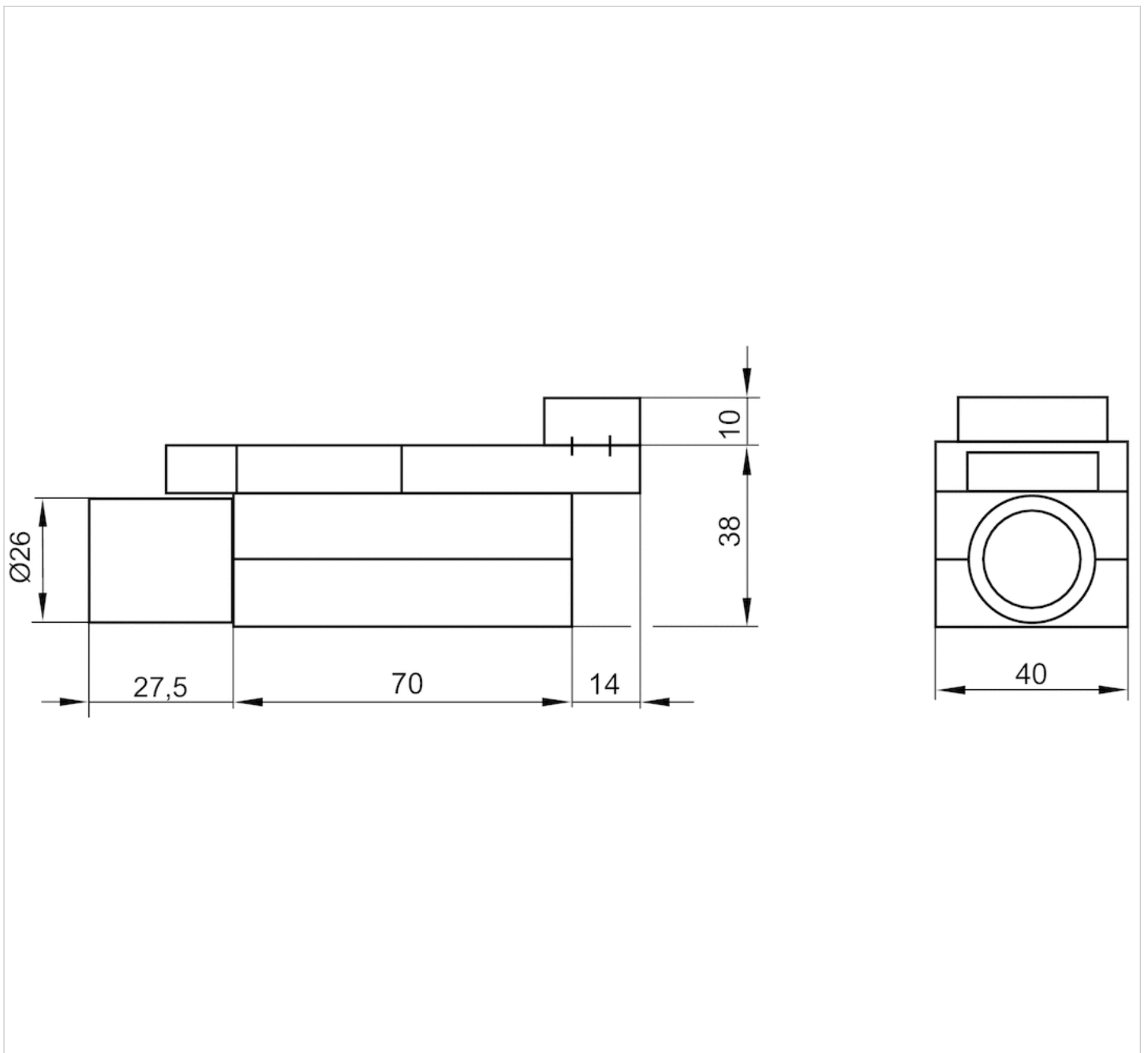

# 5/3-directional valve, Series 581, size 1

- ISO 5599-1
- ISO 1
- 5/3
- Basic valve for CNOMO pilot valve
- closed center exhausted center pressurized center
- $Q_n = 1100 \text{ l/min}$
- Compressed air connection output Base plate ISO 5599-1



Type	Spool valve
basic valve with electrical connector	Basic valve without pilot valve
Pilot	External Internal
Sealing principle	Soft sealing
Blocking principle	Single base plate principle
Connection type	Plate connection
Standards	ISO 5599-1, ISO 1
Working pressure min./max.	-0,95 ... 16 bar
Control pressure min./max.	3 ... 16 bar
Ambient temperature min./max.	-20 ... 70 °C
Medium temperature min./max.	-20 ... 70 °C
Medium	Compressed air
Max. particle size	50 µm
Oil content of compressed air	0 ... 5 mg/m <sup>3</sup>
Nominal flow $Q_n$	1100 l/min
Flow conductance C	4,3 l/(s*bar)
Protection class with connection	IP65
Duty cycle	100 %
Mounting screw	with hexagon socket
Mounting screw tightening torque	2 Nm
Weight	0,21 kg

## Technical data

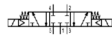
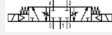
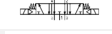
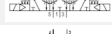
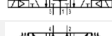
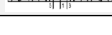
Part No.			Throttle
5811480000		closed center	-
5811481000		closed center	with throttle
5811580000		exhausted center	-
5811581000		exhausted center	with throttle
5811780000		pressurized center	-
5811781000		pressurized center	with throttle

Nominal flow  $Q_n$  at 6 bar and  $\Delta p = 1 \text{ bar}$ , The pilot can be set by turning the seal under the valve cover by 180°. For internal pilot the working pressure min/max is the same as the control pressure min/max.

## Technical information

The min. control pressure must be adhered to, since otherwise faulty switching and valve failure may result!  
 The pressure dew point must be at least 15 °C under ambient and medium temperature and may not exceed 3 °C .  
 The oil content of compressed air must remain constant during the life cycle.  
 Use only the approved oils from AVENTICS. Further information can be found in the “Technical information” document (available in the MediaCentre).

\*) Note: ATEX variants can be manufactured by combining the basic valve without a coil with a CNOMO pilot valve, series DO30, and an ATEX coil. ATEX ID: see ATEX coils catalog sheet.

## Technical information

Housing	Aluminum
Seals	Acrylonitrile butadiene rubber



## Dimensions

### Dimensions

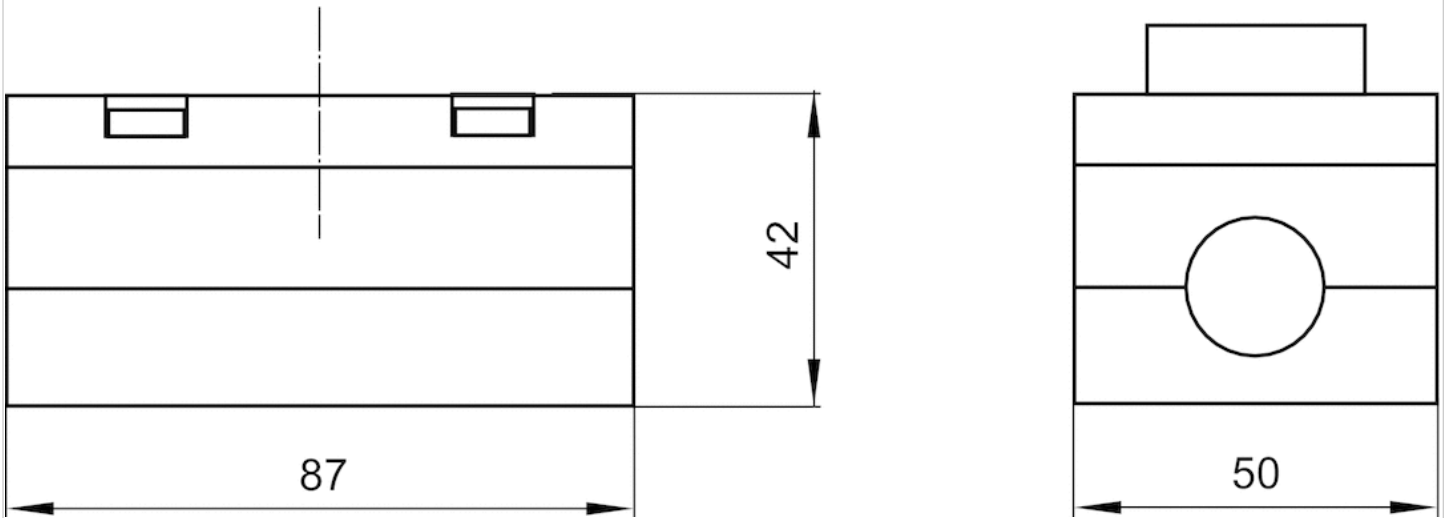

# 5/2-directional valve, Series 581, size 1

- ISO 5599-1
- ISO 1
- 5/2
- Basic valve for CNOMO pilot valve
- With spring return
- single solenoid
- $Q_n = 1400 \text{ l/min}$
- Compressed air connection output Base plate ISO 5599-1

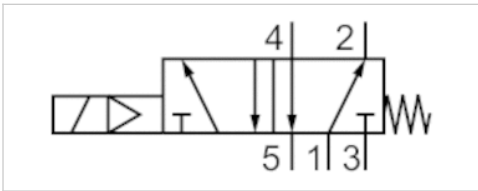

Type	Spool valve
basic valve with electrical connector	Basic valve without pilot valve
Pilot	External Internal
Sealing principle	Soft sealing
Blocking principle	Single base plate principle
Connection type	Plate connection
Standards	ISO 5599-1, ISO 1
Working pressure min./max.	-0,95 ... 10 bar
Control pressure min./max.	3 ... 10 bar
Ambient temperature min./max.	-15 ... 50 °C
Medium temperature min./max.	-15 ... 50 °C
Medium	Compressed air
Max. particle size	50 µm
Oil content of compressed air	0 ... 5 mg/m <sup>3</sup>
Nominal flow $Q_n$	1400 l/min
Flow conductance C	5,2 l/(s*bar)
Protection class with connection	IP65
Duty cycle	100 %
Mounting screw	with hexagon socket
Mounting screw tightening torque	2 Nm
Weight	0,21 kg

## Technical data

Part No.

5811180080

Nominal flow  $Q_n$  at 6 bar and  $\Delta p = 1 \text{ bar}$ , The pilot can be set by turning the seal under the valve cover by 180°. For internal pilot the working pressure min/max is the same as the control pressure min/max.

## Technical information

The min. control pressure must be adhered to, since otherwise faulty switching and valve failure may result!

The pressure dew point must be at least 15 °C under ambient and medium temperature and may not exceed 3 °C .

The oil content of compressed air must remain constant during the life cycle.

Use only the approved oils from AVENTICS. Further information can be found in the "Technical information" document (available in the MediaCentre).

## Technical information

Housing	Polyamide
Seals	Acrylonitrile butadiene rubber

## Dimensions

### Dimensions

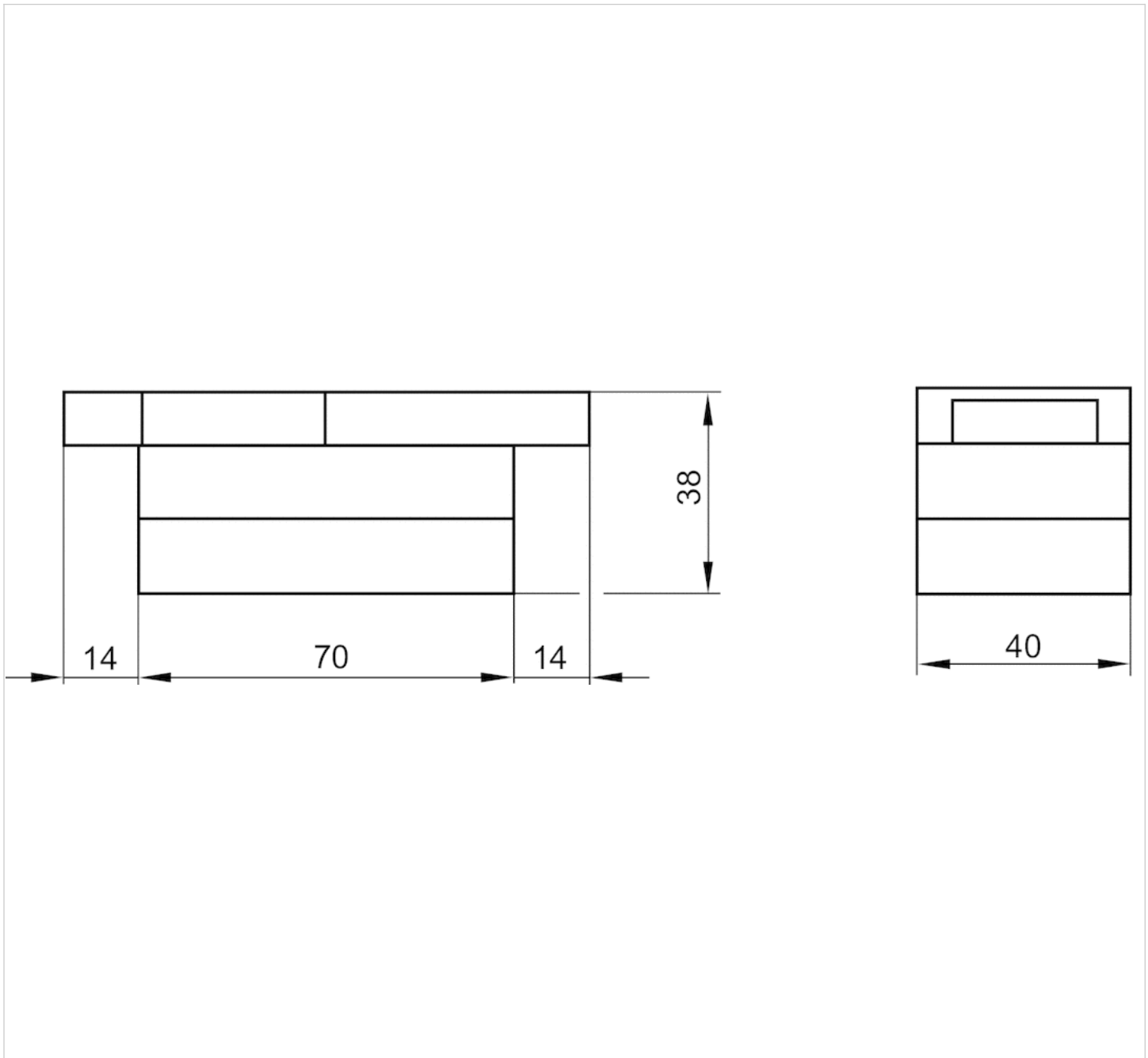

# 5/2-directional valve, Series 581, size 1

- ISO 5599-1
- ISO 1
- 5/2
- Basic valve for CNOMO pilot valve
- double solenoid
- $Q_n = 1400 \text{ l/min}$
- Compressed air connection output Base plate ISO 5599-1

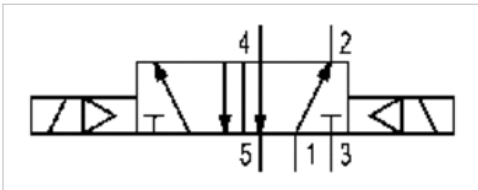

Type	Spool valve
basic valve with electrical connector	Basic valve without pilot valve
Pilot	External Internal
Sealing principle	Soft sealing
Blocking principle	Single base plate principle
Connection type	Plate connection
Standards	ISO 5599-1, ISO 1
Working pressure min./max.	-0,95 ... 10 bar
Control pressure min./max.	1,5 ... 10 bar
Ambient temperature min./max.	-15 ... 50 °C
Medium temperature min./max.	-15 ... 50 °C
Medium	Compressed air
Max. particle size	50 µm
Oil content of compressed air	0 ... 5 mg/m <sup>3</sup>
Nominal flow $Q_n$	1400 l/min
Flow conductance C	5,2 l/(s*bar)
Protection class with connection	IP65
Duty cycle	100 %
Mounting screw	with hexagon socket
Mounting screw tightening torque	2 Nm
Weight	0,21 kg

## Technical data

Part No.

5811280080

Nominal flow  $Q_n$  at 6 bar and  $\Delta p = 1 \text{ bar}$ , The pilot can be set by turning the seal under the valve cover by 180°. For internal pilot the working pressure min/max is the same as the control pressure min/max.

## Technical information

The min. control pressure must be adhered to, since otherwise faulty switching and valve failure may result!

The pressure dew point must be at least 15 °C under ambient and medium temperature and may not exceed 3 °C .

The oil content of compressed air must remain constant during the life cycle.

Use only the approved oils from AVENTICS. Further information can be found in the "Technical information" document (available in the MediaCentre).

## Technical information

Housing	Polyamide
Seals	Acrylonitrile butadiene rubber

## Dimensions

### Dimensions

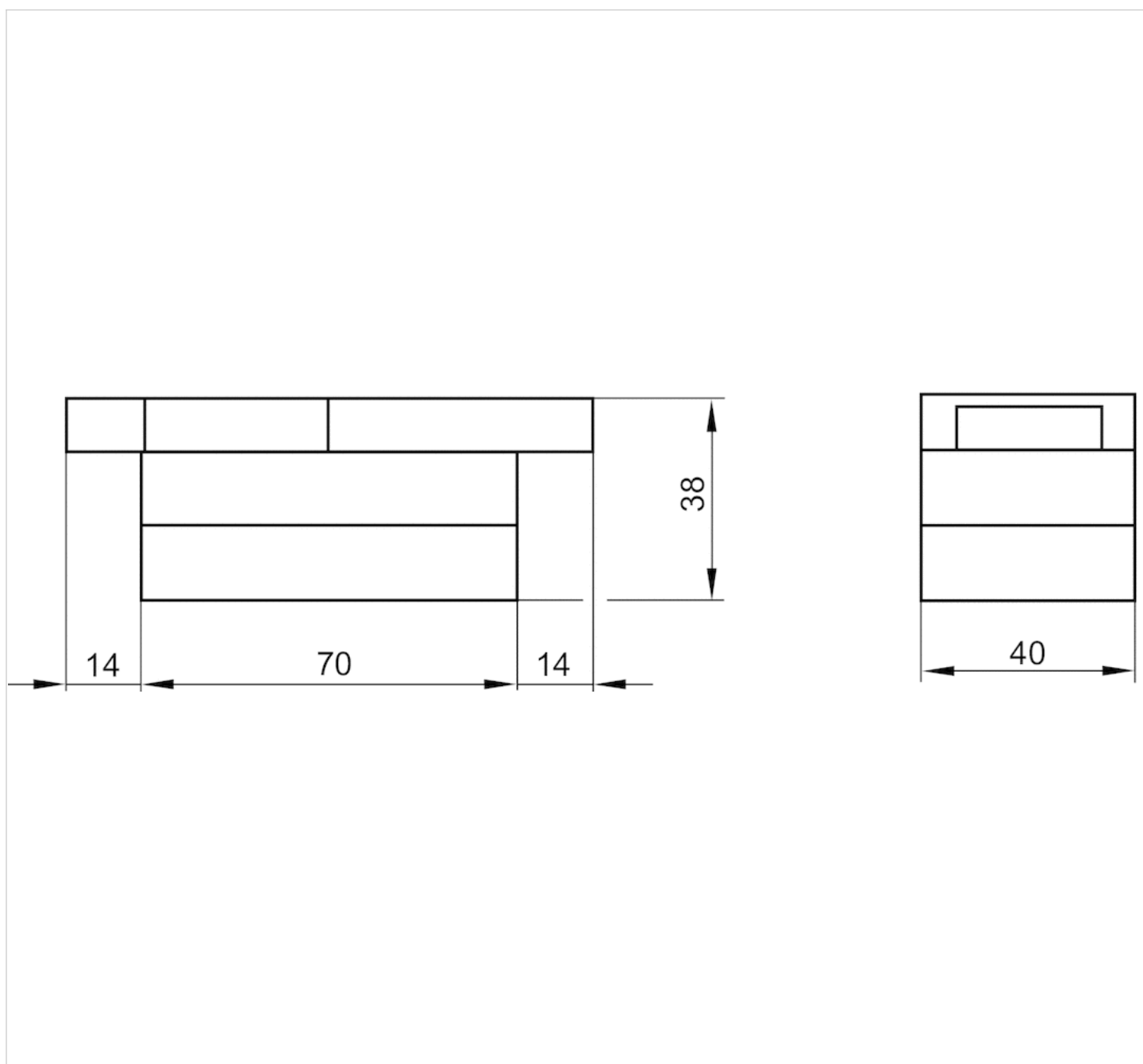

# 5/2-directional valve, Series 581, size 1

- ISO 5599-1
- 5/2
- Basic valve for CNOMO pilot valve
- Air return with differential piston
- $Q_n = 1400$  l/min
- Compressed air connection output Base plate ISO 5599-1

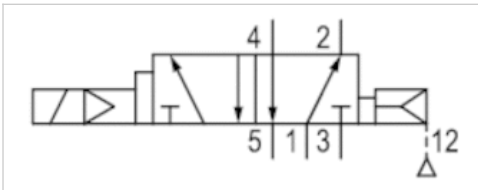

Type	Spool valve
basic valve with electrical connector	Basic valve without pilot valve
Pilot	External Internal
Sealing principle	Soft sealing
Blocking principle	Single base plate principle
Connection type	Plate connection
Standards	ISO 5599-1
Working pressure min./max.	-0,95 ... 10 bar
Control pressure min./max.	1,3 ... 10 bar
Ambient temperature min./max.	-15 ... 50 °C
Medium temperature min./max.	-15 ... 50 °C
Medium	Compressed air
Max. particle size	50 µm
Oil content of compressed air	0 ... 5 mg/m <sup>3</sup>
Nominal flow $Q_n$	1400 l/min
Flow conductance C	5,2 l/(s*bar)
Protection class with connection	IP65
Duty cycle	100 %
Mounting screw	with hexagon socket
Mounting screw tightening torque	2 Nm
Weight	0,21 kg

## Technical data

Part No.

5811680080

Differential piston, signal 14 has priority, The minimum pilot pressure at port 14 is dependent on the pressure in port 1., The pilot can be set by turning the seal under the valve cover by 180°. For internal pilot the working pressure min/max is the same as the control pressure min/max.

## Technical information

The min. control pressure must be adhered to, since otherwise faulty switching and valve failure may result!

The pressure dew point must be at least 15 °C under ambient and medium temperature and may not exceed 3 °C .

The oil content of compressed air must remain constant during the life cycle.

Use only the approved oils from AVENTICS. Further information can be found in the "Technical information" document (available in the MediaCentre).

## Technical information

Housing	Polyamide
Seals	Acrylonitrile butadiene rubber

## Dimensions

## Dimensions

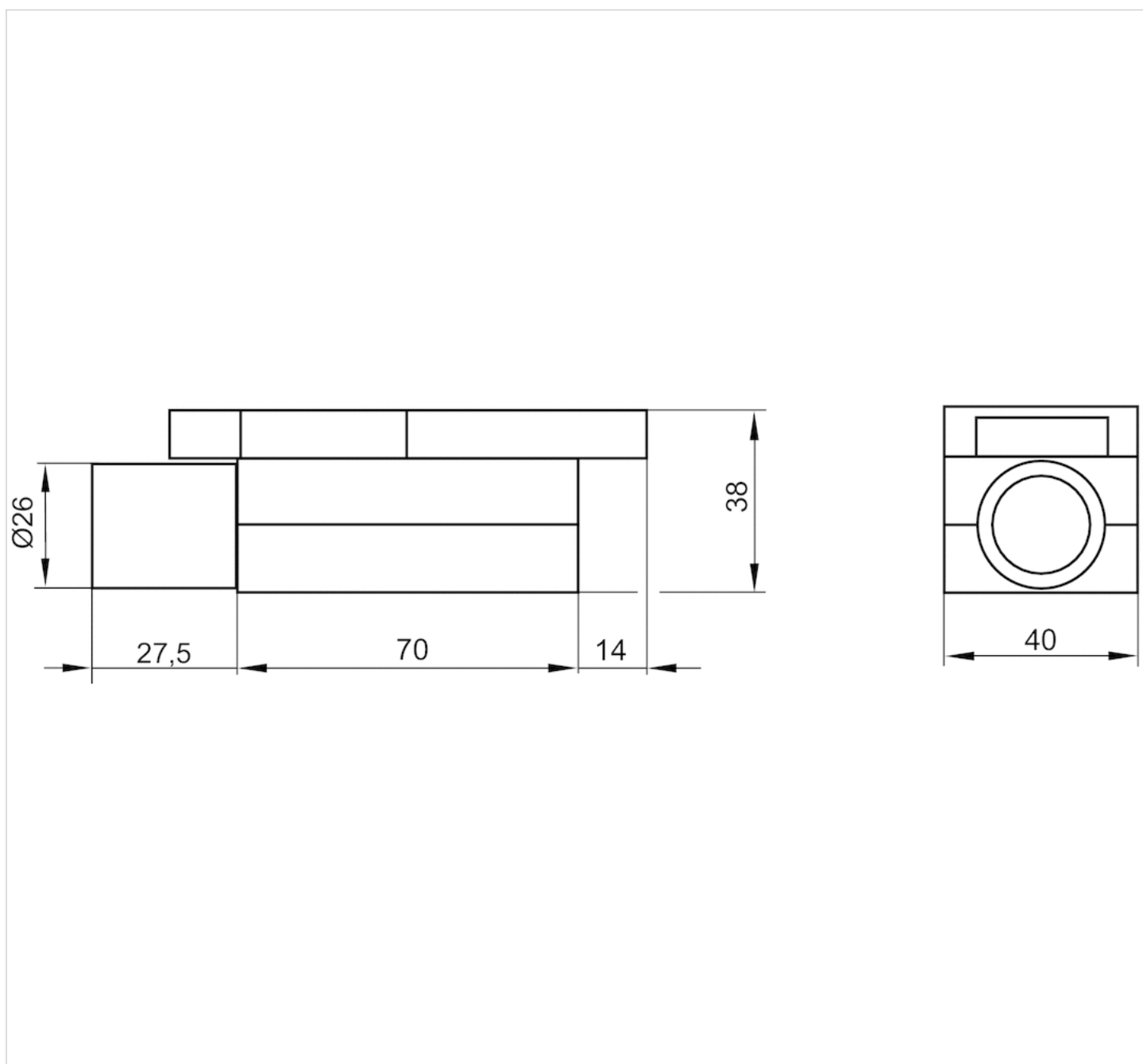

# 5/3-directional valve, Series 581, size 1

- ISO 5599-1
- ISO 1
- 5/3
- Basic valve for CNOMO pilot valve
- With air spring return
- double solenoid
- closed center exhausted center pressurized center
- Qn = 1100 l/min
- Compressed air connection output Base plate ISO 5599-1



Type	basic valve with electrical connector	Spool valve
Pilot		Basic valve without pilot valve
Sealing principle		External Internal
Blocking principle		Soft sealing
Connection type		Single base plate principle
Standards		Plate connection
Working pressure min./max.		ISO 5599-1, ISO 1
Control pressure min./max.		-0,95 ... 10 bar
Ambient temperature min./max.		3 ... 10 bar
Medium temperature min./max.		-15 ... 50 °C
Medium		-15 ... 50 °C
Max. particle size		Compressed air
Oil content of compressed air		50 µm
Nominal flow Qn		0 ... 5 mg/m <sup>3</sup>
Flow conductance C		1100 l/min
Protection class with connection		4,3 l/(s*bar)
Duty cycle		IP65
Mounting screw		100 %
Mounting screw tightening torque		with hexagon socket
Weight		2 Nm
		0,21 kg

## Technical data

Part No.		
5811480080		closed center
5811580080		exhausted center
5811780080		pressurized center

Nominal flow Qn at 6 bar and Δp = 1 bar, The pilot can be set by turning the seal under the valve cover by 180°. For internal pilot the working pressure min/max is the same as the control pressure min/max.

## Technical information



The min. control pressure must be adhered to, since otherwise faulty switching and valve failure may result!

The pressure dew point must be at least 15 °C under ambient and medium temperature and may not exceed 3 °C .

The oil content of compressed air must remain constant during the life cycle.

Use only the approved oils from AVENTICS. Further information can be found in the "Technical information" document (available in the MediaCentre).

## Technical information

Housing	Polyamide
Seals	Acrylonitrile butadiene rubber

## Dimensions

### Dimensions

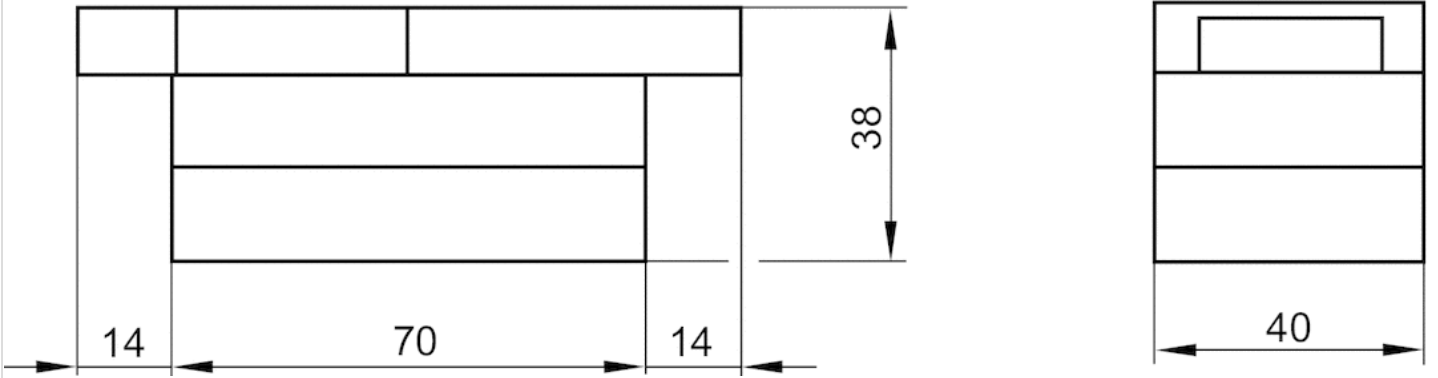

# 2x3/2-directional valve, Series 581, size 1

- Qn = 950 l/min
- Plate connection
- Compressed air connection output Base plate ISO 5599-1
- Can be assembled into blocks

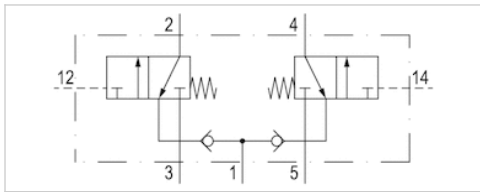

Type	Spool valve
Blocking principle	Single base plate principle
Sealing principle	Soft sealing
Connection type	Plate connection
Standards	ISO 5599-1, ISO 1
Nominal flow Qn	950 l/min
Compressed air connection	Base plate ISO 5599-1
Working pressure min./max.	0 ... 8 bar
Control pressure min./max.	3,5 ... 8 bar
Ambient temperature min./max.	-20 ... 70 °C
Medium temperature min./max.	-20 ... 70 °C
Medium	Compressed air class 6-4-3
Max. particle size	50 µm
Oil content of compressed air	0 ... 5 mg/m <sup>3</sup>
Mounting screw	with hexagon socket
Mounting screw tightening torque	2 Nm
Weight	0,21 kg

## Technical data

Part No.	NC/NC	Flow conductance	
		C-value	
R402003708	NC/NC	4,2 l/(s*bar)	

Nominal flow Qn at 6 bar and  $\Delta p = 1$  bar

## Technical information

The min. control pressure must be adhered to, since otherwise faulty switching and valve failure may result!  
 The pressure dew point must be at least 15 °C under ambient and medium temperature and may not exceed 3 °C .  
 The oil content of compressed air must remain constant during the life cycle.  
 Use only the approved oils from AVENTICS. Further information can be found in the "Technical information" document (available in the MediaCentre).

## Technical information

Housing	Aluminum
Seals	Acrylonitrile butadiene rubber

## Dimensions

### Dimensions

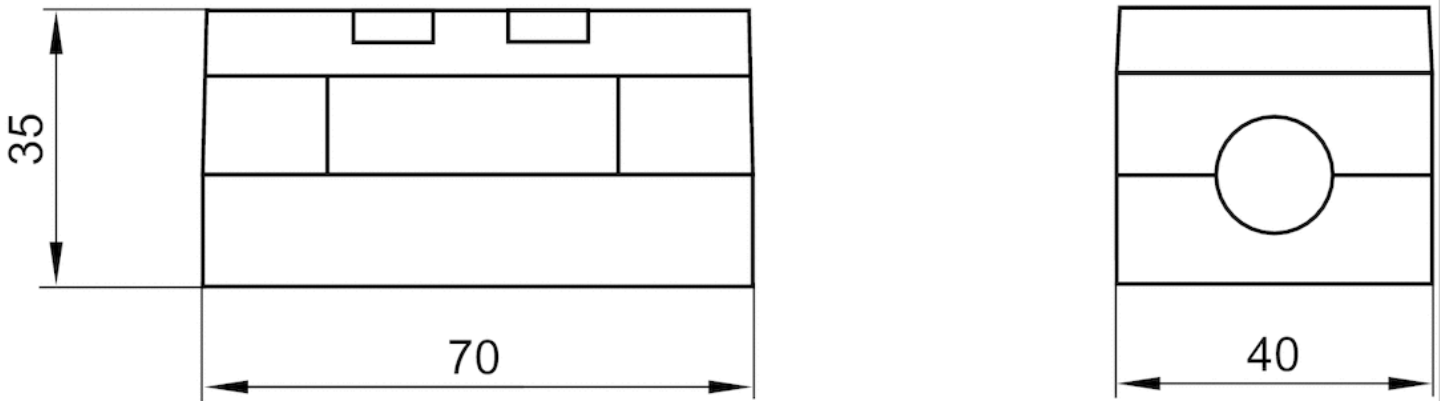



# 5/2-directional valve, Series 581, size 1

- Single air pilot
- $Q_n = 1400 \text{ l/min}$
- Plate connection
- Compressed air connection output Base plate ISO 5599-1
- Can be assembled into blocks



Type	Spool valve
Blocking principle	Single base plate principle
Sealing principle	Soft sealing
Connection type	Plate connection
Standards	ISO 5599-1, ISO 1
Nominal flow $Q_n$	1400 l/min
Compressed air connection	Base plate ISO 5599-1
Working pressure min./max.	-0,95 ... 16 bar
Control pressure min./max.	3 ... 16 bar
Ambient temperature min./max.	-20 ... 70 °C
Medium temperature min./max.	-20 ... 70 °C
Medium	Compressed air class 6-4-3
Max. particle size	50 $\mu\text{m}$
Oil content of compressed air	0 ... 5 $\text{mg/m}^3$
Mounting screw	with hexagon socket
Mounting screw tightening torque	2 Nm
Weight	0,21 kg

## Technical data

Part No.		Flow conductance	Throttle		
		C-value			
5811130000		5,2 l/(s*bar)	-	-	
5811131000		5,2 l/(s*bar)	with throttle	1)	

Connection 12 must be connected with atmospheres, Nominal flow  $Q_n$  at 6 bar and  $\Delta p = 1 \text{ bar}$

1) with throttle

## Technical information

The min. control pressure must be adhered to, since otherwise faulty switching and valve failure may result!

The pressure dew point must be at least 15 °C under ambient and medium temperature and may not exceed 3 °C .

The oil content of compressed air must remain constant during the life cycle.

Use only the approved oils from AVENTICS. Further information can be found in the "Technical information" document (available in the MediaCentre).

## Technical information

Housing	Aluminum
Seals	Acrylonitrile butadiene rubber

## Dimensions

## Dimensions

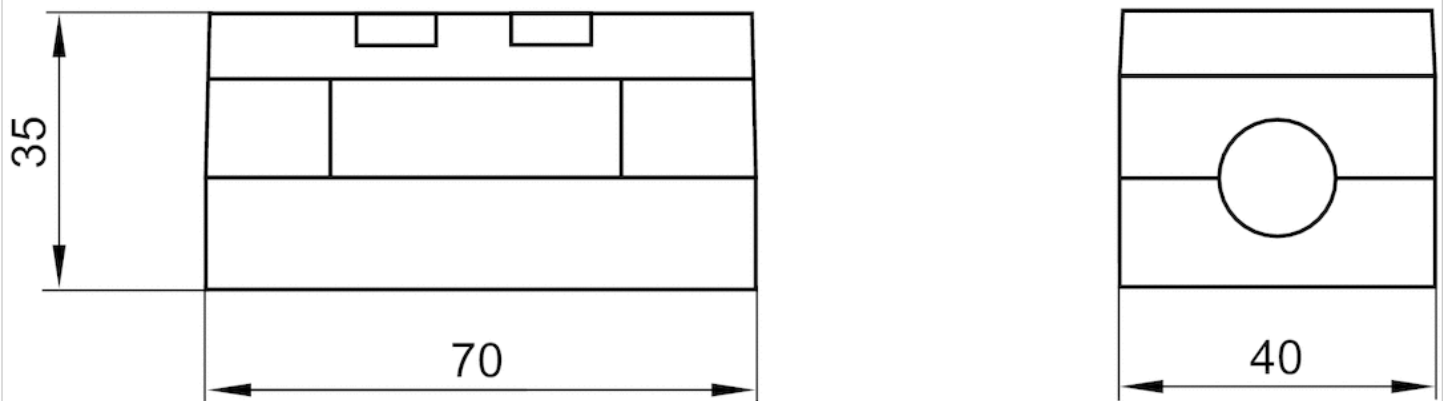



# 5/2-directional valve, Series 581, size 1

- double air pilot
- $Q_n = 1400 \text{ l/min}$
- Plate connection
- Compressed air connection output Base plate ISO 5599-1
- Can be assembled into blocks



Type	Spool valve
Blocking principle	Single base plate principle
Sealing principle	Soft sealing
Connection type	Plate connection
Standards	ISO 5599-1, ISO 1
Nominal flow $Q_n$	1400 l/min
Compressed air connection	Base plate ISO 5599-1
Working pressure min./max.	-0,95 ... 16 bar
Control pressure min./max.	1,5 ... 16 bar
Ambient temperature min./max.	-20 ... 70 °C
Medium temperature min./max.	-20 ... 70 °C
Medium	Compressed air class 6-4-3
Max. particle size	50 $\mu\text{m}$
Oil content of compressed air	0 ... 5 mg/m <sup>3</sup>
Mounting screw	with hexagon socket
Mounting screw tightening torque	2 Nm
Weight	0,21 kg

## Technical data

Part No.		Flow conductance	Throttle		
		C-value			
5811230000		5,2 l/(s*bar)	-	-	
5811231000		5,2 l/(s*bar)	with throttle	1)	

Nominal flow  $Q_n$  at 6 bar and  $\Delta p = 1 \text{ bar}$

1) with throttle

## Technical information

The min. control pressure must be adhered to, since otherwise faulty switching and valve failure may result!

The pressure dew point must be at least 15 °C under ambient and medium temperature and may not exceed 3 °C .

The oil content of compressed air must remain constant during the life cycle.

Use only the approved oils from AVENTICS. Further information can be found in the "Technical information" document (available in the MediaCentre).

## Technical information

Housing	Aluminum
Seals	Acrylonitrile butadiene rubber

## Dimensions

## Dimensions

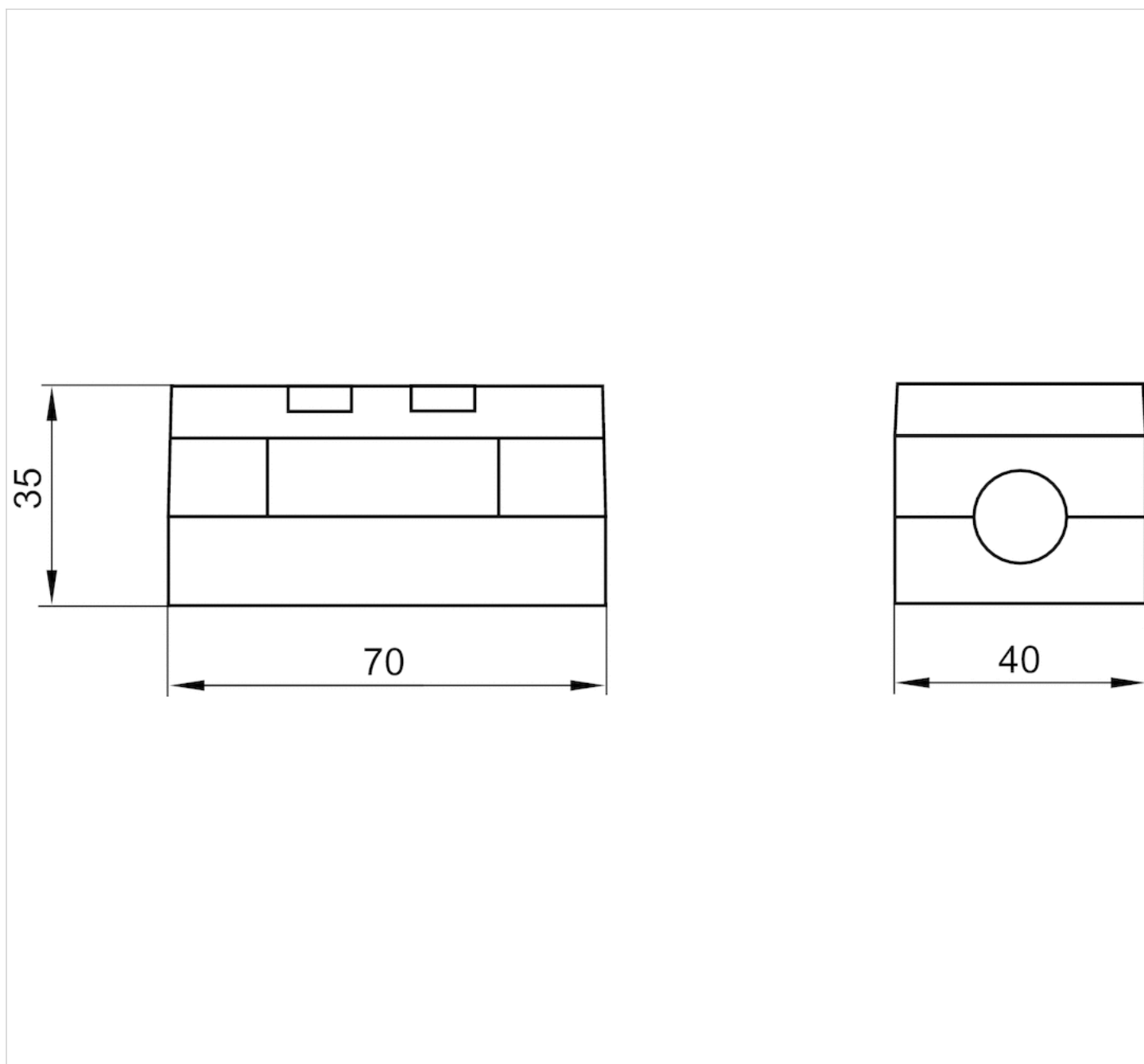





# 5/2-directional valve, Series 581, size 1

- Qn = 1400 l/min
- Plate connection
- Compressed air connection output Base plate ISO 5599-1
- Can be assembled into blocks
- Manual override without detent



Type	Spool valve
Blocking principle	Single base plate principle
Sealing principle	Soft sealing
Connection type	Plate connection
Standards	ISO 5599-1, ISO 1
Nominal flow Qn	1400 l/min
Compressed air connection	Base plate ISO 5599-1
Working pressure min./max.	-0,95 ... 16 bar
Control pressure min./max.	1,5 ... 16 bar
Ambient temperature min./max.	-20 ... 70 °C
Medium temperature min./max.	-20 ... 70 °C
Medium	Compressed air class 6-4-3
Max. particle size	50 µm
Oil content of compressed air	0 ... 5 mg/m <sup>3</sup>
Mounting screw	with hexagon socket
Mounting screw tightening torque	2 Nm
Weight	0,21 kg

## Technical data

Part No.		Flow conductance	Throttle		
		C-value			
5811330000		5,2 l/(s*bar)	-	-	
5811331000		5,2 l/(s*bar)	with throttle	1)	

Nominal flow Qn at 6 bar and  $\Delta p = 1$  bar

1) with throttle

## Technical information

The min. control pressure must be adhered to, since otherwise faulty switching and valve failure may result!

The pressure dew point must be at least 15 °C under ambient and medium temperature and may not exceed 3 °C .

The oil content of compressed air must remain constant during the life cycle.

Use only the approved oils from AVENTICS. Further information can be found in the "Technical information" document (available in the MediaCentre).

## Technical information

Housing	Aluminum
Seals	Acrylonitrile butadiene rubber

## Dimensions

### Dimensions

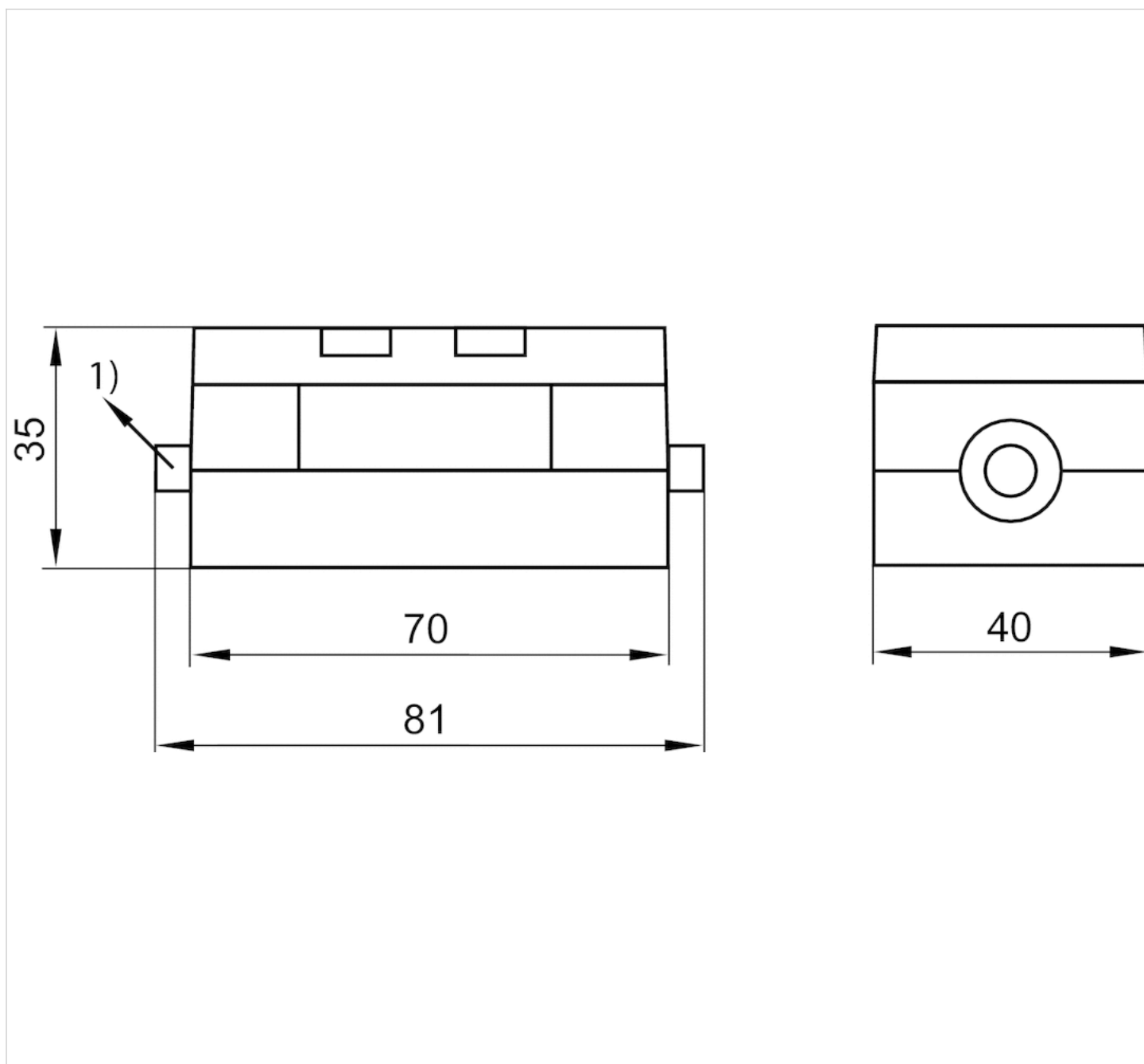

1) With manual override



# 5/2-directional valve, Series 581, size 1

- With differential piston
- $Q_n = 1400$  l/min
- Plate connection
- Compressed air connection output Base plate ISO 5599-1
- Can be assembled into blocks



Type	Spool valve
Blocking principle	Single base plate principle
Sealing principle	Soft sealing
Connection type	Plate connection
Standards	ISO 5599-1, ISO 1
Nominal flow $Q_n$	1400 l/min
Compressed air connection	Base plate ISO 5599-1
Working pressure min./max.	-0,95 ... 16 bar
Control pressure min./max.	1,3 ... 16 bar
Ambient temperature min./max.	-20 ... 70 °C
Medium temperature min./max.	-20 ... 70 °C
Medium	Compressed air class 6-4-3
Max. particle size	50 $\mu$ m
Oil content of compressed air	0 ... 5 mg/m <sup>3</sup>
Mounting screw	with hexagon socket
Mounting screw tightening torque	2 Nm
Weight	0,21 kg

## Technical data

Part No.		Flow conductance	Throttle	
		C-value		
5811630000		5,2 l/(s*bar)	-	
5811631000		5,2 l/(s*bar)	with throttle	

Differential piston, signal 14 has priority, Nominal flow  $Q_n$  at 6 bar and  $\Delta p = 1$  bar

## Technical information

The min. control pressure must be adhered to, since otherwise faulty switching and valve failure may result!  
 The pressure dew point must be at least 15 °C under ambient and medium temperature and may not exceed 3 °C .  
 The oil content of compressed air must remain constant during the life cycle.  
 Use only the approved oils from AVENTICS. Further information can be found in the "Technical information" document (available in the MediaCentre).

## Technical information

Housing	Aluminum
Seals	Acrylonitrile butadiene rubber

## Dimensions

### Dimensions

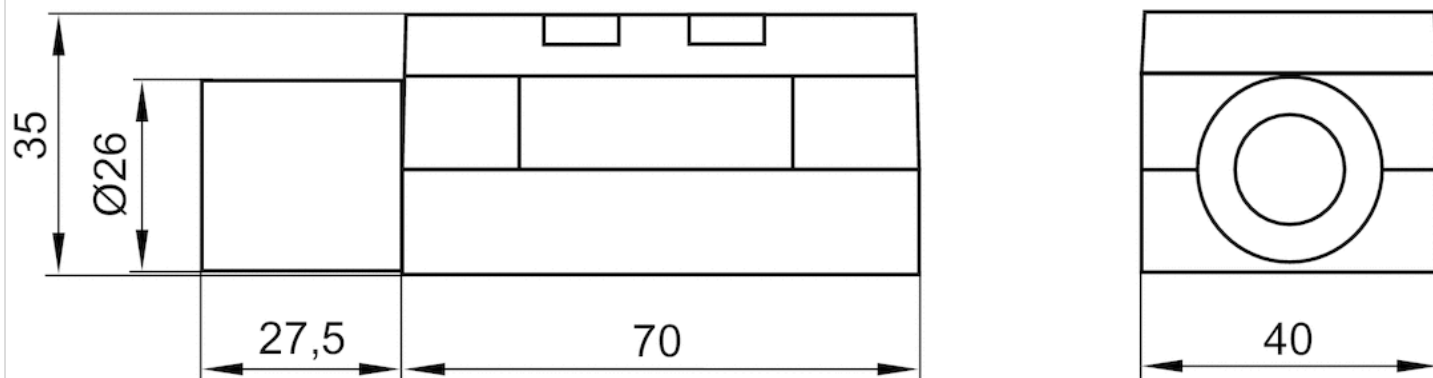







# 5/3-directional valve, Series 581, size 1

- Qn = 1100 l/min
- Plate connection
- Compressed air connection output Base plate ISO 5599-1
- Can be assembled into blocks



Type	Spool valve
Blocking principle	Single base plate principle
Sealing principle	Soft sealing
Connection type	Plate connection
Standards	ISO 5599-1, ISO 1
Nominal flow Qn	1100 l/min
Compressed air connection	Base plate ISO 5599-1
Working pressure min./max.	-0,95 ... 16 bar
Control pressure min./max.	3 ... 16 bar
Ambient temperature min./max.	-20 ... 70 °C
Medium temperature min./max.	-20 ... 70 °C
Medium	Compressed air class 6-4-3
Max. particle size	50 µm
Oil content of compressed air	0 ... 5 mg/m <sup>3</sup>
Mounting screw	with hexagon socket
Mounting screw tightening torque	2 Nm
Weight	0,21 kg

## Technical data

Part No.			Flow conductance	Throttle	
			C-value		
5811430000		closed center	4,3 l/(s*bar)	-	
5811431000		closed center	4,3 l/(s*bar)	with throttle	
5811530000		exhausted center	4,3 l/(s*bar)	-	
5811531000		exhausted center	4,3 l/(s*bar)	with throttle	
5811730000		pressurized center	4,3 l/(s*bar)	-	
5811731000		pressurized center	4,3 l/(s*bar)	with throttle	

Nominal flow Qn at 6 bar and  $\Delta p = 1$  bar

## Technical information

The min. control pressure must be adhered to, since otherwise faulty switching and valve failure may result!

The pressure dew point must be at least 15 °C under ambient and medium temperature and may not exceed 3 °C .

The oil content of compressed air must remain constant during the life cycle.

Use only the approved oils from AVENTICS. Further information can be found in the "Technical information" document (available in the MediaCentre).

## Technical information

Housing	Aluminum
Seals	Acrylonitrile butadiene rubber

## Dimensions

## Dimensions

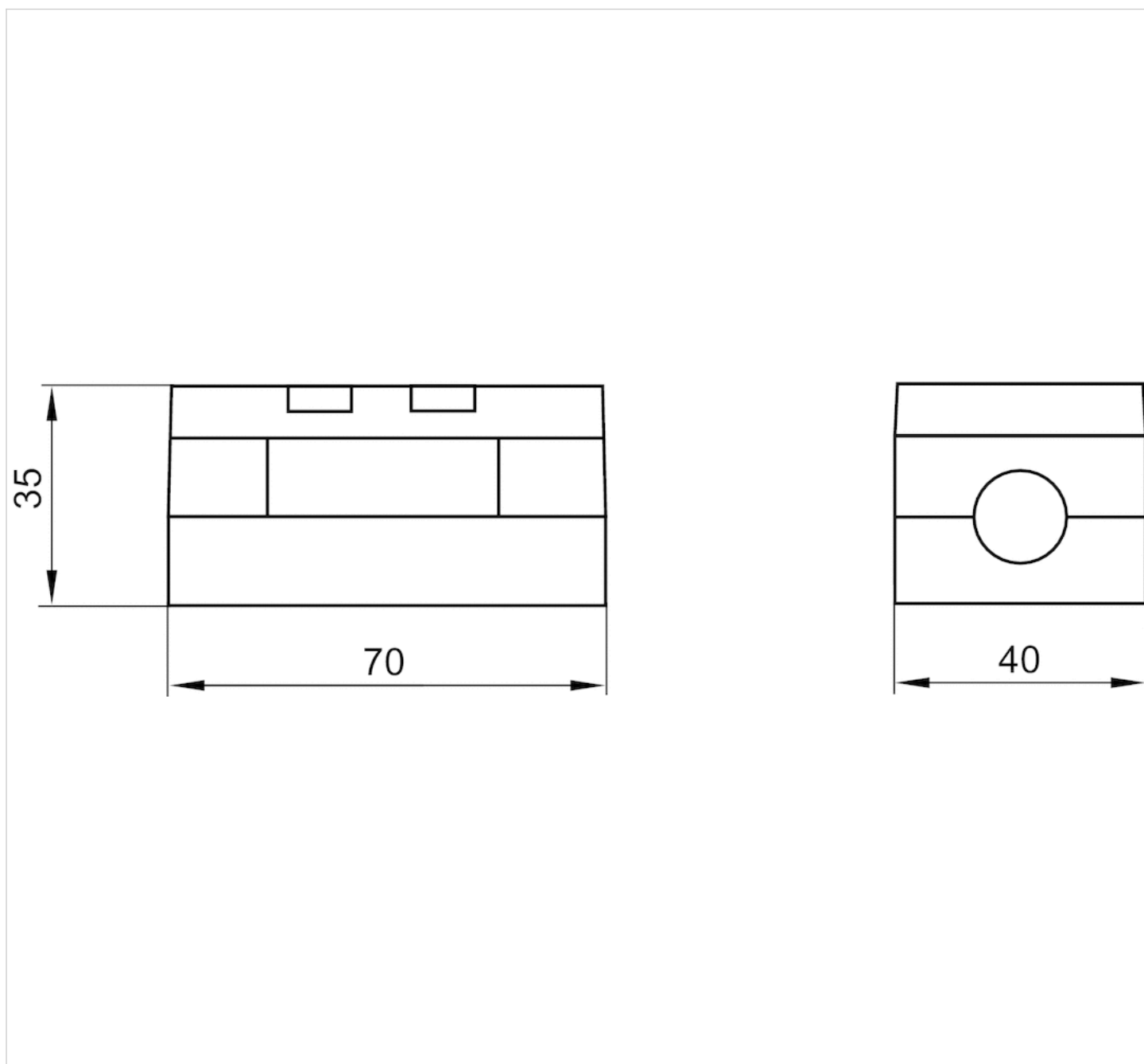

# 5/2-directional valve, Series 581, size 1

## 5811180100

ISO 5599-1, size 1, series 581

■  $Q_n = 950 \dots 1400 \text{ l/min}$



### Technical data

Industry  
Industrial

Nominal flow  $Q_n$   
1400 l/min

Switching principle  
5/2

Compressed air connection output  
Base plate ISO 5599-1

Working pressure min.  
-0.95 bar

Working pressure max  
16 bar

Actuating control  
Single Solenoid

Sealing principle  
Soft Seal

Pilot  
External  
Internal

ATEX  
ATEX

II 2G Ex h IIC T6 Gb

II 2D Ex h IIIC T85°C Db IP65

Standards  
ISO 5599-1

Pilot valve width  
30 mm

Valve type  
Spool valve

Blocking principle  
Single base plate principle

Connection type  
Plate connection

Return  
With spring return

Compressed air connection input  
Base plate ISO 5599-1

Compressed air connection, exhaust  
Base plate ISO 5599-1

Flow conductance C  
5.2 l/(s\*bar)

basic valve with electrical connector  
Basic valve without pilot valve

Frame size  
ISO 1

Control pressure min.  
3 bar

Control pressure max.  
16 bar

Min. ambient temperature  
-20 °C

Max. ambient temperature  
70 °C

Min. medium temperature  
-20 °C

Max. medium temperature  
70 °C

Medium  
Compressed air

Max. particle size  
50 µm

Oil content of compressed air min.  
0 mg/m<sup>3</sup>

Oil content of compressed air max.  
5 mg/m<sup>3</sup>

Protection class with connection  
IP65

Duty cycle  
100 %

mounting screws  
with hexagon socket

Mounting screw tightening torque  
2 Nm

Weight  
0.21 kg

Housing material  
Aluminum

Seal material  
Acrylonitrile butadiene rubber

Part No.  
5811180100

## Dimensions

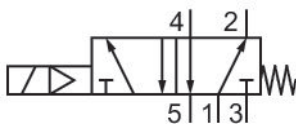
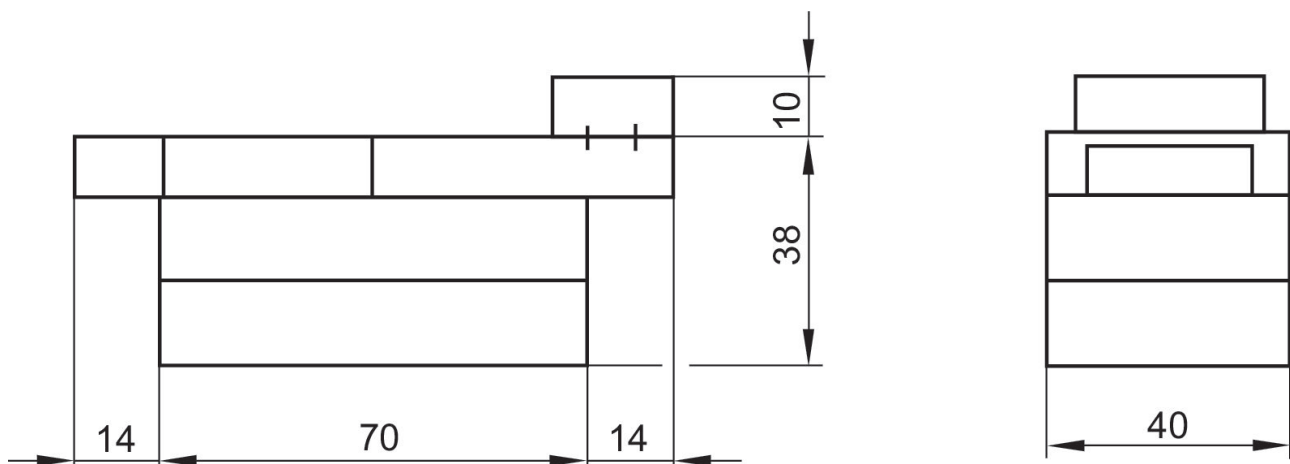



# 5/2-directional valve, Series 581, size 1

## 5811280100

ISO 5599-1, size 1, series 581

■  $Q_n = 950 \dots 1400$  l/min



### Technical data

Industry  
Industrial

Nominal flow  $Q_n$   
1400 l/min

Switching principle  
5/2

Compressed air connection output  
Base plate ISO 5599-1

Working pressure min.  
-0.95 bar

Working pressure max  
16 bar

Actuating control  
Double Solenoid

Sealing principle  
Soft Seal

Pilot  
External  
Internal

ATEX  
ATEX

II 2G Ex h IIC T6 Gb

II 2D Ex h IIIC T85°C Db IP65

Standards  
ISO 5599-1

Pilot valve width  
30 mm

Valve type  
Spool valve

Blocking principle  
Single base plate principle

Connection type  
Plate connection

Compressed air connection input  
Base plate ISO 5599-1

Compressed air connection, exhaust  
Base plate ISO 5599-1

Flow conductance C  
5.2 l/(s\*bar)

basic valve with electrical connector  
Basic valve without pilot valve

Frame size  
ISO 1

Control pressure min.  
1.5 bar

Control pressure max.  
16 bar

Min. ambient temperature  
-20 °C

Max. ambient temperature  
70 °C

Min. medium temperature  
-20 °C

Max. medium temperature  
70 °C

Medium  
Compressed air

Max. particle size  
50 µm

Oil content of compressed air min.  
0 mg/m<sup>3</sup>

Oil content of compressed air max.  
5 mg/m<sup>3</sup>

Protection class with connection  
IP65

Duty cycle  
100 %

mounting screws  
with hexagon socket

Mounting screw tightening torque  
2 Nm

Weight  
0.21 kg

Housing material  
Aluminum

Seal material  
Acrylonitrile butadiene rubber

Part No.  
5811280100

## Dimensions

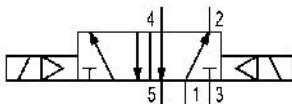
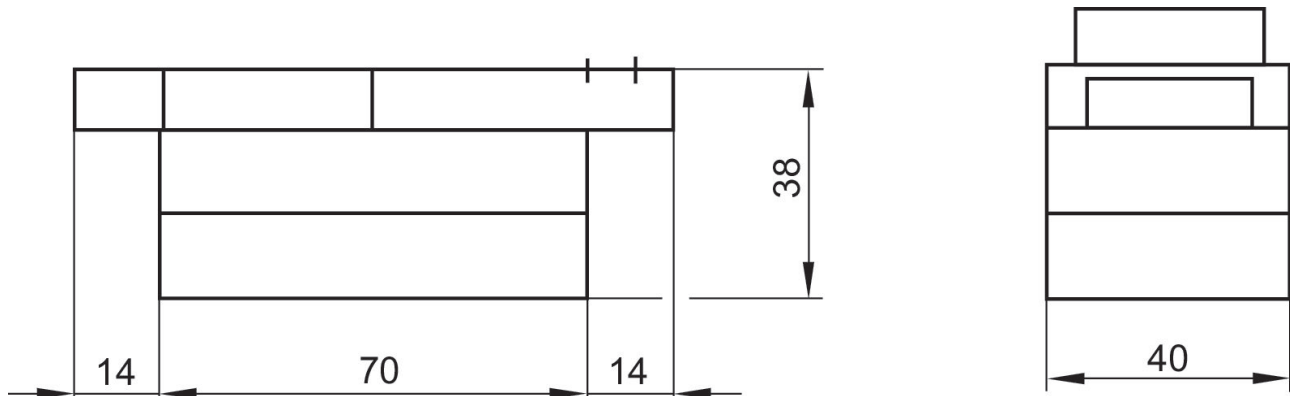

# 5/3-directional valve, Series 581, size 1

## 5811480100

ISO 5599-1, size 1, series 581

■  $Q_n = 950 \dots 1400 \text{ l/min}$



### Technical data

Industry  
Industrial

Nominal flow  $Q_n$   
1100 l/min

Switching principle  
5/3

Version  
Closed Center

Compressed air connection output  
Base plate ISO 5599-1

Working pressure min.  
-0.95 bar

Working pressure max  
16 bar

Sealing principle  
Soft Seal

Pilot  
External  
Internal

ATEX  
ATEX

II 2G Ex h IIC T6 Gb

II 2D Ex h IIIC T85°C Db IP65

Standards  
ISO 5599-1

Pilot valve width  
30 mm

Valve type  
Spool valve

Blocking principle  
Single base plate principle

Connection type  
Plate connection

Compressed air connection input  
Base plate ISO 5599-1

Compressed air connection, exhaust  
Base plate ISO 5599-1

Flow conductance C  
4.3 l/(s\*bar)

basic valve with electrical connector  
Basic valve without pilot valve

Frame size  
ISO 1

Control pressure min.  
3 bar

Control pressure max.  
16 bar

Min. ambient temperature  
-20 °C

Max. ambient temperature  
70 °C

Min. medium temperature  
-20 °C

Max. medium temperature  
70 °C

Medium  
Compressed air

Max. particle size  
50 µm

Oil content of compressed air min.  
0 mg/m<sup>3</sup>

Oil content of compressed air max.  
5 mg/m<sup>3</sup>

Protection class with connection  
IP65

Duty cycle  
100 %

mounting screws  
with hexagon socket

Mounting screw tightening torque  
2 Nm

Weight  
0.21 kg

Housing material  
Aluminum

Seal material  
Acrylonitrile butadiene rubber

Part No.  
5811480100

## Dimensions

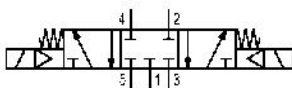
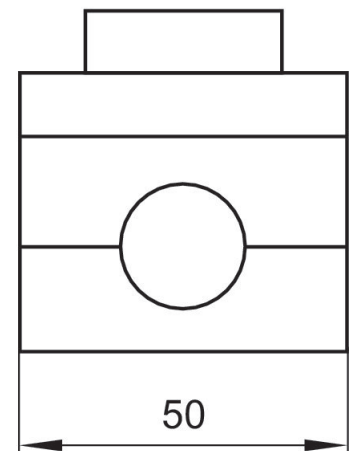
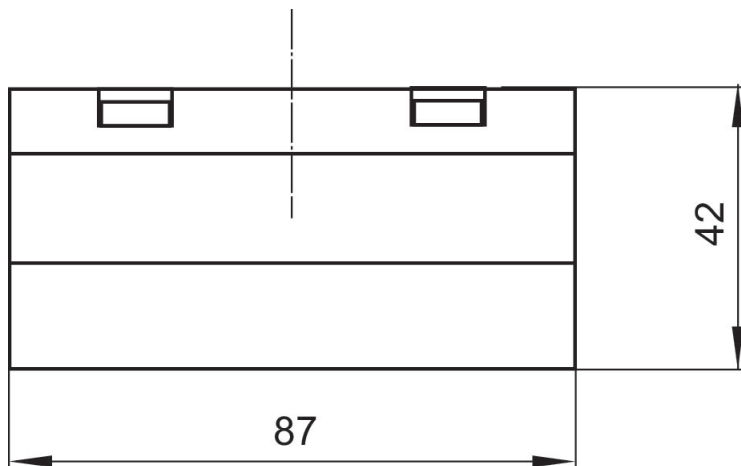

# 5/3-directional valve, Series 581, size 1

## 5811580100

ISO 5599-1, size 1, series 581

■  $Q_n = 950 \dots 1400 \text{ l/min}$



### Technical data

Industry  
Industrial

Nominal flow  $Q_n$   
1100 l/min

Switching principle  
5/3

Version  
Exhausted Center

Compressed air connection output  
Base plate ISO 5599-1

Working pressure min.  
-0.95 bar

Working pressure max  
16 bar

Sealing principle  
Soft Seal

Pilot  
External  
Internal

ATEX  
ATEX

II 2G Ex h IIC T6 Gb

II 2D Ex h IIIC T85°C Db IP65

Standards  
ISO 5599-1

Pilot valve width  
30 mm

Valve type  
Spool valve

Blocking principle  
Single base plate principle

Connection type  
Plate connection

Compressed air connection input  
Base plate ISO 5599-1

Compressed air connection, exhaust  
Base plate ISO 5599-1

Flow conductance C  
4.3 l/(s\*bar)

basic valve with electrical connector  
Basic valve without pilot valve

Frame size  
ISO 1

Control pressure min.  
3 bar

Control pressure max.  
16 bar

Min. ambient temperature  
-20 °C

Max. ambient temperature  
70 °C

Min. medium temperature  
-20 °C

Max. medium temperature  
70 °C

Medium  
Compressed air

Max. particle size  
50 µm

Oil content of compressed air min.  
0 mg/m<sup>3</sup>

Oil content of compressed air max.  
5 mg/m<sup>3</sup>

Protection class with connection  
IP65

Duty cycle  
100 %

mounting screws  
with hexagon socket

Mounting screw tightening torque  
2 Nm

Weight  
0.21 kg

Housing material  
Aluminum

Seal material  
Acrylonitrile butadiene rubber

Part No.  
5811580100

## Dimensions

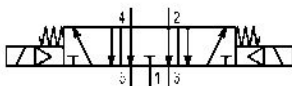
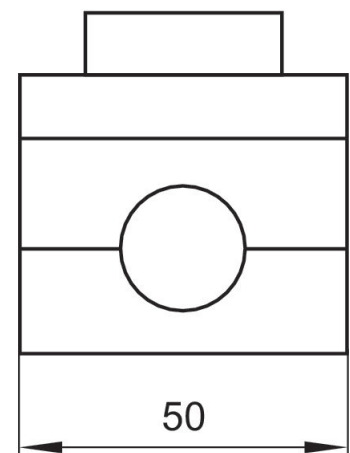
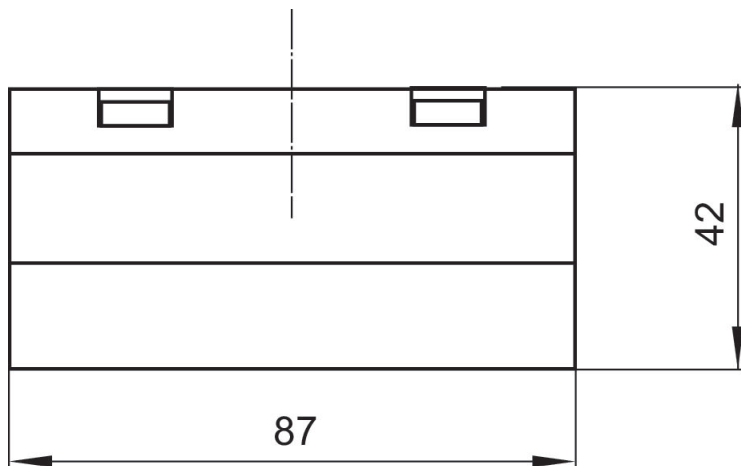

# 5/2-directional valve, Series 581, size 1

## 5811680100

ISO 5599-1, size 1, series 581

■  $Q_n = 950 \dots 1400$  l/min



### Technical data

Industry  
Industrial

Nominal flow  $Q_n$   
1400 l/min

Switching principle  
5/2

Compressed air connection output  
Base plate ISO 5599-1

Working pressure min.  
-0.95 bar

Working pressure max  
16 bar

Sealing principle  
Soft Seal

Pilot  
External  
Internal

ATEX  
ATEX

II 2G Ex h IIC T6 Gb

II 2D Ex h IIIC T85°C Db IP65

Standards  
ISO 5599-1

Pilot valve width  
30 mm

Valve type  
Spool valve

Blocking principle  
Single base plate principle

Connection type  
Plate connection

Return  
Air return with differential piston

Compressed air connection input  
Base plate ISO 5599-1

Compressed air connection, exhaust  
Base plate ISO 5599-1

Flow conductance C  
5.2 l/(s\*bar)

basic valve with electrical connector  
Basic valve without pilot valve

Control pressure min.  
1.3 bar

Control pressure max.  
16 bar

Min. ambient temperature  
-20 °C

Max. ambient temperature  
70 °C

Min. medium temperature  
-20 °C

Max. medium temperature  
70 °C

Medium  
Compressed air

Max. particle size  
50 µm

Oil content of compressed air min.  
0 mg/m<sup>3</sup>

Oil content of compressed air max.  
5 mg/m<sup>3</sup>

Protection class with connection  
IP65

Duty cycle  
100 %

mounting screws  
with hexagon socket

Mounting screw tightening torque  
2 Nm

Weight  
0.21 kg

Housing material  
Aluminum

Seal material  
Acrylonitrile butadiene rubber

Part No.  
5811680100

## Dimensions

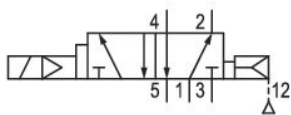
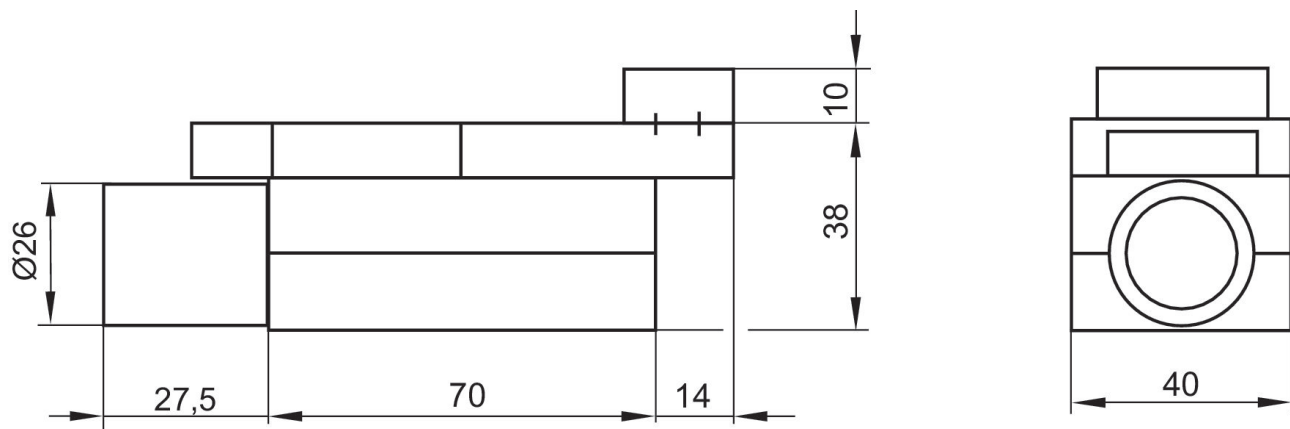



# 5/3-directional valve, Series 581, size 1

## 5811780100

ISO 5599-1, size 1, series 581

■  $Q_n = 950 \dots 1400 \text{ l/min}$

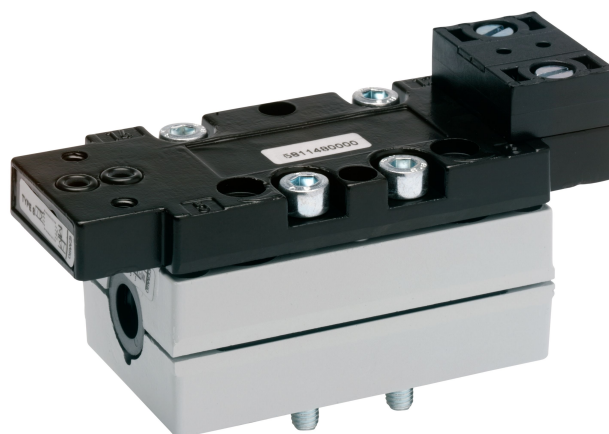

### Technical data

Industry  
Industrial

Nominal flow  $Q_n$   
1100 l/min

Switching principle  
5/3

Version  
Pressurized Center

Compressed air connection output  
Base plate ISO 5599-1

Working pressure min.  
-0.95 bar

Working pressure max  
16 bar

Sealing principle  
Soft Seal

Pilot  
External  
Internal

ATEX  
ATEX

II 2G Ex h IIC T6 Gb

II 2D Ex h IIIC T85°C Db IP65

Standards  
ISO 5599-1

Pilot valve width  
30 mm

Valve type  
Spool valve

Blocking principle  
Single base plate principle

Connection type  
Plate connection

Compressed air connection input  
Base plate ISO 5599-1

Compressed air connection, exhaust  
Base plate ISO 5599-1

Flow conductance C  
4.3 l/(s\*bar)

basic valve with electrical connector  
Basic valve without pilot valve

Frame size  
ISO 1

Control pressure min.  
3 bar

Control pressure max.  
16 bar

Min. ambient temperature  
-20 °C

Max. ambient temperature  
70 °C

Min. medium temperature  
-20 °C

Max. medium temperature  
70 °C

Medium  
Compressed air

Max. particle size  
50 µm

Oil content of compressed air min.  
0 mg/m<sup>3</sup>

Oil content of compressed air max.  
5 mg/m<sup>3</sup>

Protection class with connection  
IP65

Duty cycle  
100 %

mounting screws  
with hexagon socket

Mounting screw tightening torque  
2 Nm

Weight  
0.21 kg

Housing material  
Aluminum

Seal material  
Acrylonitrile butadiene rubber

Part No.  
5811780100

## Dimensions

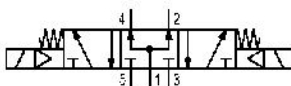
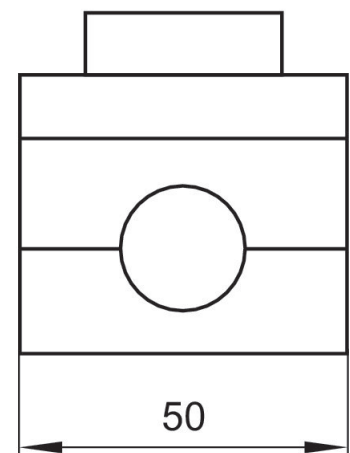
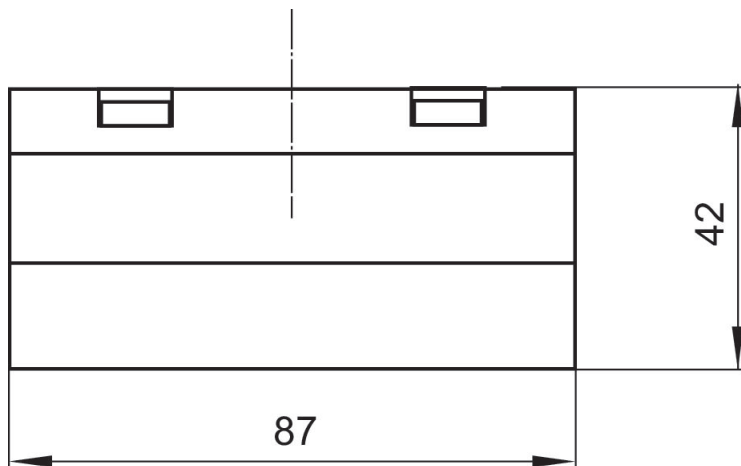

# 5/2-directional valve, Series 581, size 1

## 5811130100

ISO 5599-1, size 1, series 581

■  $Q_n = [[1400]]$  l/min]



### Technical data

**Industry**  
Industrial

**Activation**  
Pneumatically

**Nominal flow  $Q_n$**   
1400 l/min

**Compressed air connection output**  
Base plate ISO 5599-1

**Connection type**  
Plate connection

**Working pressure min.**  
-0.95 bar

**Working pressure max**  
16 bar

**Sealing principle**  
Soft Seal

**ATEX**  
ATEX

II 2G Ex h IIC T6 Gb

II 2D Ex h IIIC T85°C Db IP65

**Standards**  
ISO 5599-1

**Valve type**  
Spool valve

**Version**  
ISO 1

**Can be assembled into blocks**  
Can be assembled into blocks

**Blocking principle**  
Single base plate principle

**Control pressure min.**  
3 bar

**Control pressure max.**  
16 bar

**Min. ambient temperature**  
-20 °C

**Max. ambient temperature**  
70 °C

**Min. medium temperature**  
-20 °C

Max. medium temperature  
70 °C

Medium  
Compressed air

Max. particle size  
50 µm

Oil content of compressed air min.  
0 mg/m<sup>3</sup>

Oil content of compressed air max.  
5 mg/m<sup>3</sup>

Compressed air connection input  
Base plate ISO 5599-1

Flow conductance C  
5.2 l/(s\*bar)

Mounting screw  
with hexagon socket

Mounting screw tightening torque  
2 Nm

Weight  
0.21 kg

Housing material  
Aluminum

Seal material  
Acrylonitrile butadiene rubber

Part No.  
5811130100

## Dimensions

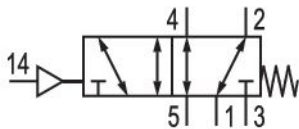
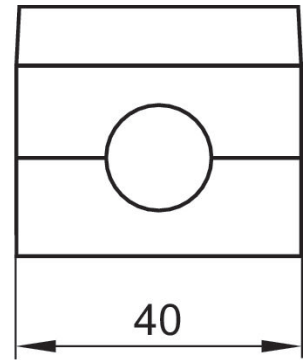
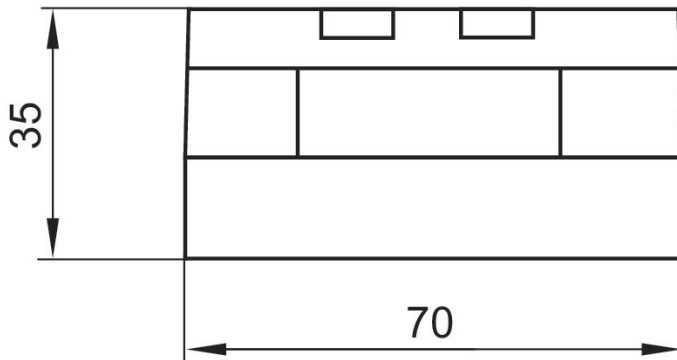

# 5/2-directional valve, Series 581, size 1

## 5811230100

ISO 5599-1, size 1, series 581

■  $Q_n = [[1400]]$  l/min]



### Technical data

**Industry**  
Industrial

**Activation**  
Pneumatically

**Nominal flow  $Q_n$**   
1400 l/min

**Compressed air connection output**  
Base plate ISO 5599-1

**Connection type**  
Plate connection

**Working pressure min.**  
-0.95 bar

**Working pressure max**  
16 bar

**Sealing principle**  
Soft Seal

**ATEX**  
ATEX

II 2G Ex h IIC T6 Gb

II 2D Ex h IIIC T85°C Db IP65

**Standards**  
ISO 5599-1

**Valve type**  
Spool valve

**Version**  
ISO 1

**Can be assembled into blocks**  
Can be assembled into blocks

**Blocking principle**  
Single base plate principle

**Control pressure min.**  
1.5 bar

**Control pressure max.**  
16 bar

**Min. ambient temperature**  
-20 °C

**Max. ambient temperature**  
70 °C

**Min. medium temperature**  
-20 °C

Max. medium temperature  
70 °C

Medium  
Compressed air

Max. particle size  
50 µm

Oil content of compressed air min.  
0 mg/m<sup>3</sup>

Oil content of compressed air max.  
5 mg/m<sup>3</sup>

Compressed air connection input  
Base plate ISO 5599-1

Flow conductance C  
5.2 l/(s\*bar)

Mounting screw  
with hexagon socket

Mounting screw tightening torque  
2 Nm

Weight  
0.21 kg

Housing material  
Aluminum

Seal material  
Acrylonitrile butadiene rubber

Part No.  
5811230100

## Dimensions

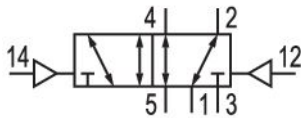
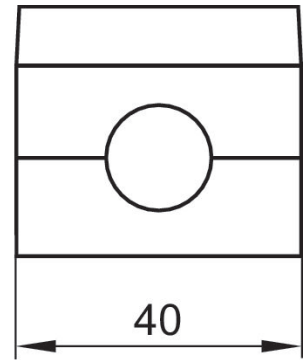
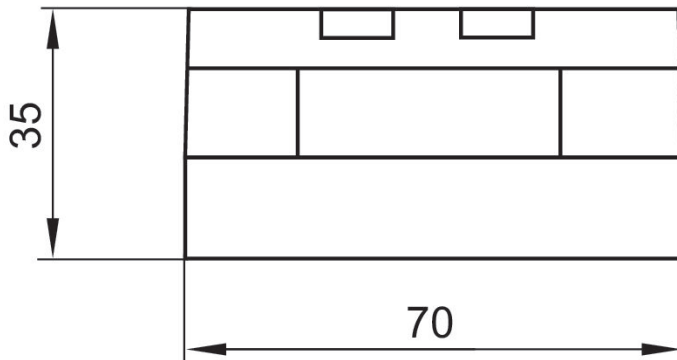

# 5/2-directional valve, Series 581, size 1

## 5811330100

ISO 5599-1, size 1, series 581

■  $Q_n = [1400]$  l/min



### Technical data

**Industry**  
Industrial

**Activation**  
Pneumatically

**Nominal flow  $Q_n$**   
1400 l/min

**Compressed air connection output**  
Base plate ISO 5599-1

**Connection type**  
Plate connection

**Working pressure min.**  
-0.95 bar

**Working pressure max**  
16 bar

**Sealing principle**  
Soft Seal

**ATEX**  
ATEX

II 2G Ex h IIC T6 Gb

II 2D Ex h IIIC T85°C Db IP65

**Standards**  
ISO 5599-1

**Valve type**  
Spool valve

**Version**  
ISO 1

**Can be assembled into blocks**  
Can be assembled into blocks

**Blocking principle**  
Single base plate principle

**Control pressure min.**  
3 bar

**Control pressure max.**  
16 bar

**Min. ambient temperature**  
-20 °C

**Max. ambient temperature**  
70 °C

**Min. medium temperature**  
-20 °C

Max. medium temperature  
70 °C

Medium  
Compressed air

Max. particle size  
50 µm

Oil content of compressed air min.  
0 mg/m<sup>3</sup>

Oil content of compressed air max.  
5 mg/m<sup>3</sup>

Compressed air connection input  
Base plate ISO 5599-1

Flow conductance C  
5.2 l/(s\*bar)

Mounting screw  
with hexagon socket

Mounting screw tightening torque  
2 Nm

Weight  
0.21 kg

Housing material  
Aluminum

Seal material  
Acrylonitrile butadiene rubber

Part No.  
5811330100

## Dimensions

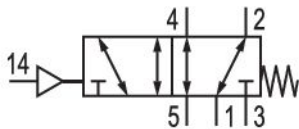
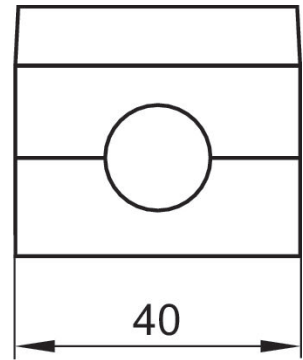
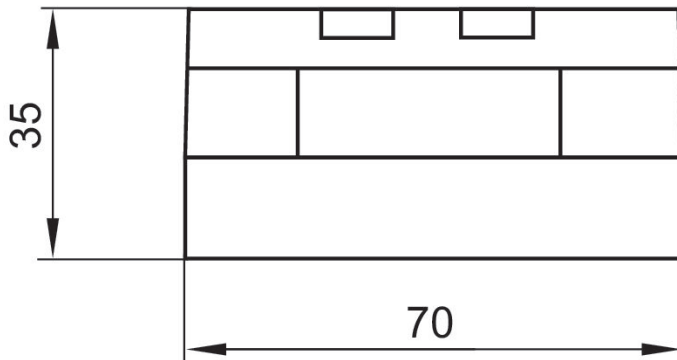



# 5/3-directional valve, Series 581, size 1

## 5811430100

ISO 5599-1, size 1, series 581

■  $Q_n = [[1400]]$  l/min]



### Technical data

**Industry**  
Industrial

**Activation**  
Pneumatically

**Nominal flow  $Q_n$**   
1100 l/min

**Compressed air connection output**  
Base plate ISO 5599-1

**Connection type**  
Plate connection

**Working pressure min.**  
-0.95 bar

**Working pressure max**  
16 bar

**Sealing principle**  
Soft Seal

**ATEX**  
ATEX

II 2G Ex h IIC T6 Gb

II 2D Ex h IIIC T85°C Db IP65

**Standards**  
ISO 5599-1

**Valve type**  
Spool valve

**Version**  
ISO 1

**Can be assembled into blocks**  
Can be assembled into blocks

**Blocking principle**  
Single base plate principle

**Control pressure min.**  
3 bar

**Control pressure max.**  
16 bar

**Min. ambient temperature**  
-20 °C

**Max. ambient temperature**  
70 °C

**Min. medium temperature**  
-20 °C

Max. medium temperature  
70 °C

Medium  
Compressed air

Max. particle size  
50 µm

Oil content of compressed air min.  
0 mg/m<sup>3</sup>

Oil content of compressed air max.  
5 mg/m<sup>3</sup>

version pneumatic port  
Closed Center

Compressed air connection input  
Base plate ISO 5599-1

Flow conductance C  
4.3 l/(s\*bar)

Mounting screw  
with hexagon socket

Mounting screw tightening torque  
2 Nm

Weight  
0.21 kg

Housing material  
Aluminum

Seal material  
Acrylonitrile butadiene rubber

Part No.  
5811430100

## Dimensions

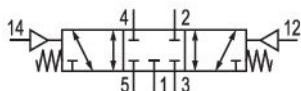
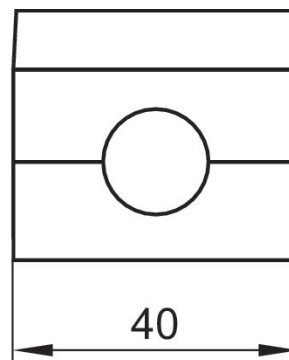
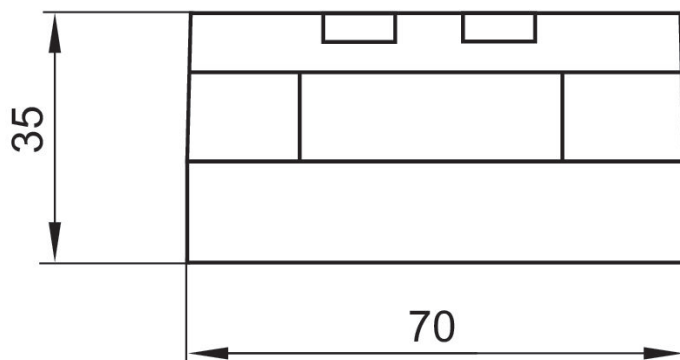

# 5/3-directional valve, Series 581, size 1

## 5811530100

ISO 5599-1, size 1, series 581

■  $Q_n = [[1400]]$  l/min]



### Technical data

**Industry**  
Industrial

**Activation**  
Pneumatically

**Nominal flow  $Q_n$**   
1100 l/min

**Compressed air connection output**  
Base plate ISO 5599-1

**Connection type**  
Plate connection

**Working pressure min.**  
-0.95 bar

**Working pressure max**  
16 bar

**Sealing principle**  
Soft Seal

**ATEX**  
ATEX

II 2G Ex h IIC T6 Gb

II 2D Ex h IIIC T85°C Db IP65

**Standards**  
ISO 5599-1

**Valve type**  
Spool valve

**Version**  
ISO 1

**Can be assembled into blocks**  
Can be assembled into blocks

**Blocking principle**  
Single base plate principle

**Control pressure min.**  
3 bar

**Control pressure max.**  
16 bar

**Min. ambient temperature**  
-20 °C

**Max. ambient temperature**  
70 °C

**Min. medium temperature**  
-20 °C

Max. medium temperature  
70 °C

Medium  
Compressed air

Max. particle size  
50 µm

Oil content of compressed air min.  
0 mg/m<sup>3</sup>

Oil content of compressed air max.  
5 mg/m<sup>3</sup>

version pneumatic port  
Exhausted Center

Compressed air connection input  
Base plate ISO 5599-1

Flow conductance C  
4.3 l/(s\*bar)

Mounting screw  
with hexagon socket

Mounting screw tightening torque  
2 Nm

Weight  
0.21 kg

Housing material  
Aluminum

Seal material  
Acrylonitrile butadiene rubber

Part No.  
5811530100

## Dimensions

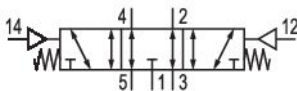
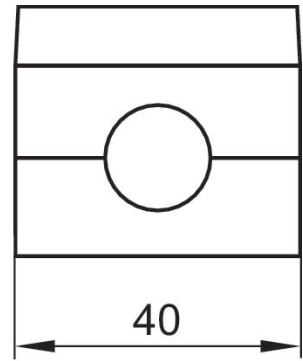
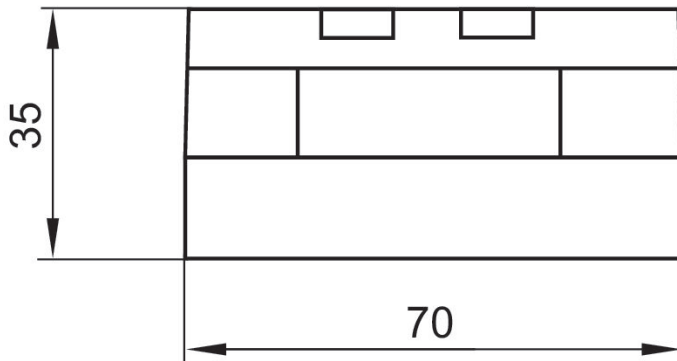

# 5/2-directional valve, Series 581, size 1

## 5811630100

ISO 5599-1, size 1, series 581

■  $Q_n = [1400]$  l/min



### Technical data

**Industry**  
Industrial

**Activation**  
Pneumatically

**Nominal flow  $Q_n$**   
1400 l/min

**Compressed air connection output**  
Base plate ISO 5599-1

**Connection type**  
Plate connection

**Working pressure min.**  
-0.95 bar

**Working pressure max**  
16 bar

**Sealing principle**  
Soft Seal

**ATEX**  
ATEX

II 2G Ex h IIC T6 Gb

II 2D Ex h IIIC T85°C Db IP65

**Standards**  
ISO 5599-1

**Valve type**  
Spool valve

**Version**  
ISO 1

**Can be assembled into blocks**  
Can be assembled into blocks

**Blocking principle**  
Single base plate principle

**Control pressure min.**  
1.3 bar

**Control pressure max.**  
16 bar

**Min. ambient temperature**  
-20 °C

**Max. ambient temperature**  
70 °C

**Min. medium temperature**  
-20 °C

Max. medium temperature  
70 °C

Medium  
Compressed air

Max. particle size  
50 µm

Oil content of compressed air min.  
0 mg/m<sup>3</sup>

Oil content of compressed air max.  
5 mg/m<sup>3</sup>

Compressed air connection input  
Base plate ISO 5599-1

Flow conductance C  
5.2 l/(s\*bar)

Mounting screw  
with hexagon socket

Mounting screw tightening torque  
2 Nm

Weight  
0.21 kg

Housing material  
Aluminum

Seal material  
Acrylonitrile butadiene rubber

Part No.  
5811630100

## Dimensions

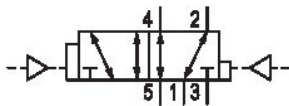
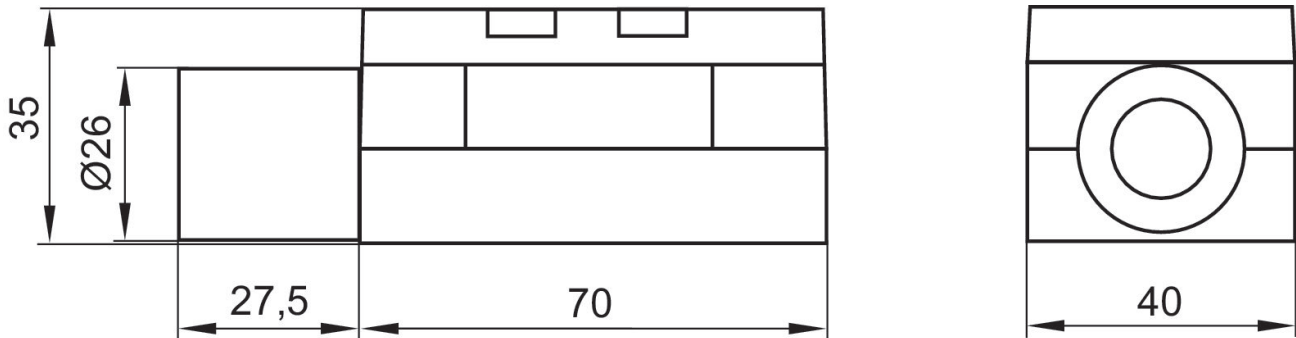

# 5/3-directional valve, Series 581, size 1

## 5811730100

ISO 5599-1, size 1, series 581

■  $Q_n = [[1400] \text{ l/min}]$



### Technical data

**Industry**  
Industrial

**Activation**  
Pneumatically

**Nominal flow  $Q_n$**   
1100 l/min

**Compressed air connection output**  
Base plate ISO 5599-1

**Connection type**  
Plate connection

**Working pressure min.**  
-0.95 bar

**Working pressure max**  
16 bar

**Sealing principle**  
Soft Seal

**ATEX**  
ATEX

II 2G Ex h IIC T6 Gb

II 2D Ex h IIIC T85°C Db IP65

**Standards**  
ISO 5599-1

**Valve type**  
Spool valve

**Version**  
ISO 1

**Can be assembled into blocks**  
Can be assembled into blocks

**Blocking principle**  
Single base plate principle

**Control pressure min.**  
3 bar

**Control pressure max.**  
16 bar

**Min. ambient temperature**  
-20 °C

**Max. ambient temperature**  
70 °C

**Min. medium temperature**  
-20 °C

Max. medium temperature  
70 °C

Medium  
Compressed air

Max. particle size  
50 µm

Oil content of compressed air min.  
0 mg/m<sup>3</sup>

Oil content of compressed air max.  
5 mg/m<sup>3</sup>

version pneumatic port  
Pressurized Center

Compressed air connection input  
Base plate ISO 5599-1

Flow conductance C  
4.3 l/(s\*bar)

Mounting screw  
with hexagon socket

Mounting screw tightening torque  
2 Nm

Weight  
0.21 kg

Housing material  
Aluminum

Seal material  
Acrylonitrile butadiene rubber

Part No.  
5811730100

## Dimensions

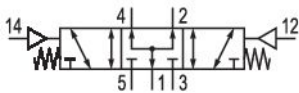
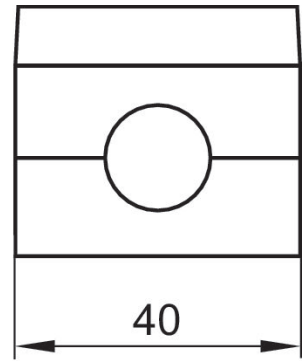
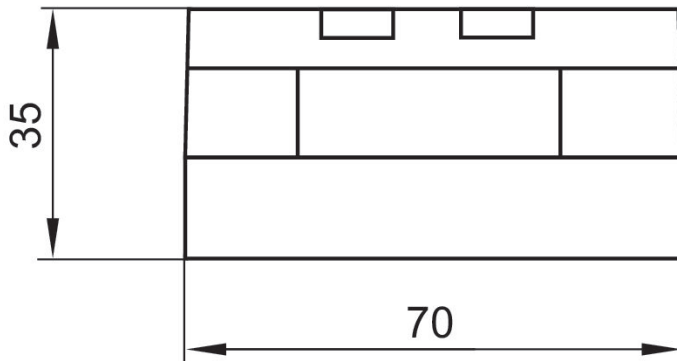



# 2x3/2-directional valve, Series 581, size 1

## 5811830100

ISO 5599-1, size 1, series 581

■  $Q_n = [[1400] \text{ l/min}]$



### Technical data

**Industry**  
Industrial

**Activation**  
Pneumatically

**Nominal flow  $Q_n$**   
950 l/min

**Compressed air connection output**  
Base plate ISO 5599-1

**Connection type**  
Plate connection

**Working pressure min.**  
0 bar

**Working pressure max**  
8 bar

**Sealing principle**  
Soft Seal

**ATEX**  
ATEX

II 2G Ex h IIC T6 Gb

II 2D Ex h IIIC T85°C Db IP65

**Standards**  
ISO 5599-1

**Valve type**  
Spool valve

**Version**  
ISO 1

**Can be assembled into blocks**  
Can be assembled into blocks

**Blocking principle**  
Single base plate principle

**Control pressure min.**  
3.5 bar

**Control pressure max.**  
8 bar

**Min. ambient temperature**  
-20 °C

**Max. ambient temperature**  
70 °C

**Min. medium temperature**  
-20 °C

Max. medium temperature  
70 °C

Medium  
Compressed air

Max. particle size  
50 µm

Oil content of compressed air min.  
0 mg/m<sup>3</sup>

Oil content of compressed air max.  
5 mg/m<sup>3</sup>

version pneumatic port  
NC/NC

Compressed air connection input  
Base plate ISO 5599-1

Flow conductance C  
4.2 l/(s\*bar)

Mounting screw  
with hexagon socket

Mounting screw tightening torque  
2 Nm

Weight  
0.21 kg

Housing material  
Aluminum

Seal material  
Acrylonitrile butadiene rubber

Part No.  
5811830100

## Dimensions

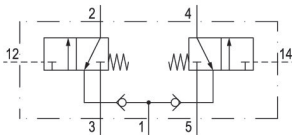
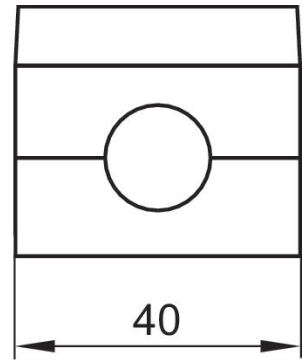
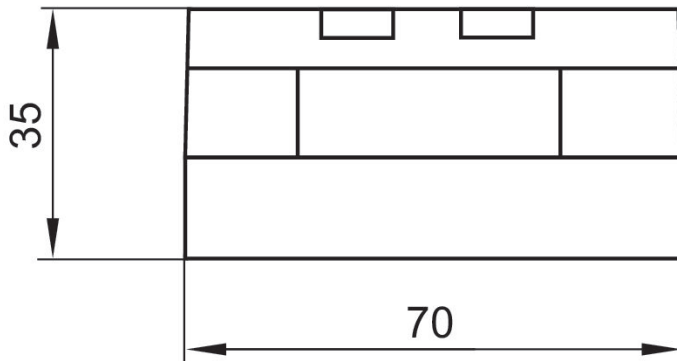

# Single subbase, thread connections on the side

- standard ISO 5599-1
- Frame size ISO 1
- Compressed air connection output G 1/4
- Reversed pressure supply permissible



Standards	ISO 5599-1
Working pressure min./max.	-0,95 ... 16 bar
Ambient temperature min./max.	-25 ... 70 °C
Medium temperature min./max.	-25 ... 70 °C
Medium	Compressed air
Number of valve positions max.	1
Grid dimension	48 mm
Direction of pneumatic port (1)	On the side
Direction of pneumatic port (3,5)	On the side
Direction of pneumatic port (2,4)	On the side
Direction of pneumatic port (12)	On the side
Direction of pneumatic port (14)	On the side
Exhaust (3,5)	With directional exhaust (3/5)
Exhaust type	Ports separated
Weight	0,17 kg

## Technical data

Part No.	Compressed air connection Input [1]	Compressed air connection Output [2 / 4]
1825503143	G 1/4	G 1/4

Part No.	Compressed air connection Exhaust [3 / 5]	Compressed air connection Pilot connection [12]
1825503143	G 1/4	G 1/8

Part No.	Compressed air connection Pilot control exhaust [R]
1825503143	G 1/8

## Technical information

The min. control pressure must be adhered to, since otherwise faulty switching and valve failure may result!  
 The pressure dew point must be at least 15 °C under ambient and medium temperature and may not exceed 3 °C .  
 The oil content of compressed air must remain constant during the life cycle.  
 Use only the approved oils from AVENTICS. Further information can be found in the "Technical information" document (available in the MediaCentre).

For use with HV series valves, the ambient temperature is -25 °C...200 °C and the medium temperature is -25 °C...120 °C.  
 Reversed pressure supply is not permitted for HV series valves.

## Technical information

Material

Base plate

Die-cast aluminum

## Dimensions

Fig. 1

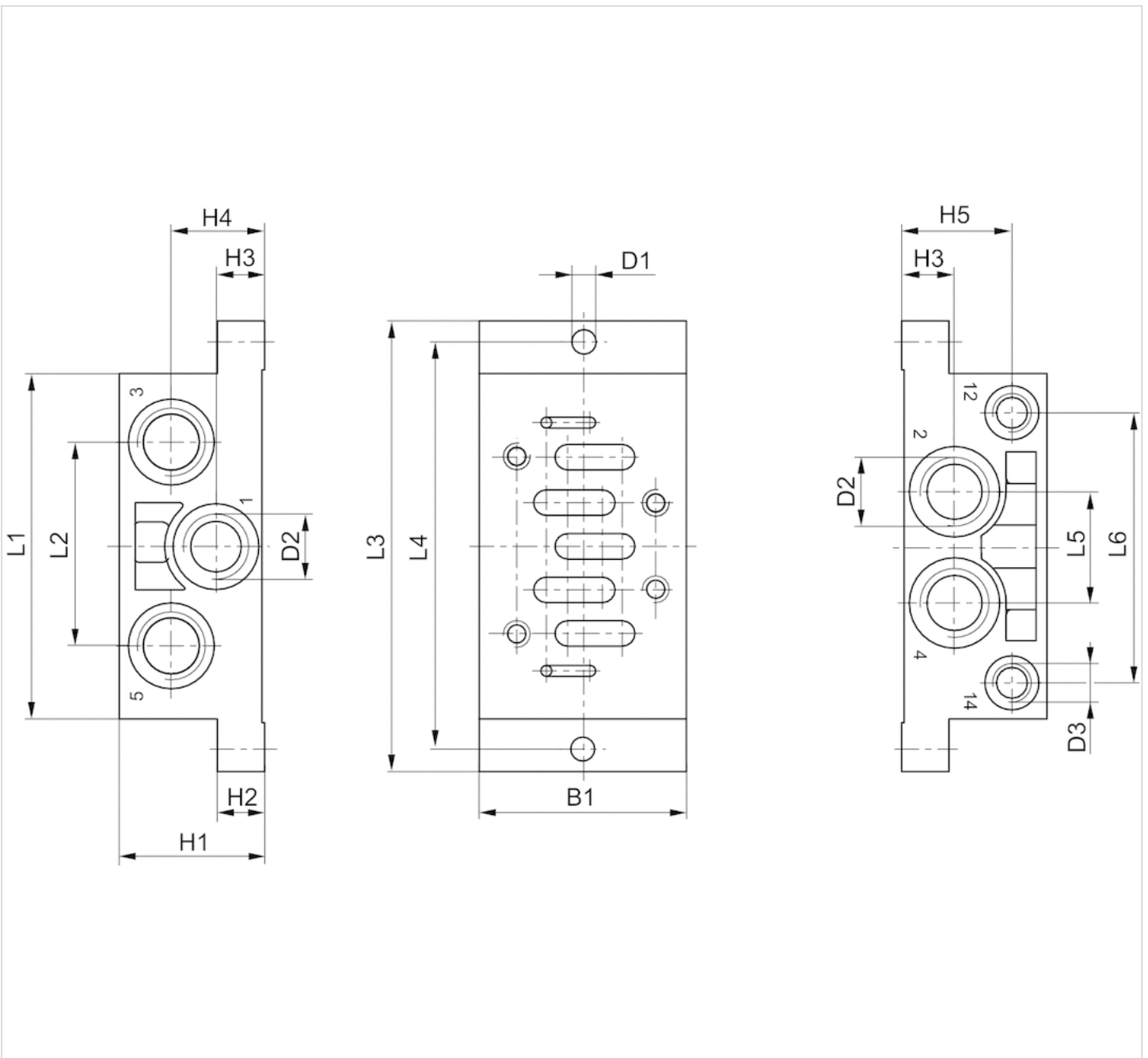

## Dimensions

Part No.	Frame size	B1	H1	H2	H3	H4	H5	D1	D2 *)	D3 *)	L1	L2	L3	L4	L5	L6
1825503143	ISO 1	48	32	10	11,5	21.5	23.5	5.5	G 1/4	G 1/8	84	43	110	98	24	58

\*) Ports

# Single subbase, thread connections on the bottom

- standard ISO 5599-1
- Frame size ISO 1
- Compressed air connection output G 1/4
- Reversed pressure supply permissible



Standards	ISO 5599-1
Working pressure min./max.	-0,95 ... 16 bar
Ambient temperature min./max.	-25 ... 70 °C
Medium temperature min./max.	-25 ... 70 °C
Medium	Compressed air
Number of valve positions max.	1
Direction of pneumatic port (1)	Down
Direction of pneumatic port (3,5)	Down
Direction of pneumatic port (2,4)	Down
Direction of pneumatic port (12)	Down
Direction of pneumatic port (14)	Down
Exhaust (3,5)	With directional exhaust (3/5)
Exhaust type	Ports separated
Weight	0,196 kg

## Technical data

Part No.	Compressed air connection Input [1]	Compressed air connection Output [2 / 4]
1825503201	G 1/4	G 1/4

Part No.	Compressed air connection Exhaust [3 / 5]	Compressed air connection Pilot connection [12]
1825503201	G 1/4	G 1/8

Part No.	Compressed air connection Pilot control exhaust [R]
1825503201	G 1/8

## Technical information

The min. control pressure must be adhered to, since otherwise faulty switching and valve failure may result!  
 The pressure dew point must be at least 15 °C under ambient and medium temperature and may not exceed 3 °C .  
 The oil content of compressed air must remain constant during the life cycle.  
 Use only the approved oils from AVENTICS. Further information can be found in the "Technical information" document (available in the MediaCentre).

For use with HV series valves, the ambient temperature is -25 °C...200 °C and the medium temperature is -25 °C...120 °C.  
 Reversed pressure supply is not permitted for HV series valves.

## Technical information

Material

Base plate

Die-cast aluminum

## Dimensions

Dimensions

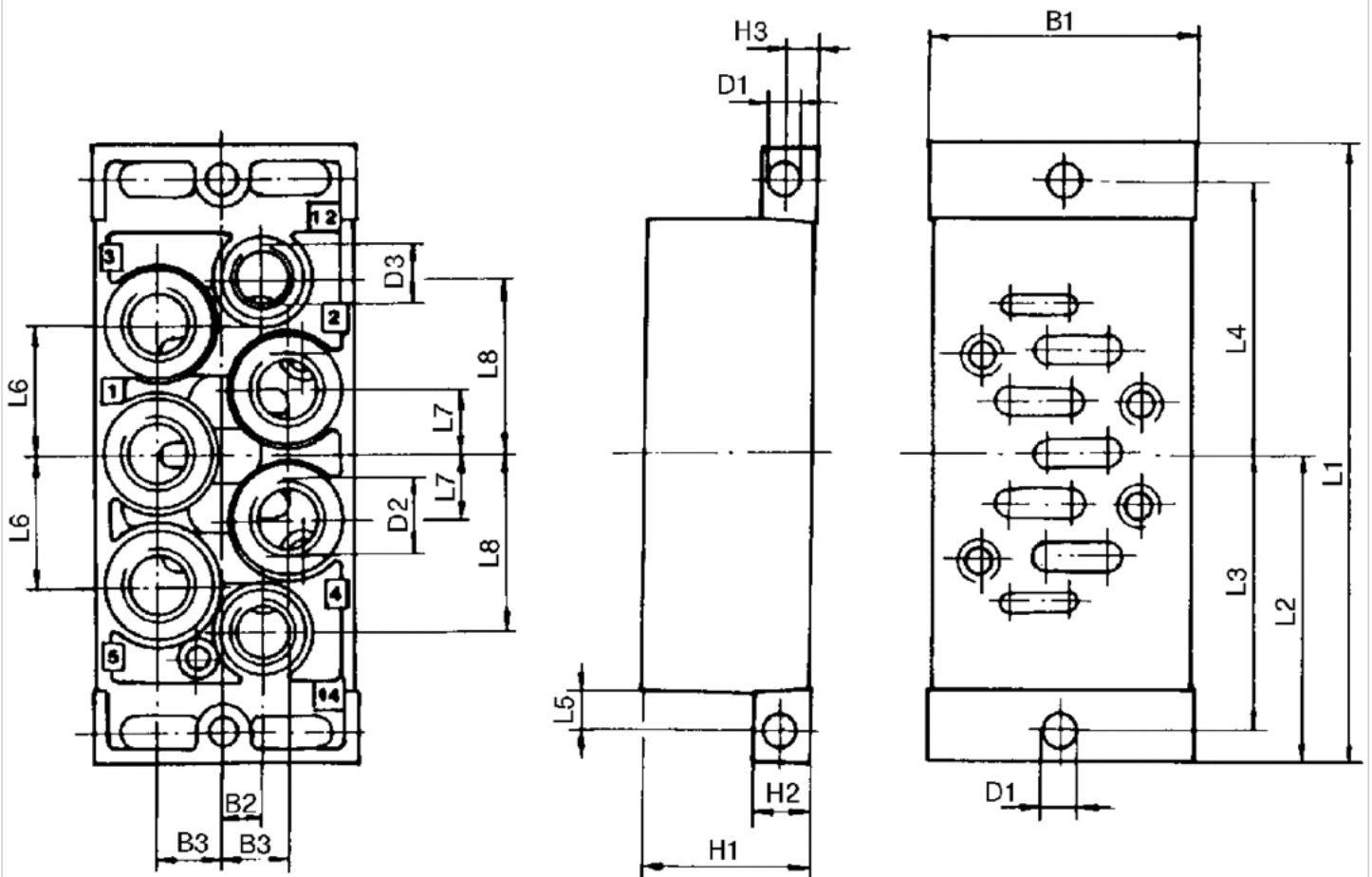

## Dimensions

Part No.	Frame size	B1	B2	B3	D1	D2 *)	D3 *)	H1	H2	H3	L1	L2	L3	L4	L5	L6	L7	L8
1825503201	ISO 1	46	7	11.5	5.5	G 1/4	G 1/8	30	10	5	110	55	49	49	7	23	11,5	31

\*) Ports



# Single subbase, ports on side

- standard ISO 5599-1
- Frame size ISO 1
- Compressed air connection output G 1/8 G 1/4



Standards	ISO 5599-1
Working pressure min./max.	-1 ... 16 bar
Ambient temperature min./max.	-20 ... 70 °C
Medium temperature min./max.	-20 ... 70 °C
Medium	Compressed air
Number of valve positions max.	1
Direction of pneumatic port (1)	On the side
Direction of pneumatic port (3,5)	On the side
Direction of pneumatic port (2,4)	On the side
Direction of pneumatic port (14)	On the side
Exhaust (3,5)	With directional exhaust (3/5)
Exhaust type	Ports separated
Weight	See table below

## Technical data

Part No.	Compressed air connection Input [1]	Compressed air connection Output [2 / 4]
5801710000	G 1/8	G 1/8
5801740000	G 1/4	G 1/4

Part No.	Compressed air connection Exhaust [3 / 5]	Compressed air connection Pilot connection [12]	Weight
5801710000	G 1/8	G 1/8	0,11 kg
5801740000	G 1/4	G 1/8	0,17 kg

## Technical information

The min. control pressure must be adhered to, since otherwise faulty switching and valve failure may result!  
 The pressure dew point must be at least 15 °C under ambient and medium temperature and may not exceed 3 °C .  
 The oil content of compressed air must remain constant during the life cycle.  
 Use only the approved oils from AVENTICS. Further information can be found in the "Technical information" document (available in the MediaCentre).

## Technical information

Material	
Base plate	Die-cast aluminum, black painted

## Dimensions

### Dimensions

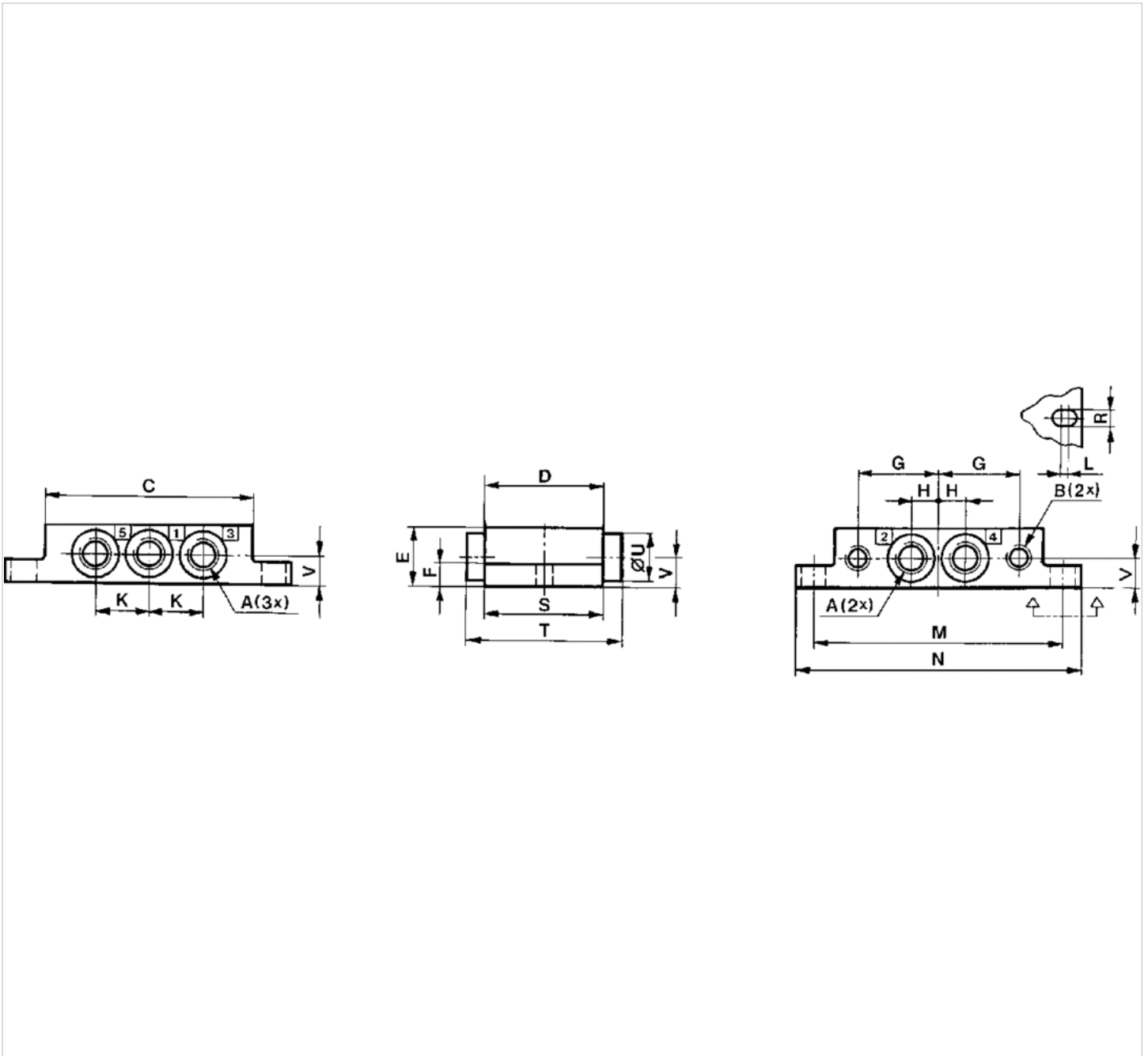

## Dimensions

Part No.	Frame size	A *)	B *)	C	D	E	F	G	H	K	L	M	N	R	S	T	U	V
5801710000	ISO 1	G 1/8	G 1/8	70	40	20	8	26.5	9	18	2	84	96	5.4	40	-	-	10
5801740000	ISO 1	G 1/4	G 1/8	70	40	23	11	31.5	11.5	23	2	96	110	5.4	46	64	21	12

\*) Ports

# Single subbase, ports on bottom

- standard ISO 5599-1
- Frame size ISO 1
- Compressed air connection output G 1/8



Standards	ISO 5599-1
Working pressure min./max.	-1 ... 16 bar
Ambient temperature min./max.	-20 ... 70 °C
Medium temperature min./max.	-20 ... 70 °C
Medium	Compressed air
Number of valve positions max.	1
Direction of pneumatic port (1)	Down
Direction of pneumatic port (3,5)	Down
Direction of pneumatic port (2,4)	Down
Direction of pneumatic port (14)	Down
Exhaust (3,5)	uncollected exhaust
Exhaust type	Ports separated
Weight	0,11 kg

## Technical data

Part No.	Compressed air connection Input [1]	Compressed air connection Output [2 / 4]
5801700000	G 1/8	G 1/8

Part No.	Compressed air connection Exhaust [3 / 5]	Compressed air connection Pilot connection [12]
5801700000	G 1/8	G 1/8

## Technical information

The min. control pressure must be adhered to, since otherwise faulty switching and valve failure may result!

The pressure dew point must be at least 15 °C under ambient and medium temperature and may not exceed 3 °C .

The oil content of compressed air must remain constant during the life cycle.

Use only the approved oils from AVENTICS. Further information can be found in the "Technical information" document (available in the MediaCentre).

## Technical information

Material	
Base plate	Die-cast aluminum, black painted

## Dimensions

### Dimensions

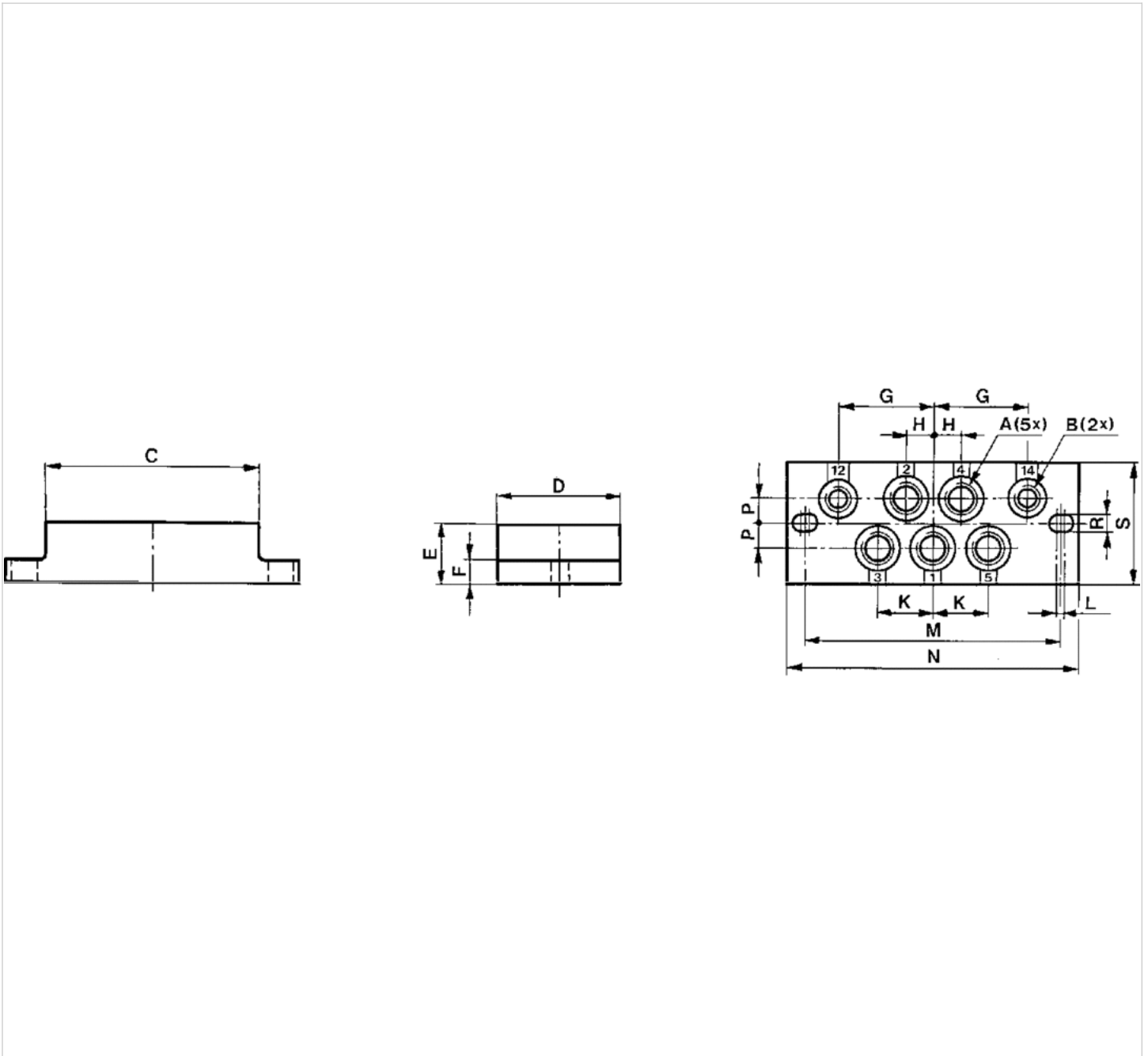

## Dimensions

Part No.	Frame size	A *)	B *)	C	D	E	F	G	H	K	L	M	N	P	R	S
5801700000	ISO 1	G1/8	G1/8	70	40	20	8	26.5	9	18	2	84	96	8	5.4	40

\*) Ports

# Subbase, for direct mounting of ISO valves on cylinders

- standard ISO 5599-1
- Frame size ISO 1
- Compressed air connection output G 1/8



Standards	ISO 5599-1
Working pressure min./max.	-1 ... 16 bar
Ambient temperature min./max.	-20 ... 70 °C
Medium temperature min./max.	-20 ... 70 °C
Medium	Compressed air
Weight	0,175 kg

## Technical data

Part No.	Compressed air connection Input [1]	Compressed air connection Output [2 / 4]
5801690000	G 1/8	G 1/8

Part No.	Compressed air connection Exhaust [3 / 5]	Compressed air connection Pilot connection [12]
5801690000	G 1/8	G 1/8

Scope of delivery incl. mounting screws

Ø 32 mm ... 125 mm

## Technical information

The min. control pressure must be adhered to, since otherwise faulty switching and valve failure may result!

The pressure dew point must be at least 15 °C under ambient and medium temperature and may not exceed 3 °C .

The oil content of compressed air must remain constant during the life cycle.

Use only the approved oils from AVENTICS. Further information can be found in the "Technical information" document (available in the MediaCentre).

## Technical information

Material	
Base plate	Die-cast aluminum, black anodized
Seal	Acrylonitrile butadiene rubber

## Dimensions

### Dimensions

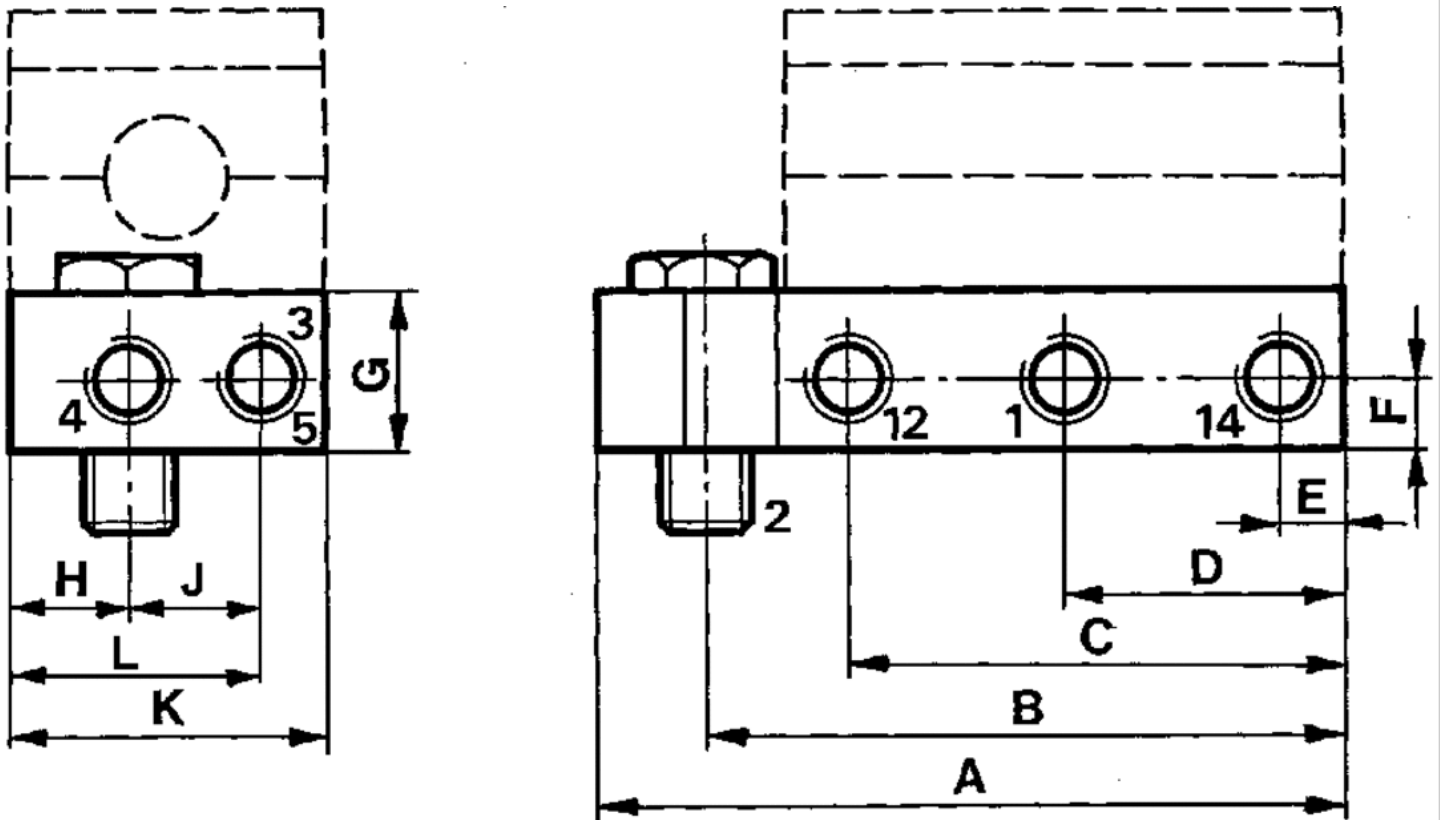

## Dimensions

Part No.	Frame size	1, 4, 3, (5)	2*	12, 14	A	B	C	D	E	F	G	H	J	K	L
5801690000	ISO 1	G 1/8	G 1/8, G 1/4	G 1/8	93.5	80	62	35	8	9	20	15	17	40	32

\* Two different threaded banjo bolts are supplied with 5801690000 to be used with different cylinders.

# Single subbase, for soft-start valve

- Compressed air connection output G 1/2



Working pressure min./max.	-1 ... 16 bar
Ambient temperature min./max.	-20 ... 70 °C
Medium temperature min./max.	-20 ... 70 °C
Medium	Compressed air
Number of valve positions max.	1
Exhaust (3,5)	uncollected exhaust
Exhaust type	Ports separated
Weight	0,34 kg

## Technical data

Part No.	Compressed air connection Input [1]	Compressed air connection Output [2 / 4]
5834710000	G 1/2	G 1/2

Part No.	Compressed air connection Exhaust [3 / 5]	Compressed air connection Pilot connection [12]
5834710000	G 1/2	G 1/8

## Technical information

The min. control pressure must be adhered to, since otherwise faulty switching and valve failure may result!  
 The pressure dew point must be at least 15 °C under ambient and medium temperature and may not exceed 3 °C .  
 The oil content of compressed air must remain constant during the life cycle.  
 Use only the approved oils from AVENTICS. Further information can be found in the "Technical information" document (available in the MediaCentre).

## Technical information

Material	
Base plate	Die-cast aluminum, black painted

Dimensions

Dimensions

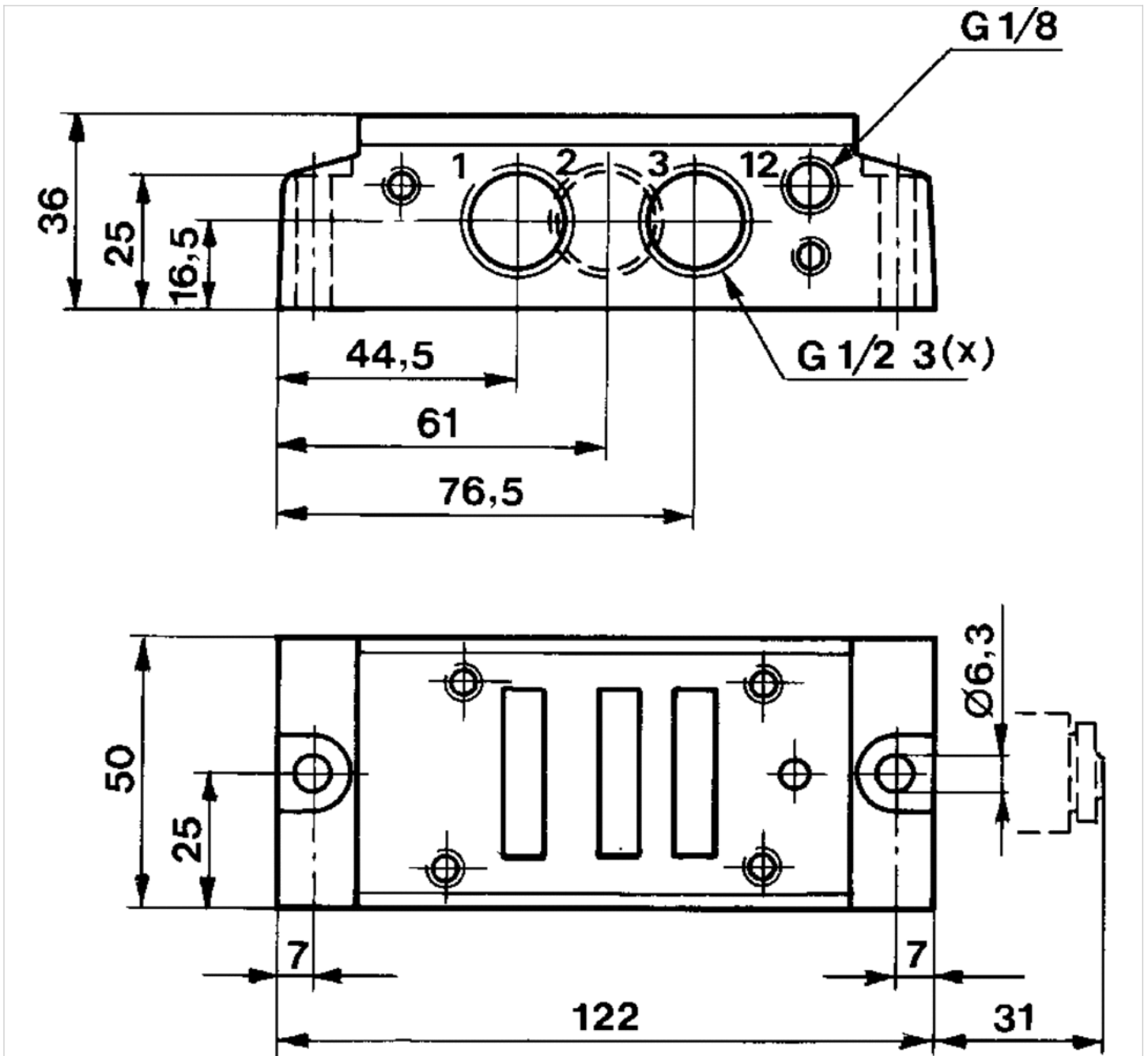



# End plate left, End plate right

- standard ISO 5599-1
- Frame size ISO 1
- type F
- Can be assembled into blocks
- Base plate principle, multiple
- Reversed pressure supply permissible



Standards	ISO 5599-1
Compressed air connection	according to ISO 5599-1
Working pressure min./max.	-0,95 ... 16 bar
Ambient temperature min./max.	-15 ... 70 °C
Medium temperature min./max.	-25 ... 70 °C
Medium	Compressed air
Direction of pneumatic port (1)	On the side
Direction of pneumatic port (3,5)	On the side
Exhaust (3,5)	With directional exhaust (3/5)
Exhaust type	Ports separated
Mounting screw	hexagon head
Weight	0,208 kg

## Technical data

Part No.	Compressed air connection Input [1]	Compressed air connection Exhaust [3 / 5]
1825503145	G 3/8	G 3/8

Scope of delivery: 2 end plates including seal and mounting screws

## Technical information

The min. control pressure must be adhered to, since otherwise faulty switching and valve failure may result!  
 The pressure dew point must be at least 15 °C under ambient and medium temperature and may not exceed 3 °C .  
 The oil content of compressed air must remain constant during the life cycle.  
 Use only the approved oils from AVENTICS. Further information can be found in the "Technical information" document (available in the MediaCentre).

## Technical information

Material	
Base plate	Die-cast aluminum
Seal	Acrylonitrile butadiene rubber

## Dimensions

### Dimensions

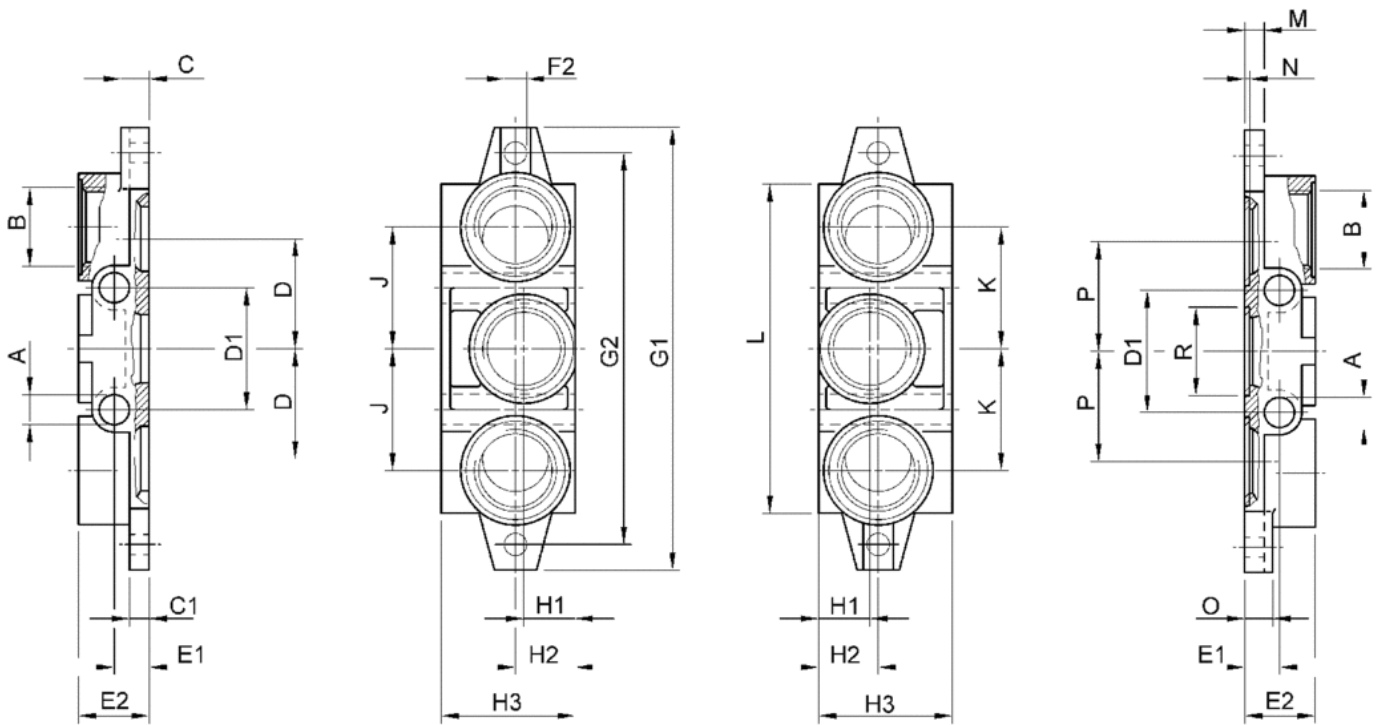

## Dimensions

Part No.	A	B	C	C1	D	D1	E1	E2	F2	G1	G2	H1	H2	H3	J	K	L	M	N	O	P	R
1825503145	7	G 3/8	8	6	24	28	11	22	Ø 5,5	110	95	22	22	46	28	28	85	6	2	8	24	Ø 22,1

# Base plate, ports 2 and 4 on bottom

- standard ISO 5599-1
- Frame size ISO 1
- type F
- Compressed air connection output G 1/4
- Can be assembled into blocks
- Single base plate principle
- Reversed pressure supply permissible
- With collective pilot air exhaust



Standards	ISO 5599-1
Compressed air connection	according to ISO 5599-1
Working pressure min./max.	-0,95 ... 16 bar
Ambient temperature min./max.	-25 ... 70 °C
Medium temperature min./max.	-25 ... 70 °C
Medium	Compressed air
Number of valve positions max.	1
Grid dimension	43 mm
Direction of pneumatic port (1)	On the side
Direction of pneumatic port (3,5)	On the side
Direction of pneumatic port (2,4)	Down
Direction of pneumatic port (12)	On the side
Direction of pneumatic port (14)	On the side
Exhaust (3,5)	With directional exhaust (3/5)
Exhaust type	Ports separated
Mounting screw	hexagon head
Weight	0,246 kg

## Technical data

Part No.	Compressed air connection Output [2 / 4]	Compressed air connection Pilot connection [12]
1825503144	G 1/4	G 1/8

Part No.	Compressed air connection Pilot control exhaust [R]
1825503144	G 1/8

Scope of delivery incl. seal and mounting screws

## Technical information

The min. control pressure must be adhered to, since otherwise faulty switching and valve failure may result!  
 The pressure dew point must be at least 15 °C under ambient and medium temperature and may not exceed 3 °C .  
 The oil content of compressed air must remain constant during the life cycle.  
 Use only the approved oils from AVENTICS. Further information can be found in the "Technical information" document (available in the MediaCentre).

## Technical information

Material	
Housing	Die-cast aluminum
Base plate	Die-cast aluminum
Seal	Acrylonitrile butadiene rubber

## Dimensions

### Dimensions

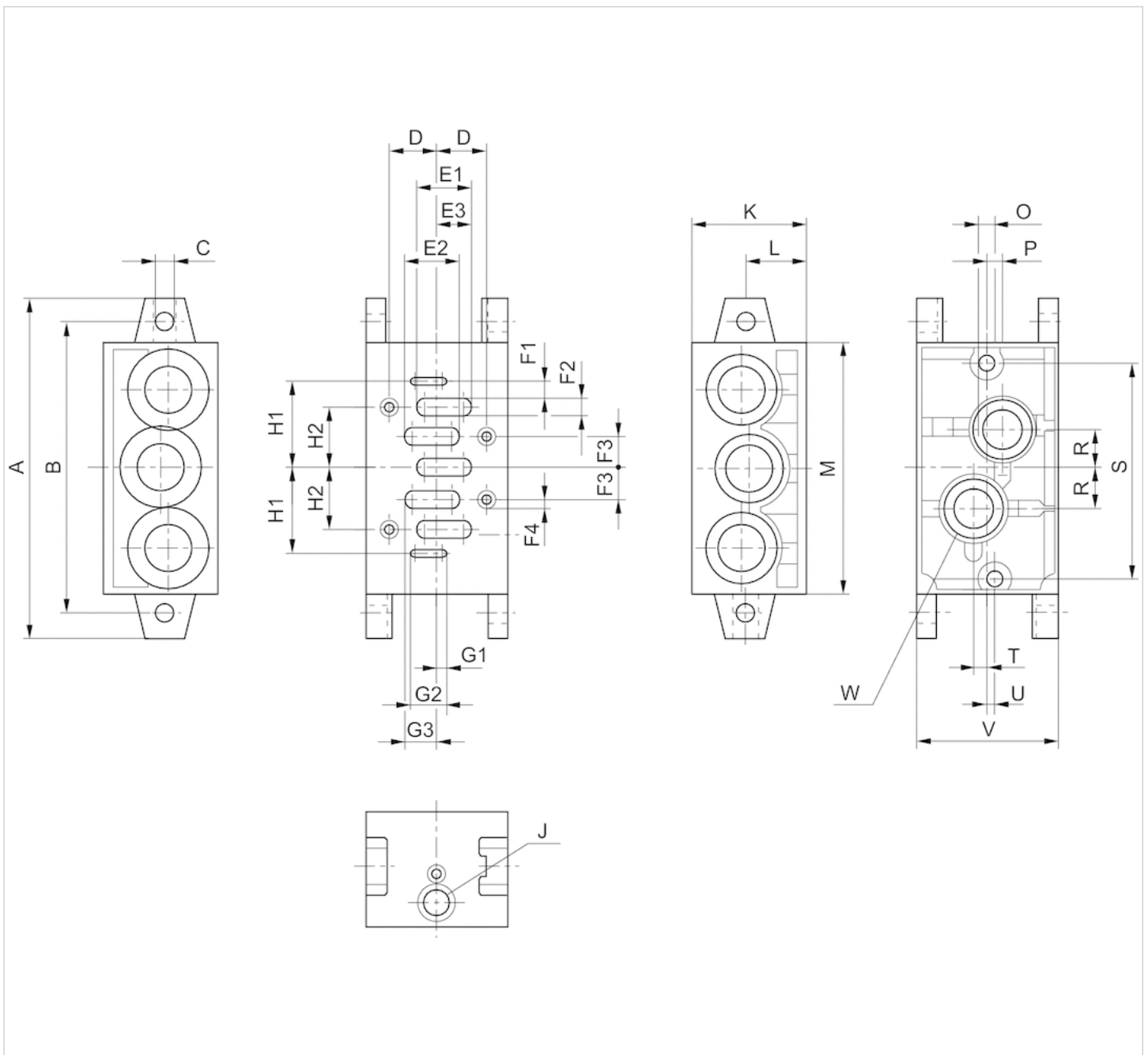

## Dimensions

Part No.	A	B	C	D	E1	E2	E3	F1	F2	F3	F4	G1	G2	G3	H1	H2	J	K	L	M	O
1825503144	110	95	5,5	14	16,5	16,5	11,25	3	4,5	9	M5	3	13,5	11,25	26,5	18	G 1/8	44	22	85	M5
P	R		S		T		U		V		W										
7,5	13		71		1,5		3		43		G 1/4										

# Transition plate

- standard ISO 5599-1
- Frame size ISO 1 ▶ ISO 3 ISO 2 ▶ ISO 3
- type F
- Can be assembled into blocks
- Reversed pressure supply permissible



Standards	ISO 5599-1
Working pressure min./max.	-0,95 ... 16 bar
Ambient temperature min./max.	-15 ... 70 °C
Medium temperature min./max.	-15 ... 80 °C
Medium	Compressed air
Exhaust (3,5)	uncollected exhaust
Exhaust type	Ports separated
Mounting screw	hexagon head
Weight	See table below

## Technical data

Part No.	Frame size	Weight	Fig.
1825503166	ISO 1 ▶ ISO 3	0,825 kg	Fig. 1
1825503165	ISO 2 ▶ ISO 3	0,79 kg	Fig. 2

## Technical information

The min. control pressure must be adhered to, since otherwise faulty switching and valve failure may result!  
 The pressure dew point must be at least 15 °C under ambient and medium temperature and may not exceed 3 °C .  
 The oil content of compressed air must remain constant during the life cycle.  
 Use only the approved oils from AVENTICS. Further information can be found in the "Technical information" document (available in the MediaCentre).

## Technical information

Material	
Housing	Aluminum
Base plate	Aluminum
Seal	Acrylonitrile butadiene rubber

# Dimensions

Fig. 1

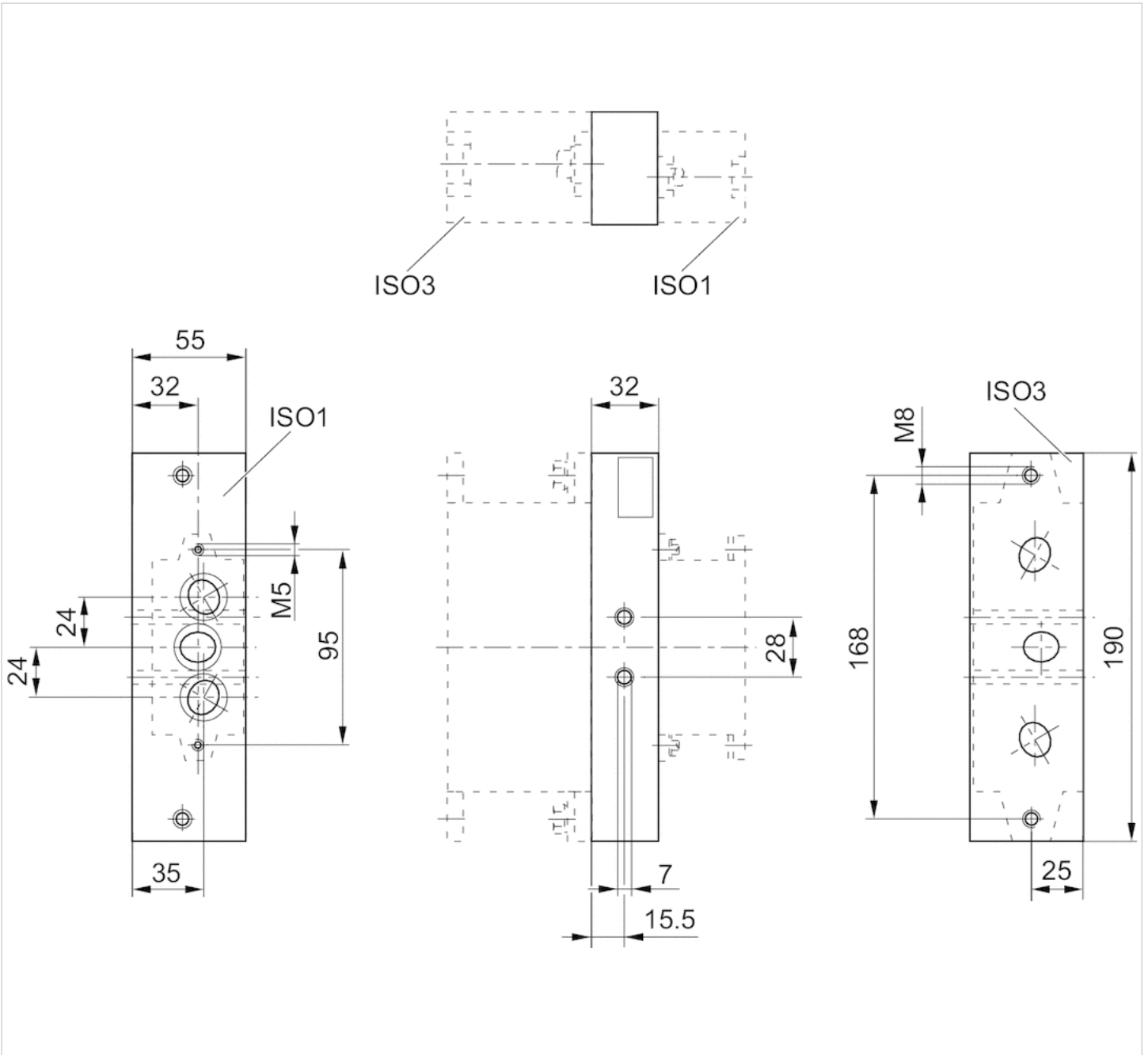
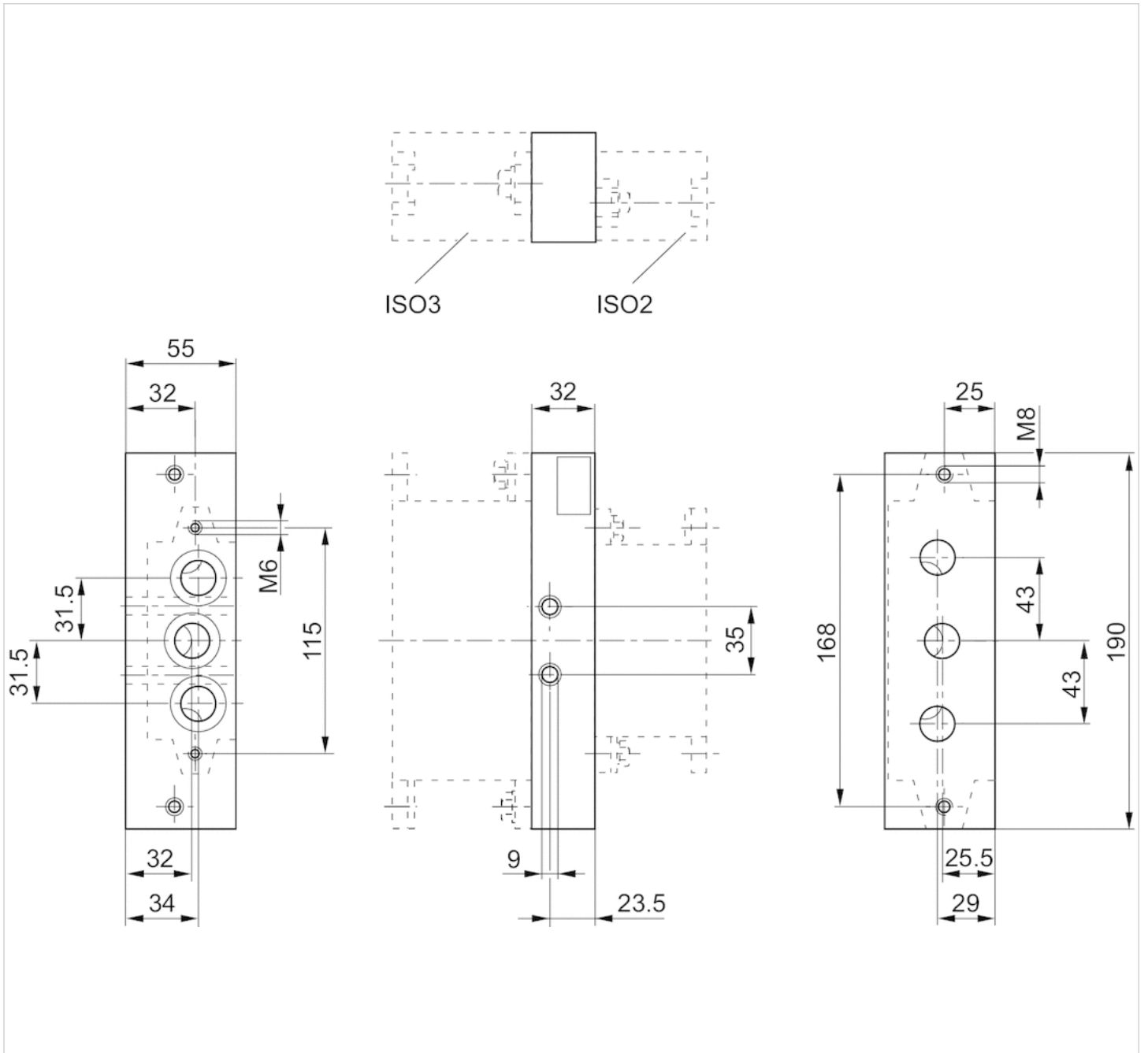

Fig. 2





# Transition plate

- standard ISO 5599-1
- Frame size ISO 1 ▶ ISO 2
- type F
- Can be assembled into blocks
- Reversed pressure supply permissible



Standards	ISO 5599-1
Working pressure min./max.	-0,95 ... 16 bar
Ambient temperature min./max.	-15 ... 70 °C
Medium temperature min./max.	-15 ... 80 °C
Medium	Compressed air
Exhaust (3,5)	uncollected exhaust
Exhaust type	Ports separated
Mounting screw	hexagon head
Weight	0,295 kg

## Technical data

Part No.

1825503164

## Technical information

The min. control pressure must be adhered to, since otherwise faulty switching and valve failure may result!  
 The pressure dew point must be at least 15 °C under ambient and medium temperature and may not exceed 3 °C .  
 The oil content of compressed air must remain constant during the life cycle.  
 Use only the approved oils from AVENTICS. Further information can be found in the "Technical information" document (available in the MediaCentre).

## Technical information

### Material

Housing	Aluminum
Base plate	Aluminum
Seal	Acrylonitrile butadiene rubber

# Dimensions

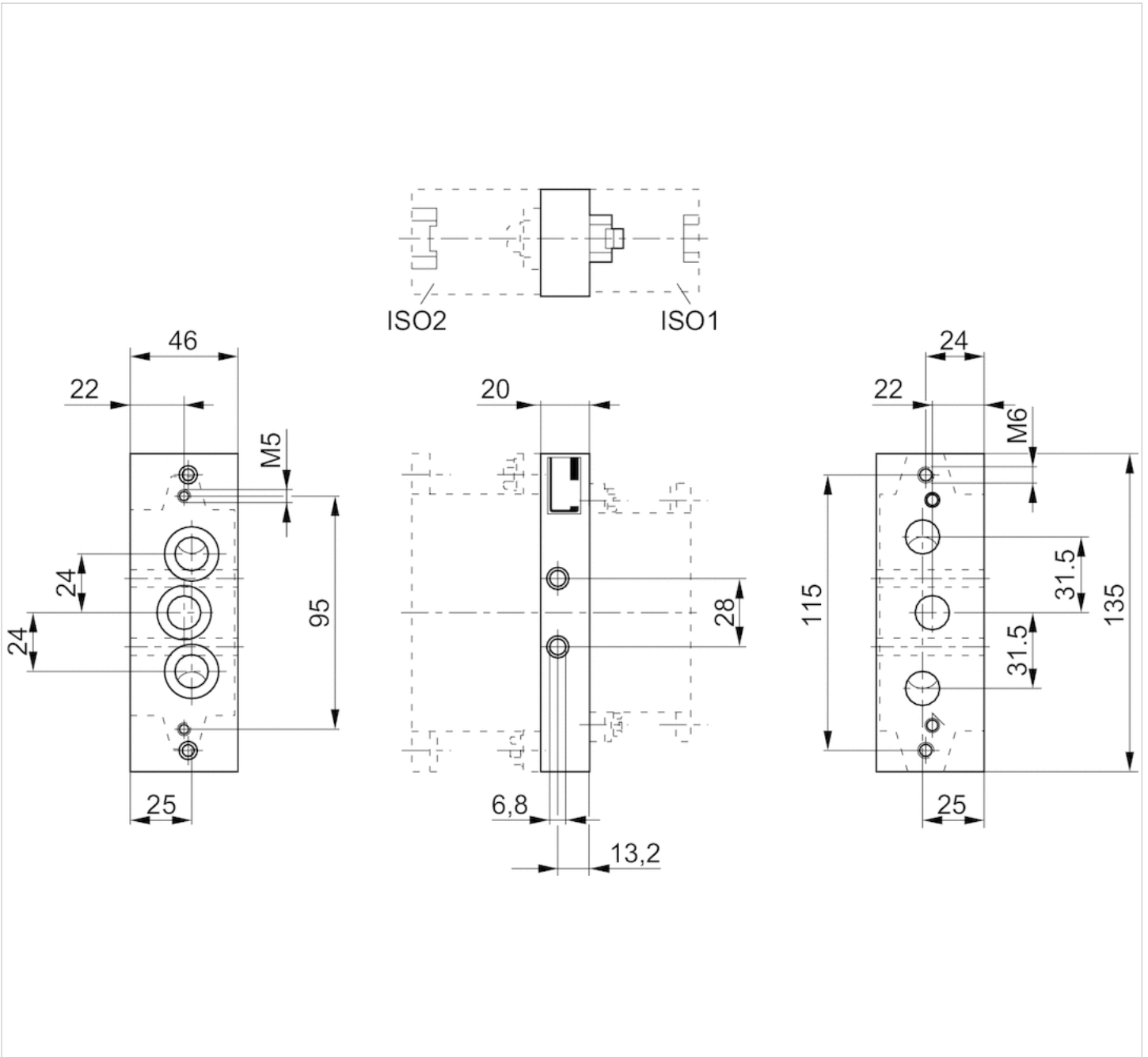

# End plates for adapter plate

- standard ISO 5599-1
- Frame size ISO 1, ISO 2 ISO 1, ISO 3 ISO 2, ISO 3
- type F
- Can be assembled into blocks
- Reversed pressure supply permissible



Standards	ISO 5599-1
Working pressure min./max.	-0,95 ... 16 bar
Ambient temperature min./max.	-15 ... 70 °C
Medium temperature min./max.	-15 ... 80 °C
Medium	Compressed air
Direction of pneumatic port (1)	On the side
Direction of pneumatic port (3,5)	On the side
Exhaust (3,5)	With directional exhaust (3/5)
Exhaust type	Ports separated
Mounting screw	hexagon head
Weight	See table below

## Technical data

Part No.	Frame size	Weight
1825503244	ISO 1, ISO 2	0,255 kg
1825503243	ISO 1, ISO 3	0,395 kg
1825503245	ISO 2, ISO 3	0,45 kg

Scope of delivery: 2 end plates of different sizes including seal and mounting screws

## Technical information

The min. control pressure must be adhered to, since otherwise faulty switching and valve failure may result!  
 The pressure dew point must be at least 15 °C under ambient and medium temperature and may not exceed 3 °C .  
 The oil content of compressed air must remain constant during the life cycle.  
 Use only the approved oils from AVENTICS. Further information can be found in the "Technical information" document (available in the MediaCentre).

## Technical information

Material	
Base plate	Die-cast aluminum
Seal	Acrylonitrile butadiene rubber

# Dimensions

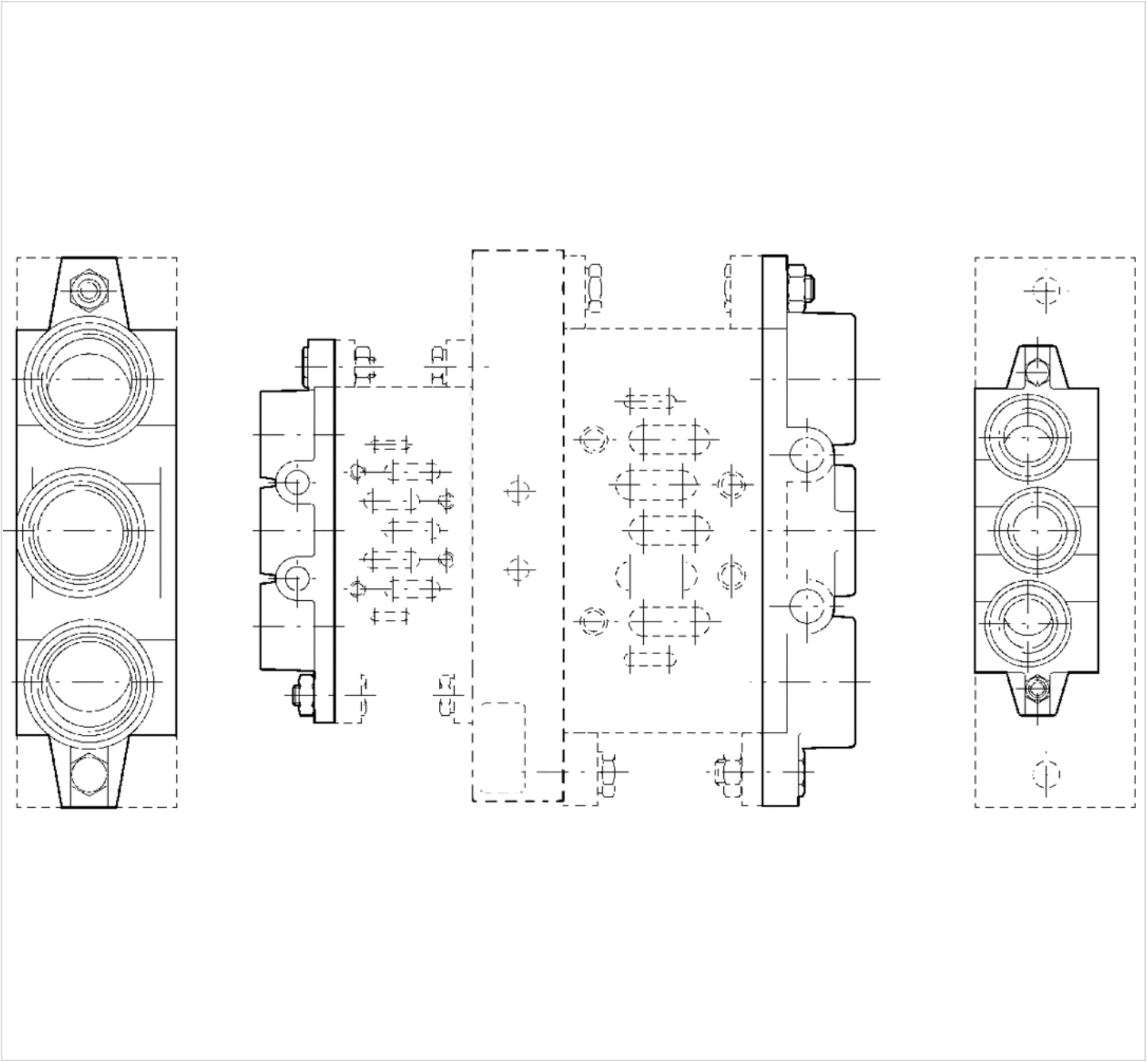

Dimensions

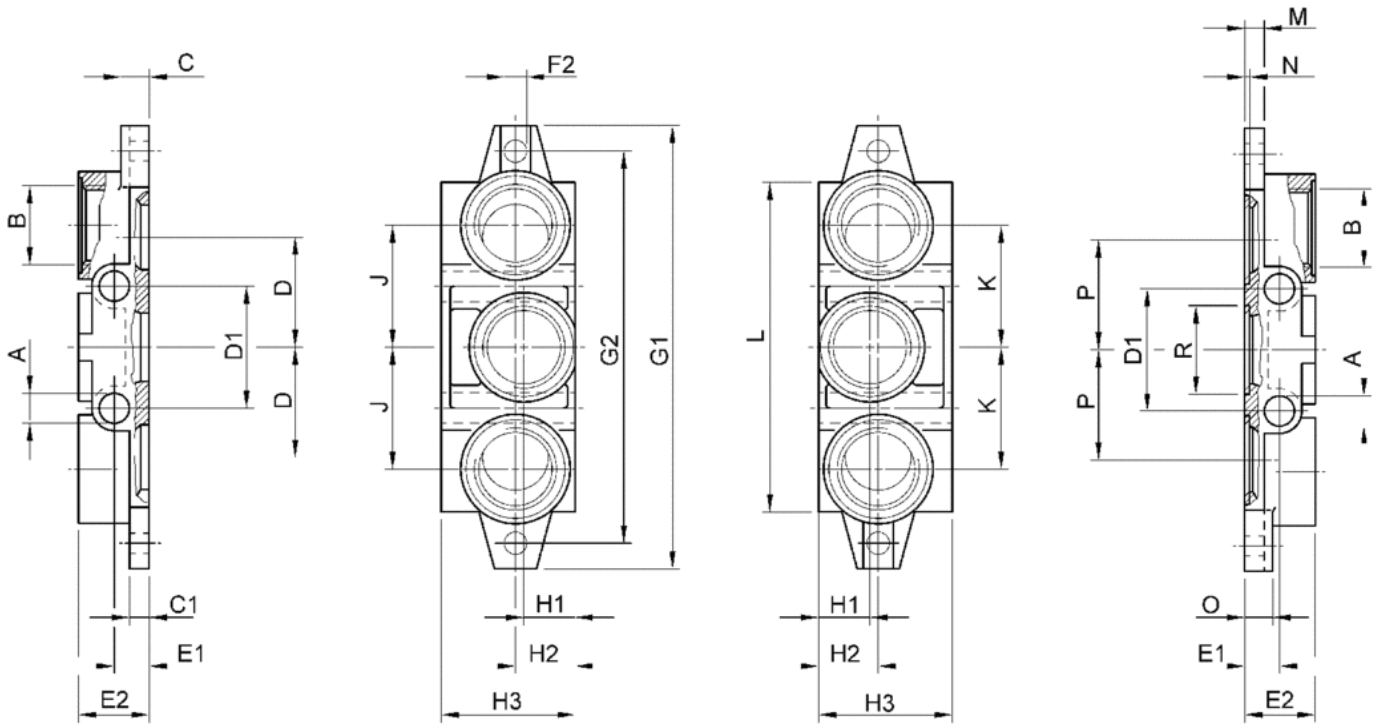

Dimensions

	ISO 1	ISO 2	ISO 3
A	7	9	12
B	G 3/8	G 1/2	G 1
C	8	11	12
C1	6	8	8
D	24	31,5	47
D1	28	35	52
E1	11	13	15
E2	22	26	32
F2	Ø 5,5	Ø 6,6	Ø 9
G1	110	135	190

	ISO 1	ISO 2	ISO 3
G2	95	115	168
H1	22	23	22
H2	22	24	25
H3	46	47	56
J	28	34	52
K	28	34	52
L	85	100	140
M	6	8	8
N	2	2	2,7
O	8	11	12
P	24	31,5	47
R	Ø 22,1	Ø 28,7	Ø 38

# Angle subplate

- standard ISO 5599-1
- Frame size ISO 1 ISO 2 ISO 3
- type F
- Compressed air connection output G 1/4 G 3/8 G 1/2



Standards	ISO 5599-1
Working pressure min./max.	0 ... 10 bar
Ambient temperature min./max.	-15 ... 80 °C
Medium temperature min./max.	-15 ... 80 °C
Medium	Compressed air
Direction of pneumatic port (2,4)	On the side
Mounting screw	with hexagon socket
Weight	See table below

## Technical data

Part No.	Frame size	Compressed air connection Output [2 / 4]	Weight
1825503170	ISO 1	G 1/4	0,413 kg
1825503204	ISO 2	G 3/8	0,688 kg
1825503205	ISO 3	G 1/2	1,4 kg

## Technical information

The min. control pressure must be adhered to, since otherwise faulty switching and valve failure may result!  
 The pressure dew point must be at least 15 °C under ambient and medium temperature and may not exceed 3 °C .  
 The oil content of compressed air must remain constant during the life cycle.  
 Use only the approved oils from AVENTICS. Further information can be found in the "Technical information" document (available in the MediaCentre).

## Technical information

Material	
Base plate	Aluminum
Seal	Acrylonitrile butadiene rubber

## Dimensions

### Dimensions

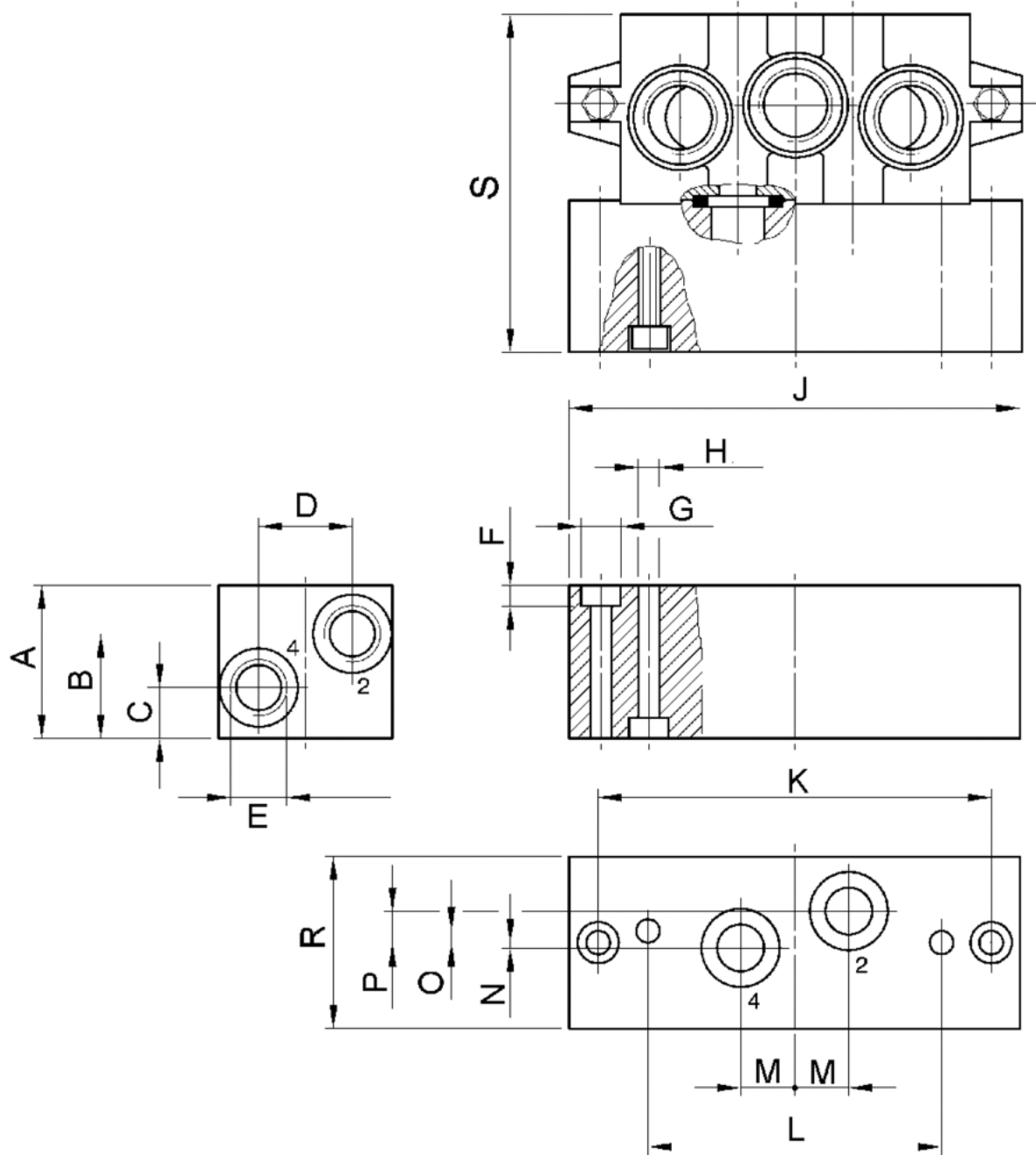

## Dimensions

Part No.	A	B	C	D	E	F	G	H	J	K	L	M	N	O	P	R	S
1825503170	37	25	12	22	G 1/4	5,7	Ø 10	Ø 5,5	110	95	71	13	1,5	3	7,5	42	81
1825503204	40	26	14	29	G 3/8	6,8	Ø 11	Ø 6,6	135	115	86	15	5	3	6	55	85
1825503205	45	29	17	36	G 1/2	9	Ø 15	Ø 9	190	168	130	19	6	3	8	70	99



# Supply plate

- standard ISO 5599-1
- Frame size ISO 1
- type F
- Reversed pressure supply permissible



Standards	ISO 5599-1
Working pressure min./max.	-0,95 ... 16 bar
Ambient temperature min./max.	-25 ... 70 °C
Medium temperature min./max.	-25 ... 70 °C
Medium	Compressed air
Direction of pneumatic port (1)	Down
Direction of pneumatic port (3,5)	Down
Exhaust type	Ports separated
Mounting screw	hexagon head
Weight	0,395 kg

## Technical data

Part No.	Compressed air connection Input [1]	Compressed air connection Exhaust [3 / 5]
8985041162	G 3/8	G 3/8

Scope of delivery incl. seal and mounting screws

## Technical information

The min. control pressure must be adhered to, since otherwise faulty switching and valve failure may result!  
 The pressure dew point must be at least 15 °C under ambient and medium temperature and may not exceed 3 °C .  
 The oil content of compressed air must remain constant during the life cycle.  
 Use only the approved oils from AVENTICS. Further information can be found in the "Technical information" document (available in the MediaCentre).

## Technical information

Material	
Base plate	Aluminum
Seal	Acrylonitrile butadiene rubber

## Dimensions

### Dimensions

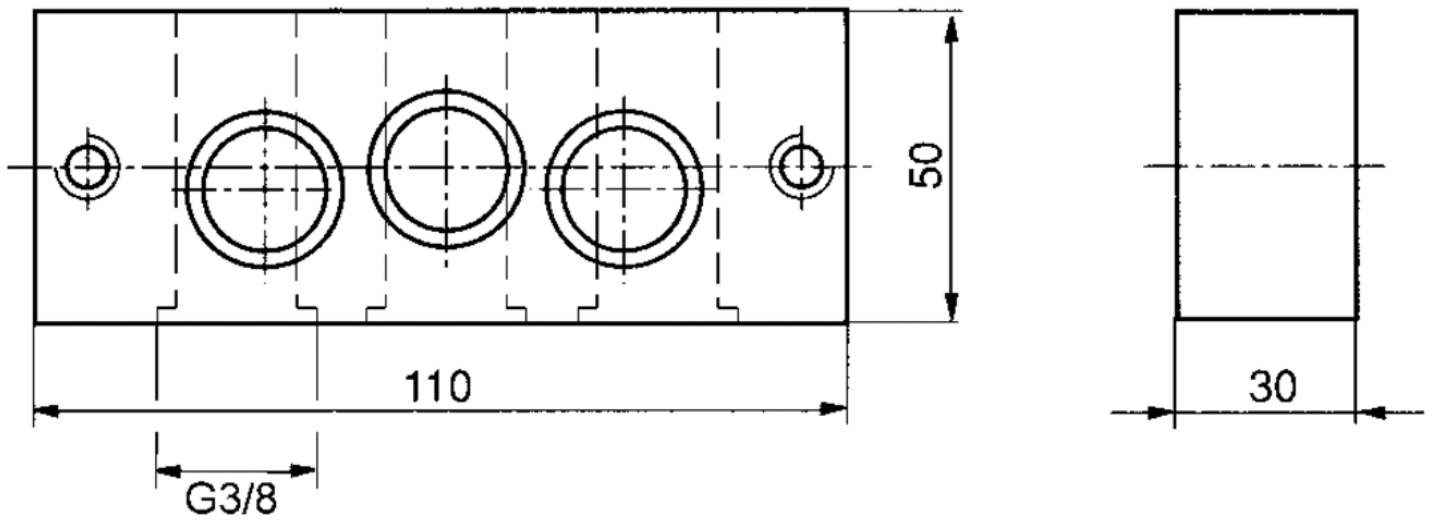

# Blanking piece, Subbases ISO 5599-1

- standard ISO 5599-1, ISO 1 ISO 5599-1, ISO 2 ISO 5599-1, ISO 3

- type F



Standards

ISO 5599-1

Working pressure min./max.

-0,95 ... 10 bar

Ambient temperature min./max.

-25 ... 70 °C

## Technical data

Part No.	Accessory type	Frame size
8985049012	type F	ISO 1
8985049022	type F	ISO 2
8985049032	type F	ISO 3

## Technical information

Material	
Housing	Brass
Seal	Acrylonitrile butadiene rubber

## Dimensions

## Dimensions

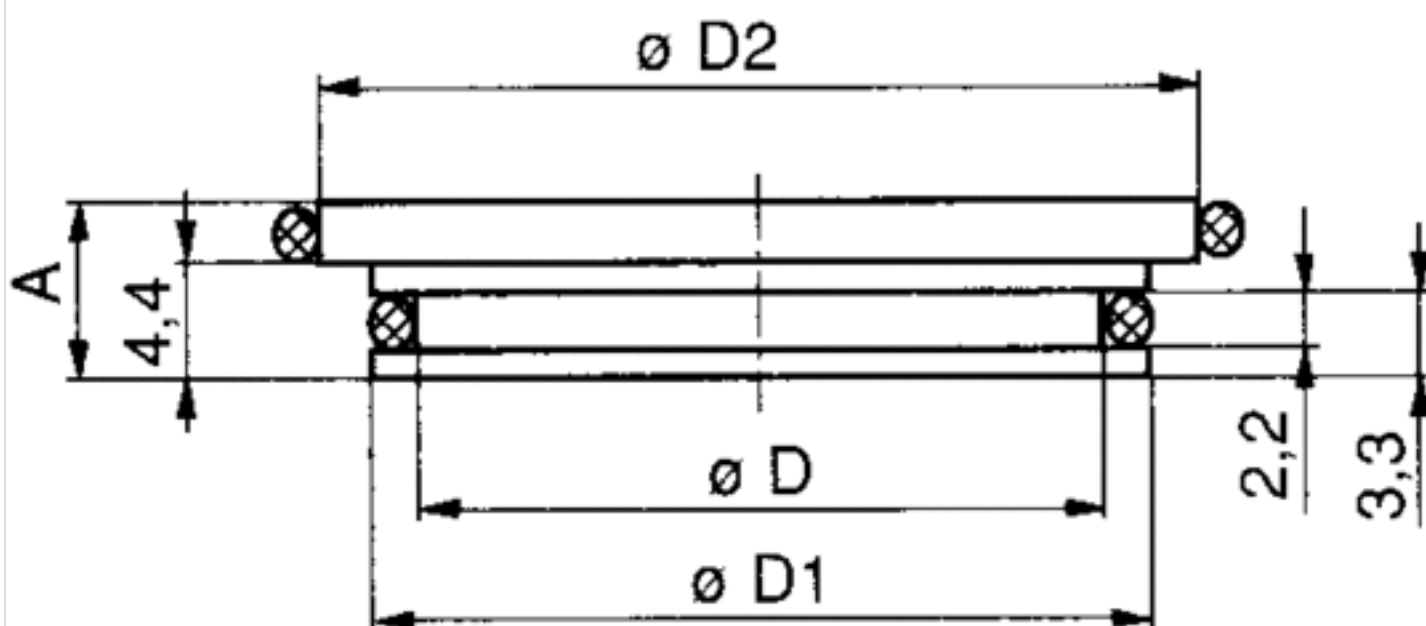

## Dimensions

Part No.	Frame size	A	D	D1	D2
8985049012	ISO 1	6.2	12.2	14.8	16.5
8985049022	ISO 2	6.2	15.7	18.3	23
8985049032	ISO 3	6.9	25.1	27.7	30

# Accessories, for intermediate plates

- standard ISO 5599-1, ISO 1

- type F



Standards

ISO 5599-1

## Technical data

Part No.	Type	Accessory type	Frame size	Delivery unit
1827009767	Mounting screw	type F	ISO 1	10 piece
R412000918	O-ring, Ø 17 mm, 12x2,62	type F	ISO 1	50 piece

# End plate right

- standard ISO 5599-1
- Frame size ISO 1 ISO 2 ISO 3
- type C



Standards	ISO 5599-1
Working pressure min./max.	-0,95 ... 16 bar
Ambient temperature min./max.	-15 ... 70 °C
Medium temperature min./max.	-15 ... 70 °C
Medium	Compressed air
Weight	See table below

## Technical data

Part No.	Frame size	Compressed air connection Input [1]	Compressed air connection Exhaust [3 / 5]	Weight
R432037651	ISO 1	G 3/8	G 3/8	0,32 kg
R432037653	ISO 2	G 3/4	G 3/4	0,491 kg
R432037655	ISO 3	G 1	G 1	1,32 kg

Scope of delivery incl. seal and mounting screws

## Technical information

The min. control pressure must be adhered to, since otherwise faulty switching and valve failure may result!  
 The pressure dew point must be at least 15 °C under ambient and medium temperature and may not exceed 3 °C .  
 The oil content of compressed air must remain constant during the life cycle.  
 Use only the approved oils from AVENTICS. Further information can be found in the "Technical information" document (available in the MediaCentre).

## Technical information

Material	
Surface	painted
Base plate	Die-cast aluminum, black painted
Seal	Acrylonitrile butadiene rubber

## Dimensions

### Dimensions

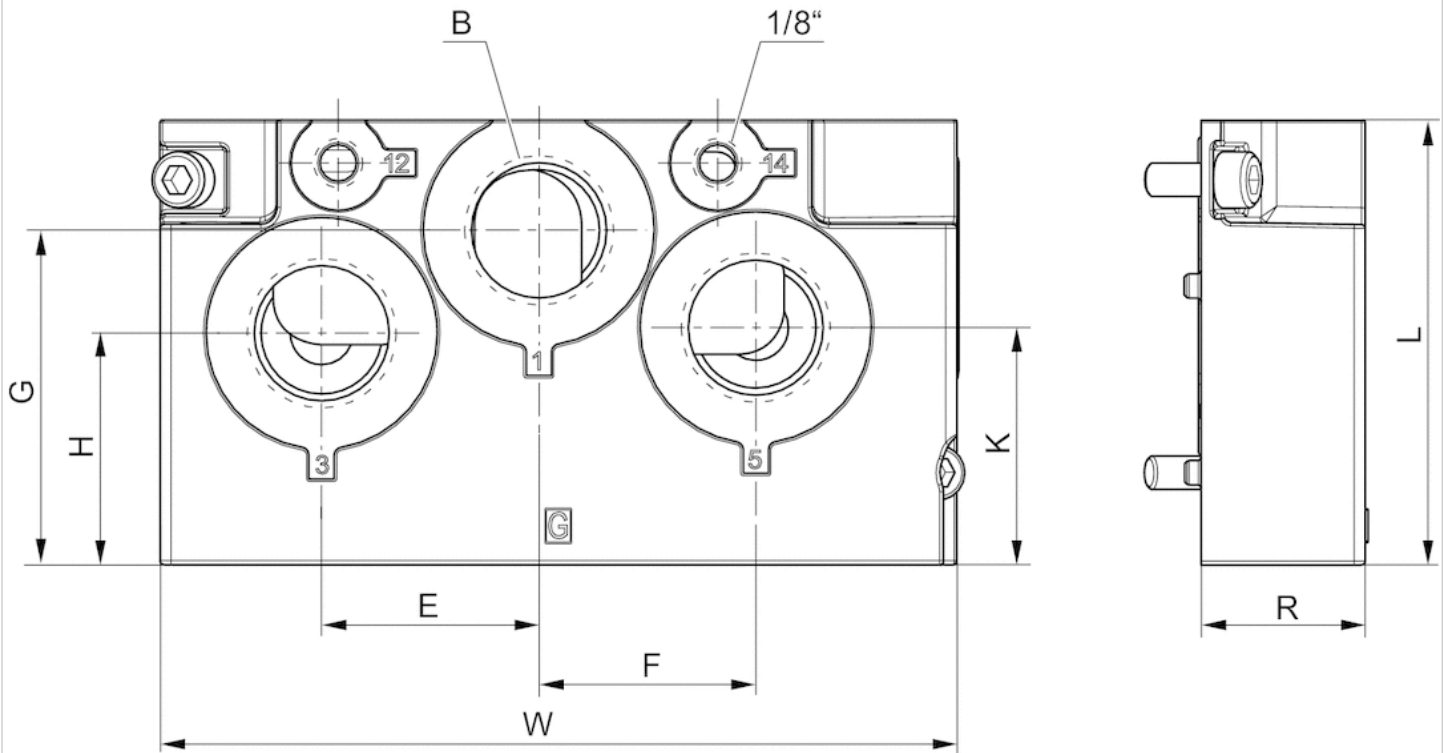

## Dimensions

Part No.	Frame size	B	E	F	G	H	J	K	R	L	W
R432037651	ISO 1	3/8	23	18	15.5	30	20	37.5	25	60.6	135
R432037653	ISO 2	3/4	39	39	60	41.5	38	42.5	29.5	79.7	143
R432037655	ISO 3	1	49	49	76	53	32	53	36	100	164

# Base plate

- standard ISO 5599-1
- Frame size ISO 1 ISO 2 ISO 3
- type C
- Compressed air connection output G 3/8 G 1/2 G 3/4
- Can be assembled into blocks



Standards	ISO 5599-1
Working pressure min./max.	-1 ... 16 bar
Ambient temperature min./max.	-20 ... 70 °C
Medium temperature min./max.	-20 ... 70 °C
Medium	Compressed air
Direction of pneumatic port (1)	Both directions possible
Direction of pneumatic port (3,5)	Both directions possible
Exhaust type	Ports separated
Weight	See table below

## Technical data

Part No.	Frame size	Compressed air connection Output [2 / 4]	Weight
R432037639	ISO 1	G 3/8	0,592 kg
R432037641	ISO 2	G 1/2	1,04 kg
R432037643	ISO 3	G 3/4	1,89 kg

Scope of delivery incl. seal and mounting screws

## Technical information

The min. control pressure must be adhered to, since otherwise faulty switching and valve failure may result!

The pressure dew point must be at least 15 °C under ambient and medium temperature and may not exceed 3 °C .

The oil content of compressed air must remain constant during the life cycle.

Use only the approved oils from AVENTICS. Further information can be found in the "Technical information" document (available in the MediaCentre).

## Technical information

Material	
Surface	Painted
Base plate	Die-cast aluminum, black painted
Seal	Acrylonitrile butadiene rubber



## Dimensions

### Dimensions

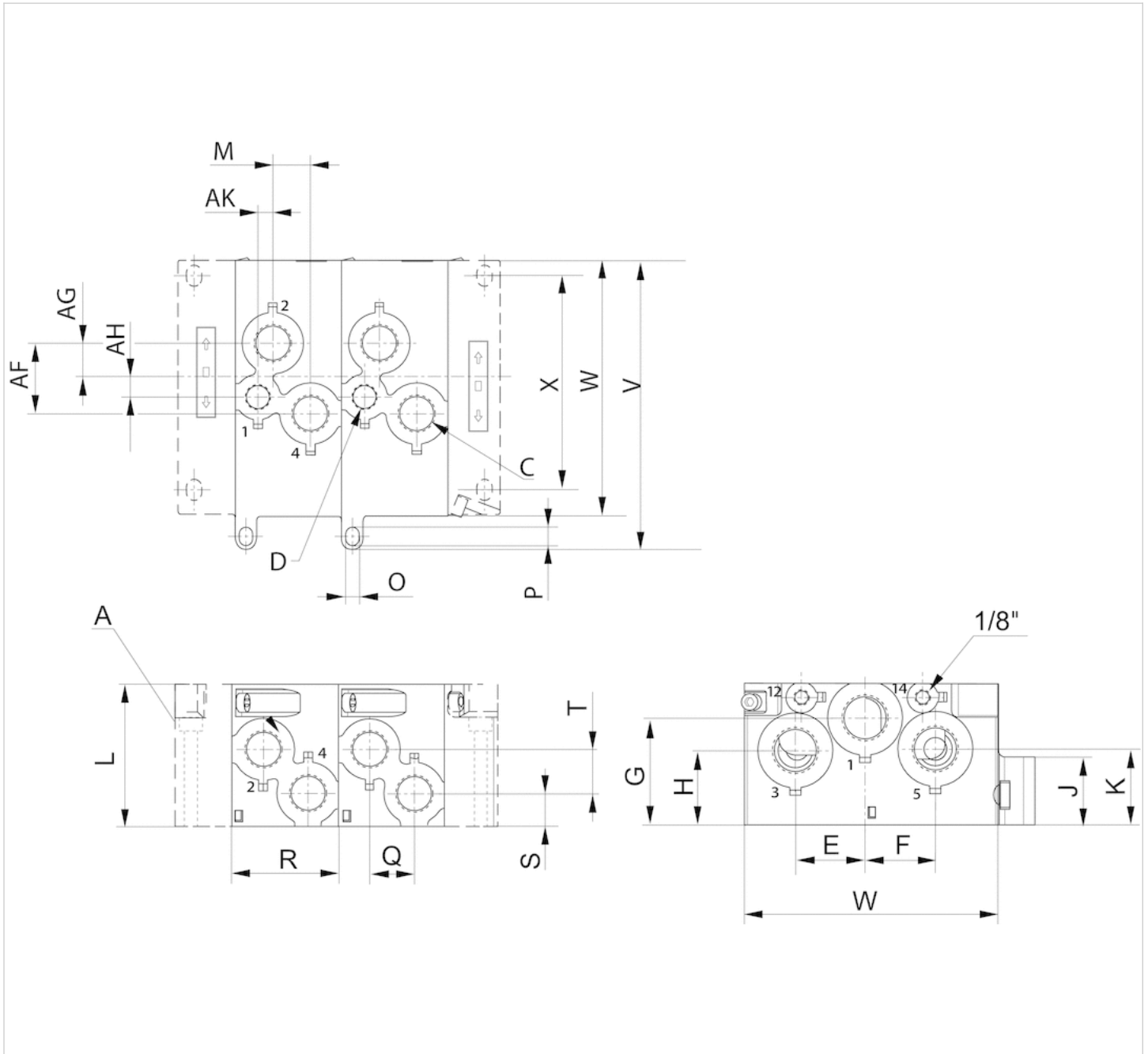

A = left and right end plates in two versions

## Dimensions

Part No.	A	D	C	AF	AG	AH	AK	E	F	G	H	J	K	L	M	O	P	R
R432037639	G 1/4	-	G 3/8	23.8	11.8	-	-	23	18	15,5	30	20	37,5	60.6	12	5.5	8.5	45
R432037641	G 1/2	G 3/8	G 1/2	39.5	19	11	8.2	39	39	60	41,5	38	42,5	79.7	21	5.5	9.3	59.5
R432037643	G 3/4	G 1/2	G 3/4	46.3	25.1	11.2	15.8	49	49	76	53	32	53	100	22.5	6.3	9.3	80

Q	S	T	X	W	V
18	13.3	14.7	102,5	135	150

Q	S	T	X	W	V
25	18	24.8	119,6	143	162,5
38	24.5	20.5	99	164	183

# End plate left

- standard ISO 5599-1
- Frame size ISO 1 ISO 2 ISO 3
- type C



Standards	ISO 5599-1
Working pressure min./max.	-0,95 ... 16 bar
Ambient temperature min./max.	-15 ... 70 °C
Medium temperature min./max.	-15 ... 70 °C
Medium	Compressed air
Weight	See table below

## Technical data

Part No.	Frame size	Compressed air connection Input [1]	Compressed air connection Exhaust [3 / 5]	Weight
R432037645	ISO 1	G 3/8	G 3/8	0,309 kg
R432037647	ISO 2	G 3/4	G 3/4	0,509 kg
R432037649	ISO 3	G 1	G 1	1,31 kg

Scope of delivery incl. seal and mounting screws

## Technical information

The min. control pressure must be adhered to, since otherwise faulty switching and valve failure may result!  
 The pressure dew point must be at least 15 °C under ambient and medium temperature and may not exceed 3 °C .  
 The oil content of compressed air must remain constant during the life cycle.  
 Use only the approved oils from AVENTICS. Further information can be found in the "Technical information" document (available in the MediaCentre).

## Technical information

Material	
Base plate	Die-cast aluminum
Seal	Acrylonitrile butadiene rubber

## Dimensions

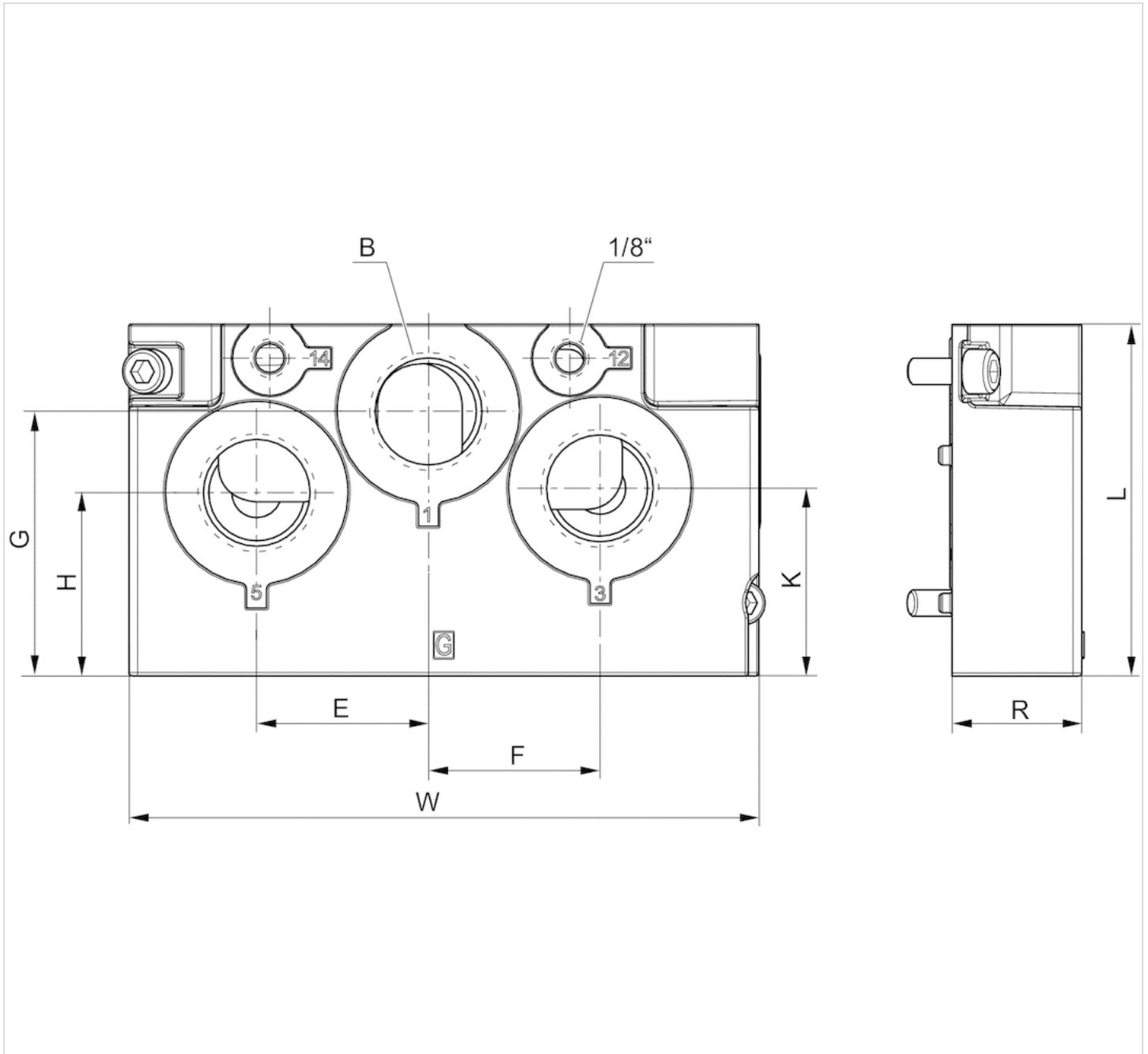

## Dimensions

Part No.	Frame size	B	E	F	G	H	J	K	L	R	W
R432037645	ISO 1	3/8	23	18	15.5	30	20	37.5	60.6	25	135
R432037647	ISO 2	3/4	39	39	60	41.5	38	42.5	79.7	32	143
R432037649	ISO 3	1	49	49	76	53	32	53	100	37	164

# Blanking piece

- according to ISO 5599
- standard ISO 1 ISO 2 ISO 3
- type C



Weight

See table below

## Technical data

Part No.	Type	Accessory type	Frame size	Weight
R432038306	Blanking piece	type C	ISO 1	0,009 kg
R432037662	Blanking piece	type C	ISO 2	0,009 kg
R432037663	Blanking piece	type C	ISO 3	0,02 kg

# Base plate, ports 2 and 4 on bottom

- standard ISO 5599-1
- Frame size ISO 1
- type K
- Compressed air connection output G 1/8 G 1/4
- Can be assembled into blocks



Standards	ISO 5599-1
Working pressure min./max.	-1 ... 16 bar
Ambient temperature min./max.	-20 ... 70 °C
Medium temperature min./max.	-20 ... 70 °C
Medium	Compressed air
Number of valve positions max.	1
Direction of pneumatic port (2,4)	Down
Exhaust (3,5)	uncollected exhaust
Exhaust type	Ports separated
Weight	See table below

An example configuration is illustrated.  
The delivered product may thus deviate from the illustration.

## Technical data

Part No.	Compressed air connection Output [2 / 4]	Compressed air connection Pilot connection [12]	Weight	
5801720000	G 1/8	G 1/8	0,14 kg	-
5801750000	G 1/4	G 1/8	0,27 kg	1)

Scope of delivery incl. seal and mounting screws

1) Suitable for Mecproof cabinet mounting

## Technical information

The min. control pressure must be adhered to, since otherwise faulty switching and valve failure may result!

The pressure dew point must be at least 15 °C under ambient and medium temperature and may not exceed 3 °C .

The oil content of compressed air must remain constant during the life cycle.

Use only the approved oils from AVENTICS. Further information can be found in the "Technical information" document (available in the MediaCentre).

## Technical information

Material	
Base plate	Die-cast aluminum, black painted
Seal	Acrylonitrile butadiene rubber

## Dimensions

### Dimensions

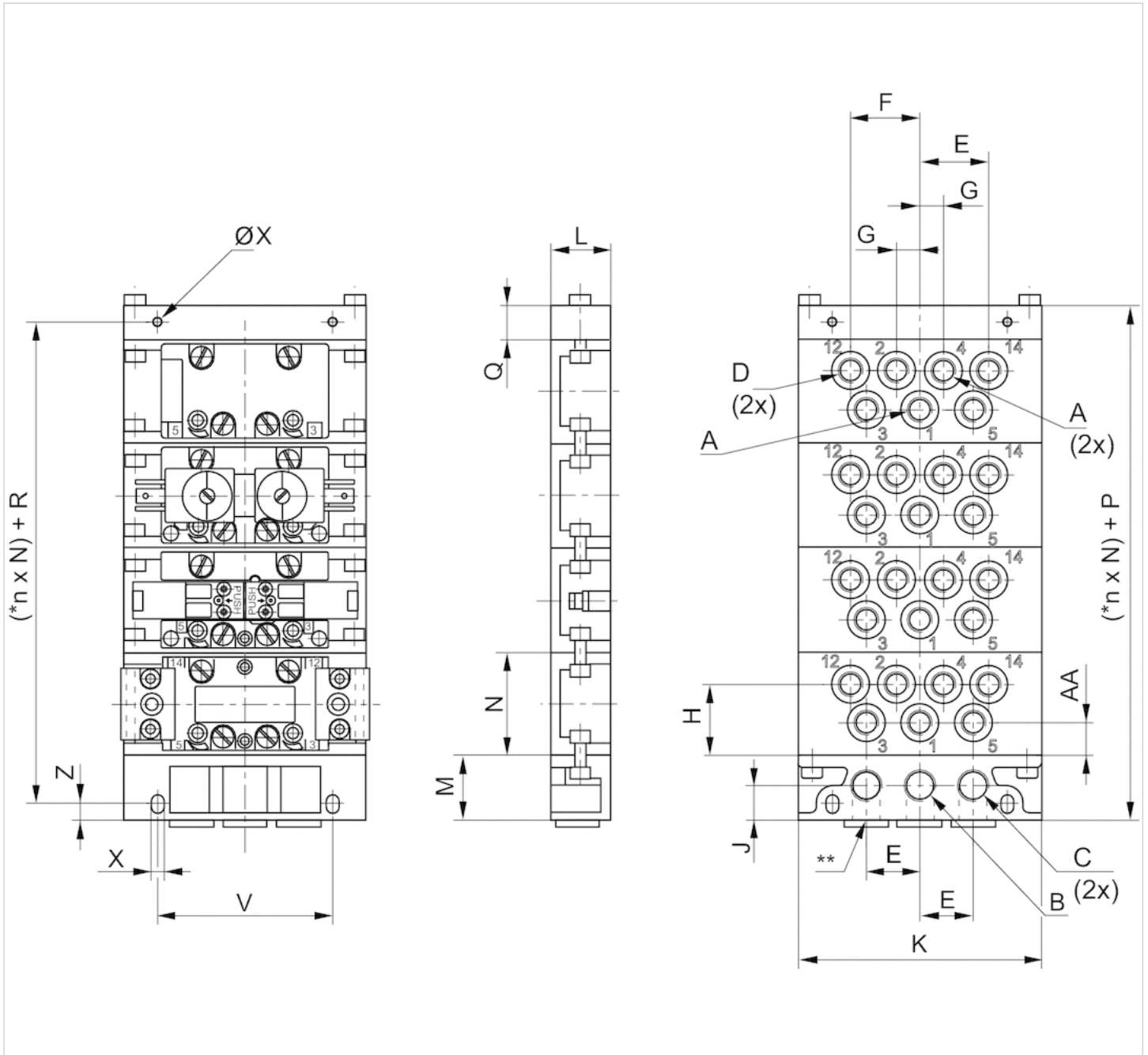

\* n = Number of subbases.

\*\* Alternative port openings, closed with plugs

## Dimensions

Part No.	*		A	B	C	D	E	F	G	H	J	K	L	M	N	P	Q	R	V
5801720000	a	ISO 1	G 1/8	G 1/4	G 1/4	G 1/8	22	28.5	9.5	29.5	14.5	100	25	27	43	41	14	27.5	72
5801750000	b	ISO 1	G 1/4	G 3/8	G 3/8	G 1/8	27	40	12.5	26.5	20	122	30	34	43	49	15	34	94

X	Z	AA
5.4	7	8

X	Z	AA
6.4	8	10

\* Intermediate plates designated with the same letters (a-d) can be mounted together without a transition plate.



# Intermediate plate for separate air supply, ports 2 and 4 on bottom

- standard ISO 5599-1
- Frame size ISO 1
- type K
- Compressed air connection output G 1/8 G 1/4
- Can be assembled into blocks



Standards	ISO 5599-1
Working pressure min./max.	-1 ... 16 bar
Ambient temperature min./max.	-20 ... 70 °C
Medium temperature min./max.	-20 ... 70 °C
Medium	Compressed air
Number of valve positions max.	1
Direction of pneumatic port (1)	Down
Direction of pneumatic port (3,5)	Down
Direction of pneumatic port (2,4)	Down
Direction of pneumatic port (14)	Down
Exhaust (3,5)	uncollected exhaust
Exhaust type	Ports separated
Weight	See table below

An example configuration is illustrated. The delivered product may thus deviate from the illustration.

## Technical data

Part No.	Type	Compressed air connection Input [1]
5801670000	Intermediate plate for separate air supply	G 1/8
5801680000	Intermediate plate for separate air supply	G 1/4

Part No.	Compressed air connection Output [2 / 4]	Compressed air connection Pilot connection [12]	Port	Weight
5801670000	G 1/8	G 1/8	-	0,14 kg
5801680000	G 1/4	G 1/8	G 1/4	0,27 kg

Part No.	Part No.
5801670000	-
5801680000	1)

Scope of delivery incl. seal and mounting screws

1) Suitable for Mecproof cabinet mounting

## Technical information

The min. control pressure must be adhered to, since otherwise faulty switching and valve failure may result!

The pressure dew point must be at least 15 °C under ambient and medium temperature and may not exceed 3 °C .

The oil content of compressed air must remain constant during the life cycle.

Use only the approved oils from AVENTICS. Further information can be found in the "Technical information" document (available in the MediaCentre).

## Technical information

Material	
Base plate	Die-cast aluminum, black painted
Seal	Acrylonitrile butadiene rubber

## Dimensions

### Dimensions

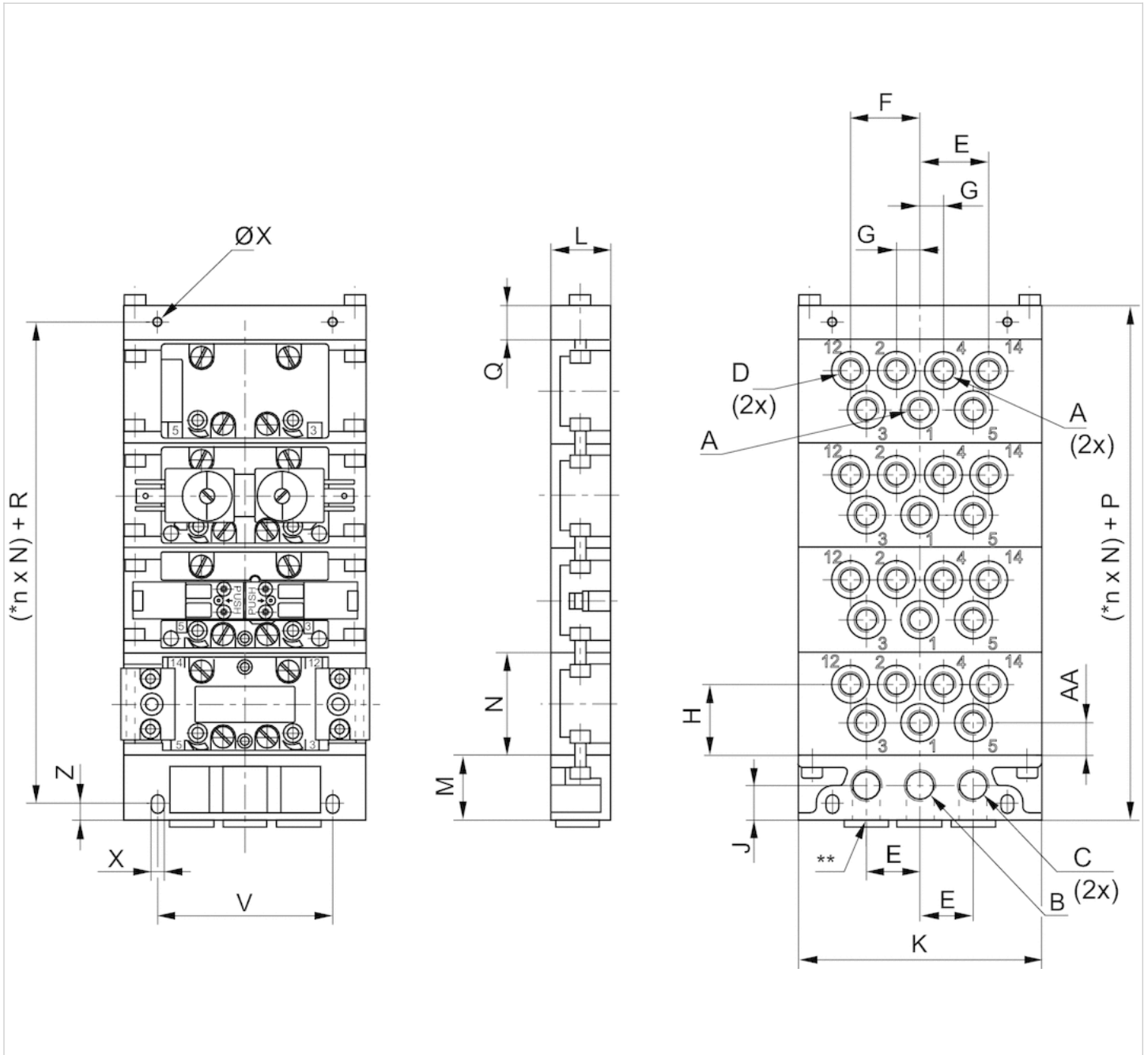

\*  $n$  = Number of subbases.

\*\* Alternative port openings, closed with plugs

## Dimensions

Part No.		A	B	C	D	E	F	G	H	J	K	L	M	N	P	Q	R	V
5801670000	ISO 1	G 1/8	G 1/4	G 1/4	G 1/8	22	28.5	9.5	29.5	14.5	100	25	27	43	41	14	27.5	72
5801680000	ISO 1	G 1/4	G 3/8	G 3/8	G 1/8	27	40	12.5	26.5	20	122	30	34	43	49	15	34	94

X	Z	AA
5.4	7	8

X	Z	AA
6.4	8	10

# End plate left, End plate right

- standard ISO 5599-1
- Frame size ISO 1
- type K
- Can be assembled into blocks

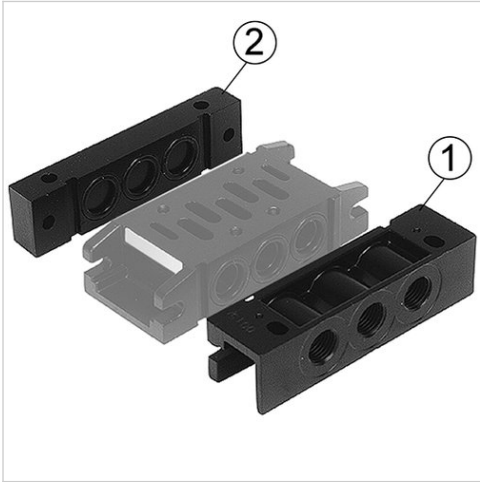

## Standards

Working pressure min./max.

Ambient temperature min./max.

Medium temperature min./max.

Medium

Exhaust (3,5)

Exhaust type

Weight

ISO 5599-1

-1 ... 16 bar

-20 ... 70 °C

-20 ... 70 °C

Compressed air

uncollected exhaust

Ports separated

See table below

An example configuration is illustrated.  
The delivered product may thus deviate from the illustration.

## Technical data

Part No.	Compressed air connection Input [1]	Compressed air connection Exhaust [3 / 5]	Weight
5801850000	G 1/4	G 1/4	0,15 kg
5801860000	-	-	0,08 kg

## Technical information

The min. control pressure must be adhered to, since otherwise faulty switching and valve failure may result!

The pressure dew point must be at least 15 °C under ambient and medium temperature and may not exceed 3 °C .

The oil content of compressed air must remain constant during the life cycle.

Use only the approved oils from AVENTICS. Further information can be found in the "Technical information" document (available in the MediaCentre).

## Technical information

Material	
Surface	painted
Base plate	Die-cast aluminum, black painted
Seal	Acrylonitrile butadiene rubber

## Dimensions

### Dimensions

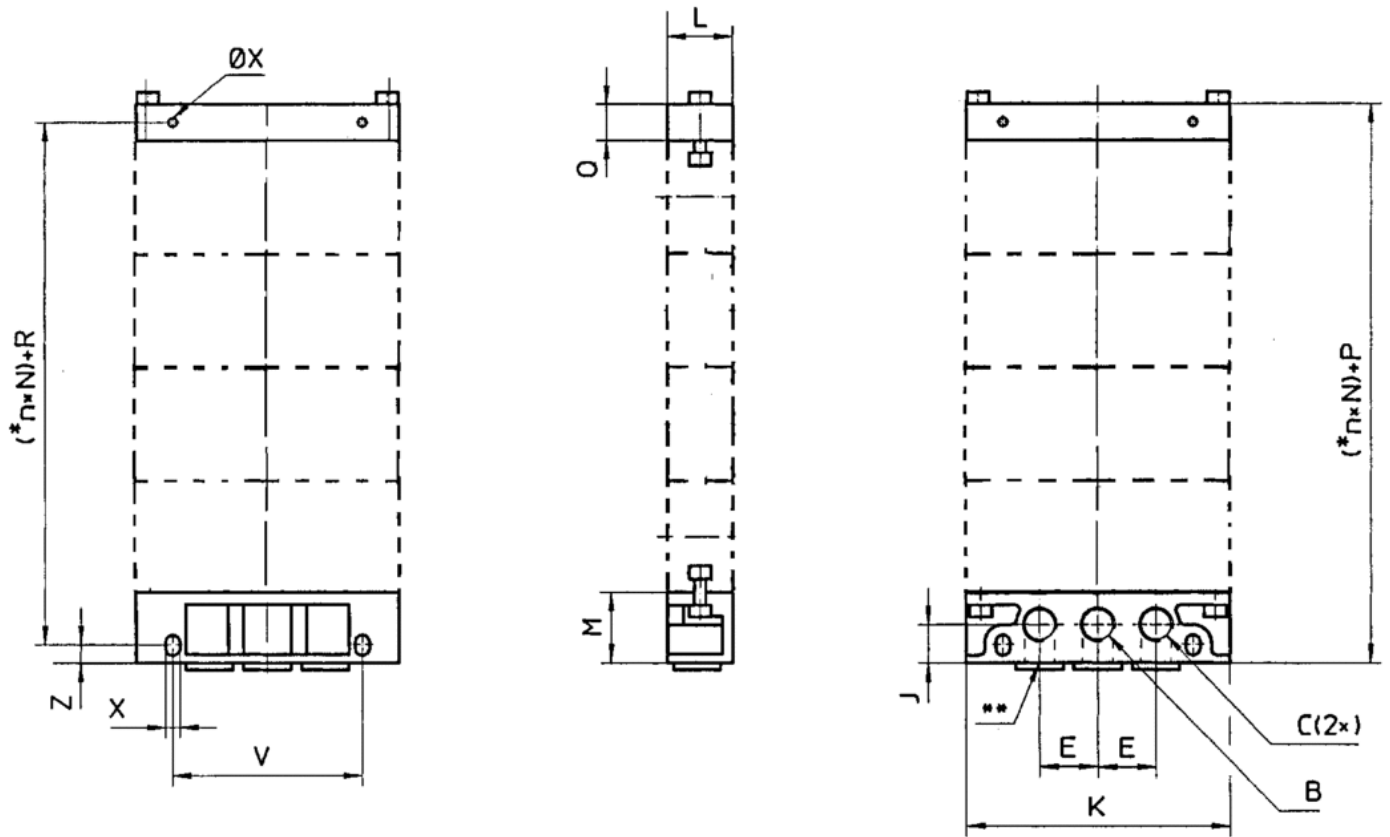

\* n = Number of subbases.

\*\* Alternative port openings, closed with plugs

## Dimensions

Part No.		B	C	E	J	K	L	M	P	Q	R	V	X	Z	Weight
5801850000	ISO 1	G 1/4	G 1/4	22	14.5	100	25	27	41	-	27.5	72	5.4	7	0,15 kg
5801860000	ISO 1	-	-	-	-	100	25	-	41	14	27.5	72	5.4	-	0,08 kg

# Single subbase, for soft-start valve

- Compressed air connection output G 1/2



Working pressure min./max.	-1 ... 16 bar
Ambient temperature min./max.	-20 ... 70 °C
Medium temperature min./max.	-20 ... 70 °C
Medium	Compressed air
Number of valve positions max.	1
Exhaust (3,5)	uncollected exhaust
Exhaust type	Ports separated
Weight	0,34 kg

## Technical data

Part No.	Compressed air connection Input [1]	Compressed air connection Output [2 / 4]
5834710000	G 1/2	G 1/2

Part No.	Compressed air connection Exhaust [3 / 5]	Compressed air connection Pilot connection [12]
5834710000	G 1/2	G 1/8

## Technical information

The min. control pressure must be adhered to, since otherwise faulty switching and valve failure may result!  
 The pressure dew point must be at least 15 °C under ambient and medium temperature and may not exceed 3 °C .  
 The oil content of compressed air must remain constant during the life cycle.  
 Use only the approved oils from AVENTICS. Further information can be found in the "Technical information" document (available in the MediaCentre).

## Technical information

Material	
Base plate	Die-cast aluminum, black painted

Dimensions

Dimensions

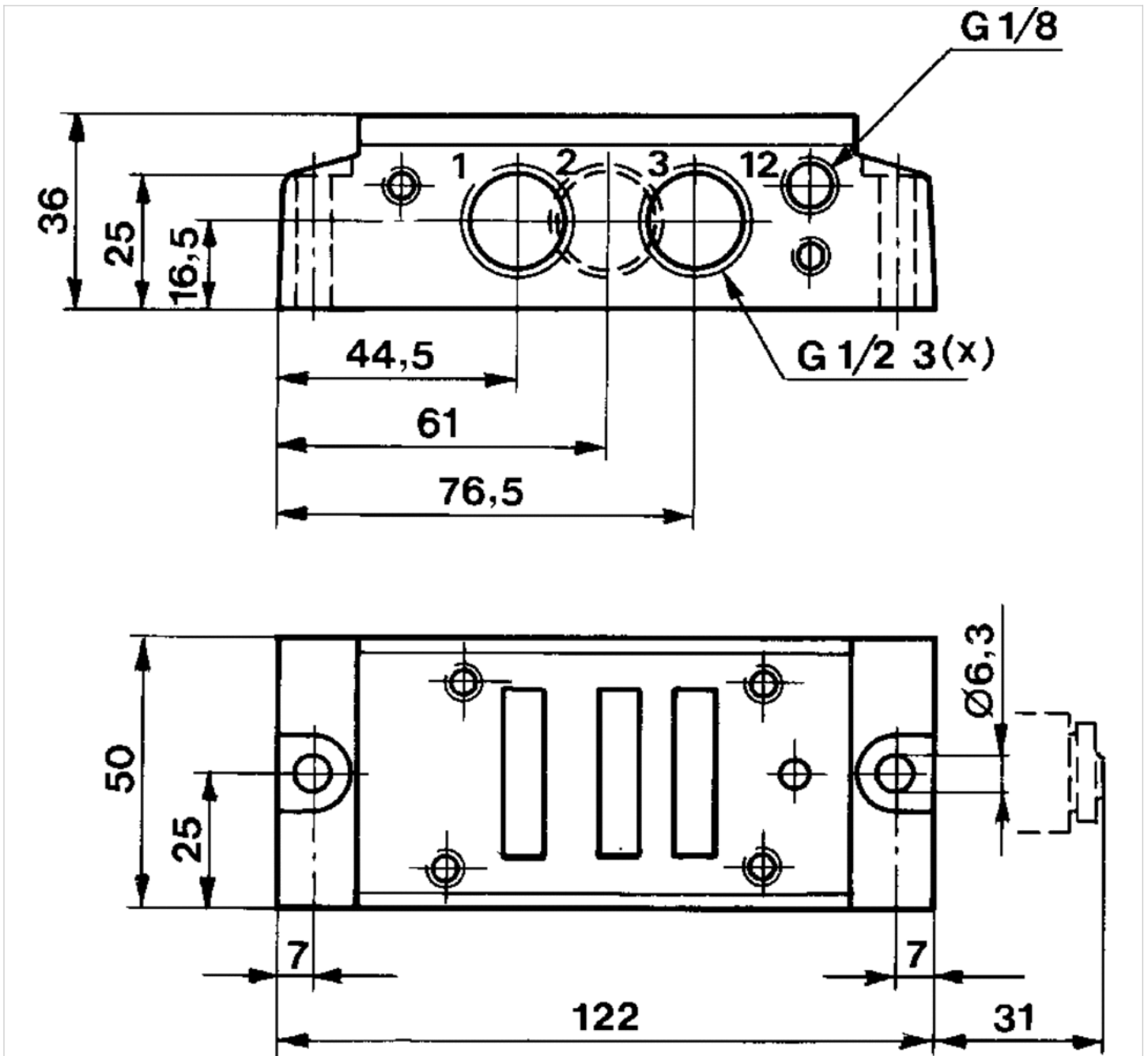



# Separator set

- standard ISO 5599-1, ISO 1 ISO 5599-1, ISO 1 ISO 2 ISO 5599-1, ISO 2 ISO 3 ISO 5599-1,  
ISO 3 ISO 4  
- type K



Standards

Ambient temperature min./max.

Weight

ISO 5599-1

-20 ... 70 °C

See table below

An example configuration is illustrated.  
The delivered product may thus deviate  
from the illustration.

## Technical data

Part No.	Type	Accessory type	Frame size	Delivery unit	Weight
5801880000	a	type K	ISO 1	3 piece	0,012 kg
5802880000	b	type K	ISO 1, ISO 2	3 piece	0,017 kg
5803880000	c	type K	ISO 2, ISO 3	3 piece	0,02 kg
5804880000	d	type K	ISO 3, ISO 4	3 piece	0,029 kg

## Technical information

Material	
Housing	Brass

## Dimensions

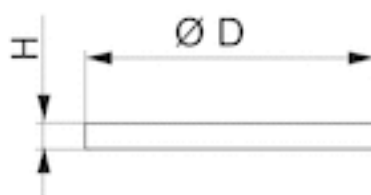

## Dimensions

Part No.	D	H
5801880000	13,2	2
5802880000	17,2	2
5803880000	20,5	2,2
5804880000	24,5	2,2

# Base plate, Ports 2 and 4 side or bottom

- standard ISO 5599-1
- Frame size ISO 1
- type G
- Compressed air connection output G 1/4
- Can be assembled into blocks



Standards	ISO 5599-1
Working pressure min./max.	-1 ... 16 bar
Ambient temperature min./max.	-20 ... 70 °C
Medium temperature min./max.	-20 ... 70 °C
Medium	Compressed air
Number of valve positions max.	1
Direction of pneumatic port (2,4)	Both directions possible
Direction of pneumatic port (14)	Down
Exhaust (3,5)	uncollected exhaust
Exhaust type	Ports separated
Weight	0,23 kg

An example configuration is illustrated.  
The delivered product may thus deviate from the illustration.

## Technical data

Part No.	Compressed air connection Input [1]	Compressed air connection Output [2 / 4]
5801500000	G 1/4	G 1/4

Part No.	Compressed air connection Pilot connection [12]
5801500000	G 1/8

Scope of delivery incl. seal and mounting screws

## Technical information

The min. control pressure must be adhered to, since otherwise faulty switching and valve failure may result!  
The pressure dew point must be at least 15 °C under ambient and medium temperature and may not exceed 3 °C .  
The oil content of compressed air must remain constant during the life cycle.  
Use only the approved oils from AVENTICS. Further information can be found in the "Technical information" document (available in the MediaCentre).

## Technical information

Material	
Base plate	Die-cast aluminum
Seal	Acrylonitrile butadiene rubber

## Dimensions

### Dimensions

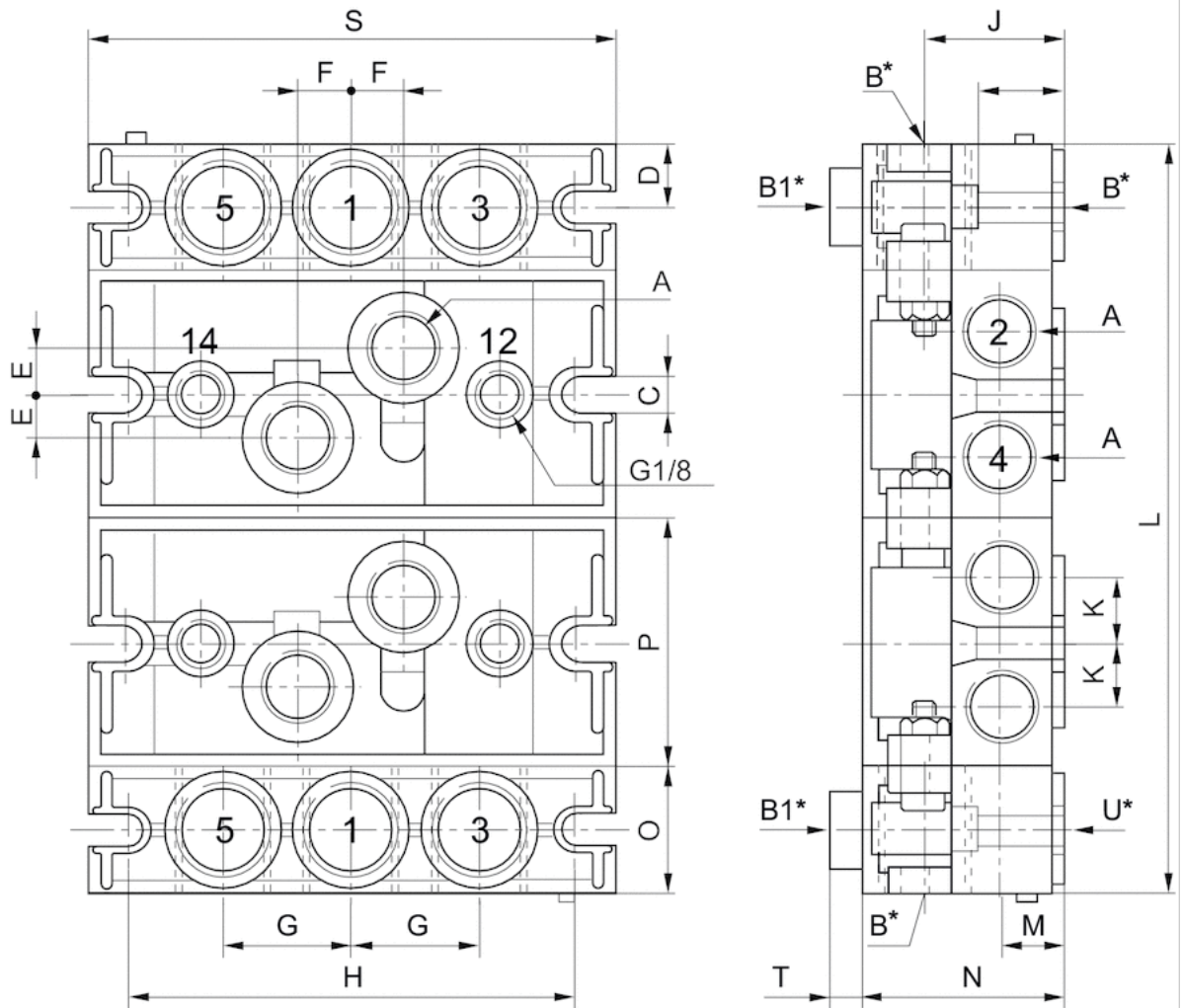

## Dimensions

Part No.		A	B	B1	C	D	E	F	G	H	J	K	L	M
5801500000	ISO 1	2 x G 1/4	3 x G 3/8	3 x G 1/4	5.5	11	5.5	9	22	92	24	12	n x 43 + 44	12
N	O	P	R	S	T									
36	22	45.7	17	106	8									

n = number of subbases

# End plate left, End plate right

- standard ISO 5599-1
- Frame size ISO 1
- type G
- Can be assembled into blocks
- Base plate principle, multiple
- Reversed pressure supply permissible



Standards	ISO 5599-1
Compressed air connection	according to ISO 5599-1
Working pressure min./max.	-1 ... 16 bar
Ambient temperature min./max.	-20 ... 70 °C
Medium temperature min./max.	-20 ... 70 °C
Medium	Compressed air
Direction of pneumatic port (1)	Both directions possible
Direction of pneumatic port (3,5)	Both directions possible
Exhaust (3,5)	uncollected exhaust
Exhaust type	Ports separated
Weight	0,26 kg

An example configuration is illustrated. The delivered product may thus deviate from the illustration.

## Technical data

Part No.	Compressed air connection	
	Input [1]	Exhaust [3 / 5]
5801510000	G 3/8	G 3/8

Delivered in pairs with all ports closed. Porting can be in end, top, or bottom (both ends). Porting is selected by drilling through dimensions B\*, B1\*, or U\* on drawing below., Scope of delivery incl. seal and mounting screws

## Technical information

The min. control pressure must be adhered to, since otherwise faulty switching and valve failure may result!  
 The pressure dew point must be at least 15 °C under ambient and medium temperature and may not exceed 3 °C .  
 The oil content of compressed air must remain constant during the life cycle.  
 Use only the approved oils from AVENTICS. Further information can be found in the "Technical information" document (available in the MediaCentre).

## Technical information

Material	
Base plate	Die-cast aluminum
Seal	Acrylonitrile butadiene rubber

## Dimensions

### Dimensions

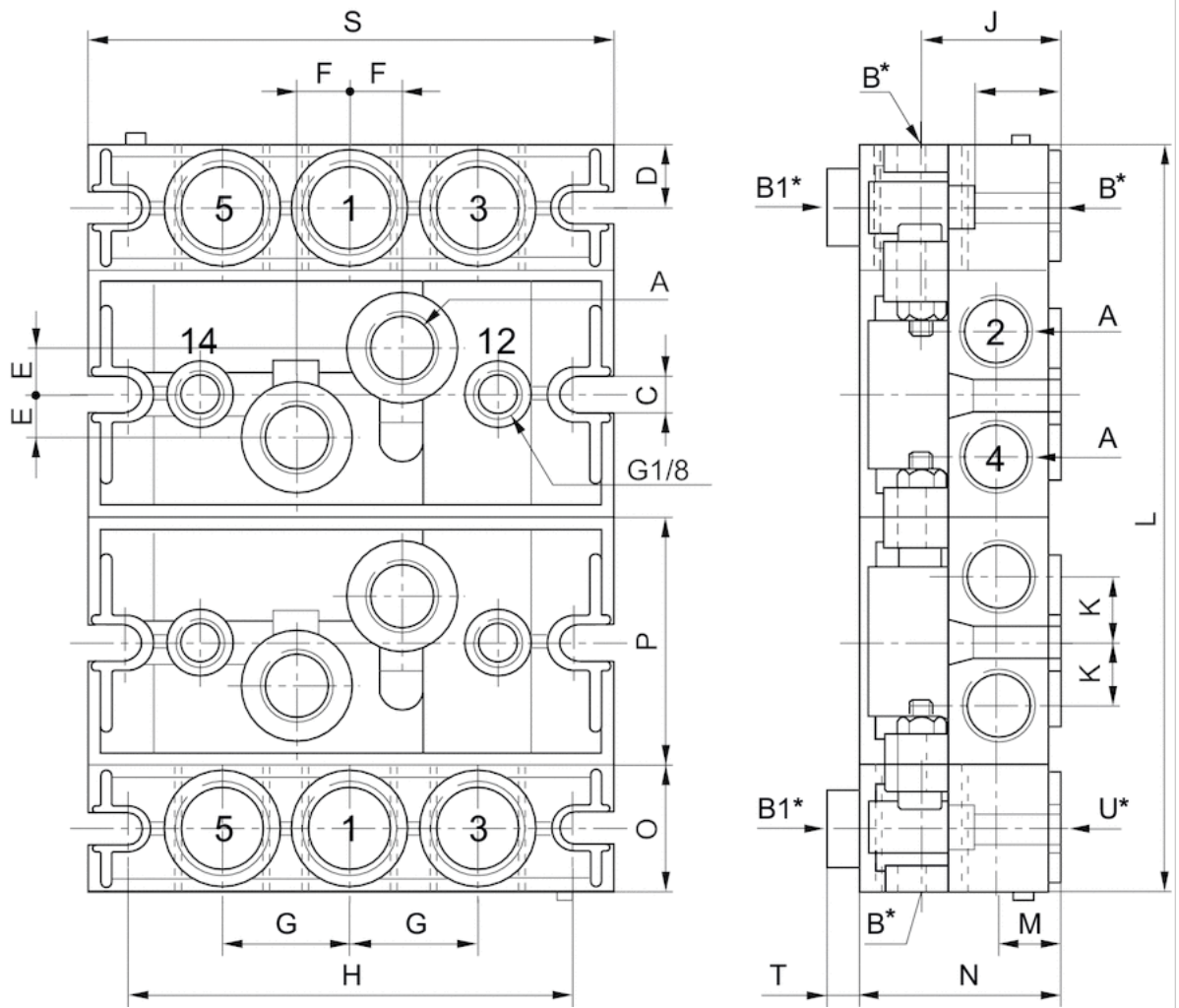

## Dimensions

Part No.	ISO 1	A	B*	B1*	C	D	E	F	G	H	J	K	L	M
5801510000	ISO 1	2 x G 1/4	3 x G 3/8	3 x G 1/4	5.5	11	5.5	9	22	92	24	12	n x 43 + 44	12

N	O	P	R	S	T	U*
36	22	45.7	17	106	8	3 x G 3/8

n = number of subbases

\*Dimensions B, B1, and U are prepared with threaded connections but must be drilled through as required for the desired porting configuration.

# Transition plate

- standard ISO 5599-1
- Frame size ISO 1, ISO 2
- type G
- Can be assembled into blocks
- Reversed pressure supply permissible



Standards	ISO 5599-1
Working pressure min./max.	-1 ... 16 bar
Ambient temperature min./max.	-20 ... 70 °C
Medium temperature min./max.	-20 ... 70 °C
Medium	Compressed air
Exhaust (3,5)	uncollected exhaust
Exhaust type	Ports separated
Weight	0,27 kg

## Technical data

Part No.

5802520000

Scope of delivery incl. seal and mounting screws

## Technical information

The min. control pressure must be adhered to, since otherwise faulty switching and valve failure may result!  
 The pressure dew point must be at least 15 °C under ambient and medium temperature and may not exceed 3 °C .  
 The oil content of compressed air must remain constant during the life cycle.  
 Use only the approved oils from AVENTICS. Further information can be found in the "Technical information" document (available in the MediaCentre).

The transition plate is used for combining subbases of different sizes in the same manifold.

## Technical information

Material	
Surface	painted
Base plate	Die-cast aluminum, black painted
Seal	Acrylonitrile butadiene rubber

Dimensions

Dimensions

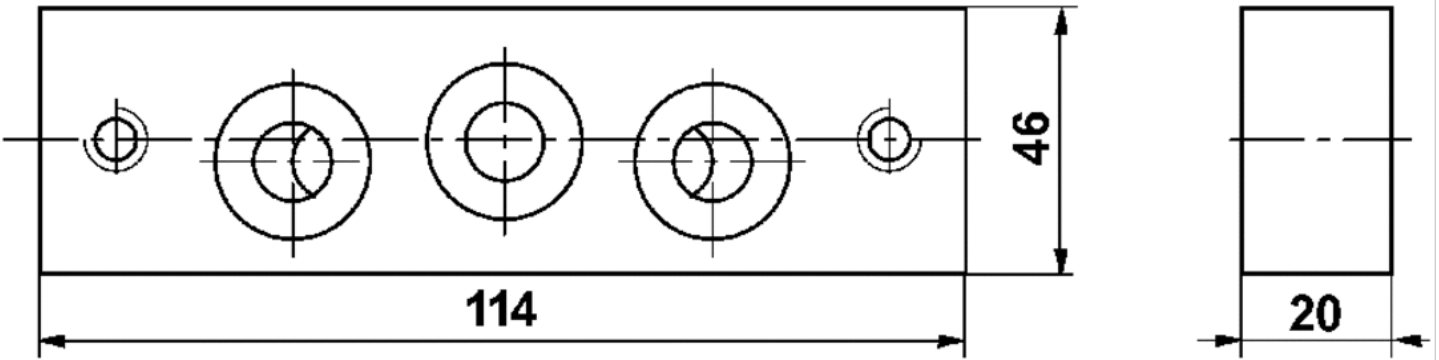



# Base plate, Ports 2 and 4 on side, 1,2 and 4 also on bottom

- standard ISO 5599-1
- Frame size ISO 1
- type H
- Compressed air connection output G 1/4
- Can be assembled into blocks



Standards	ISO 5599-1
Working pressure min./max.	0 ... 16 bar
Ambient temperature min./max.	-15 ... 70 °C
Medium temperature min./max.	-15 ... 80 °C
Medium	Compressed air
Grid dimension	43 mm
Exhaust type	Ports separated
Mounting screw	with hexagon socket
Weight	See table below

## Technical data

Part No.	Compressed air connection Input [1]	Compressed air connection Output [2 / 4]
1825503286	-	G 1/4
1825503288	-	G 1/4
1825503290	G 1/4	G 1/4
1825503292	G 1/4	G 1/4

Part No.	Compressed air connection Pilot connection [12]	Compressed air connection Pilot control exhaust [R]	Weight	Fig.
1825503286	M5	M5	0,24 kg	Fig. 1
1825503288	M5	M5	0,24 kg	Fig. 2
1825503290	M5	M5	0,27 kg	Fig. 3
1825503292	M5	M5	0,27 kg	Fig. 4

Part No.	
1825503286	1)
1825503288	2)
1825503290	3)
1825503292	4)

Scope of delivery incl. seal and mounting screws

- 1) Ports 2 and 4 on side, control pressure connection 12 and 14: single connection
- 2) Ports 2 and 4 on side, control pressure connection 12 and 14: central manifold
- 3) Ports 2 and 4 on side, 1,2 and 4 also on bottom, control pressure connection 12 and 14: single connection
- 4) Ports 2 and 4 on side, 1,2 and 4 also on bottom, control pressure connection 12 and 14: central manifold

## Technical information

The min. control pressure must be adhered to, since otherwise faulty switching and valve failure may result!

The pressure dew point must be at least 15 °C under ambient and medium temperature and may not exceed 3 °C .

The oil content of compressed air must remain constant during the life cycle.

Use only the approved oils from AVENTICS. Further information can be found in the “Technical information” document (available in the MediaCentre).

## Technical information

Material	
Housing	Die-cast aluminum
Base plate	Die-cast aluminum
Seal	Acrylonitrile butadiene rubber

# Dimensions

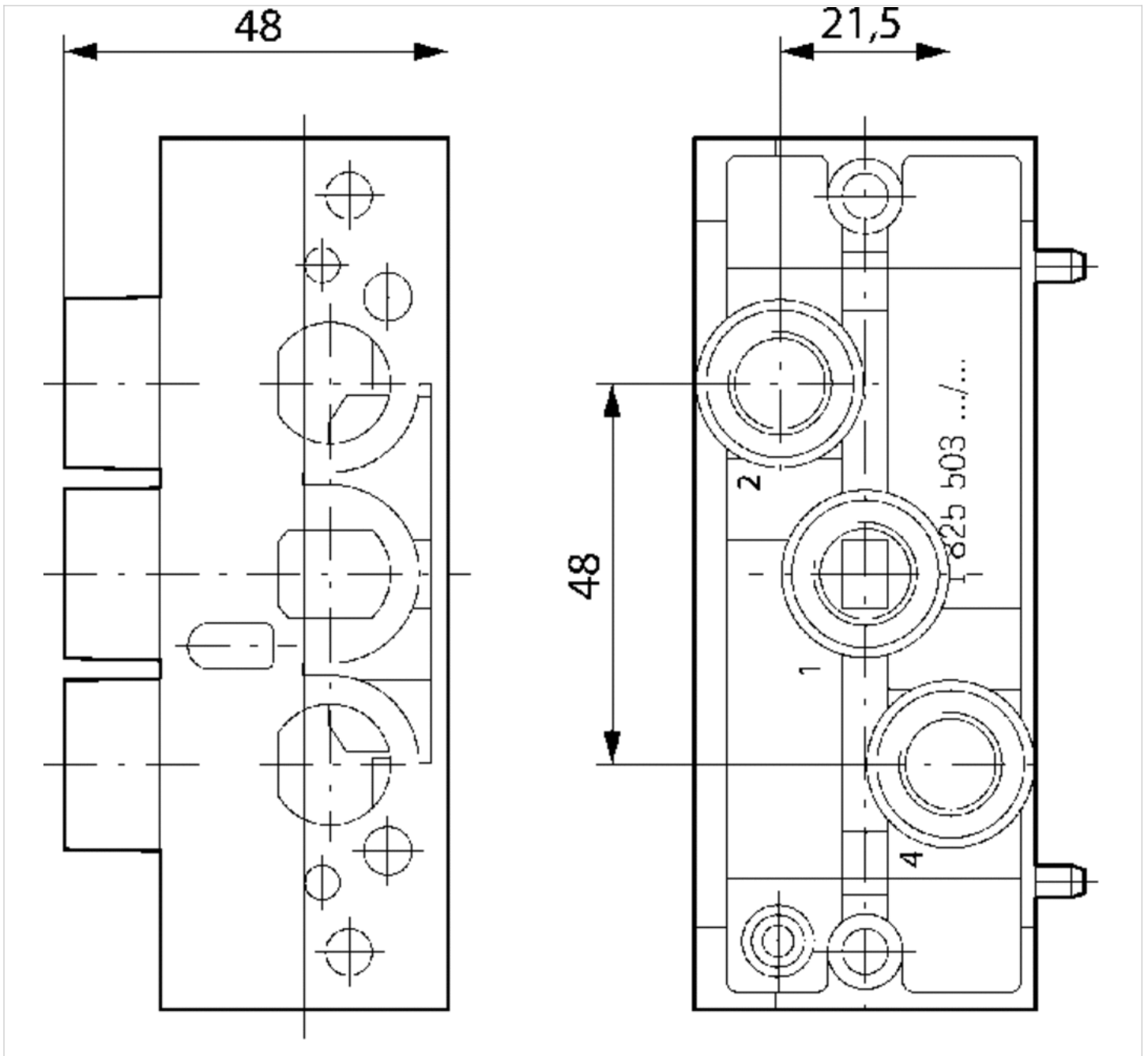
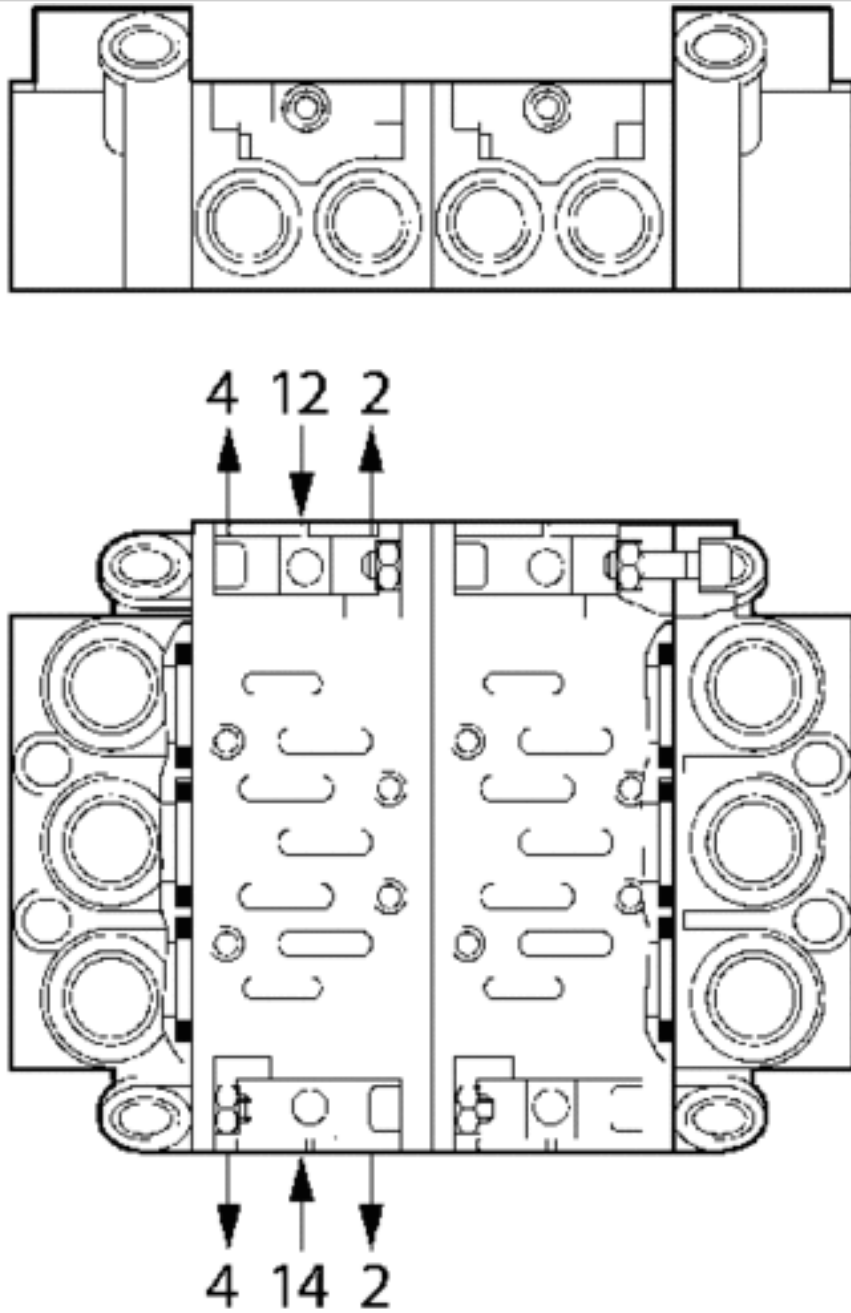

Fig. 1, ports 2 and 4 on side, Control pressure connection 12+14: single connection



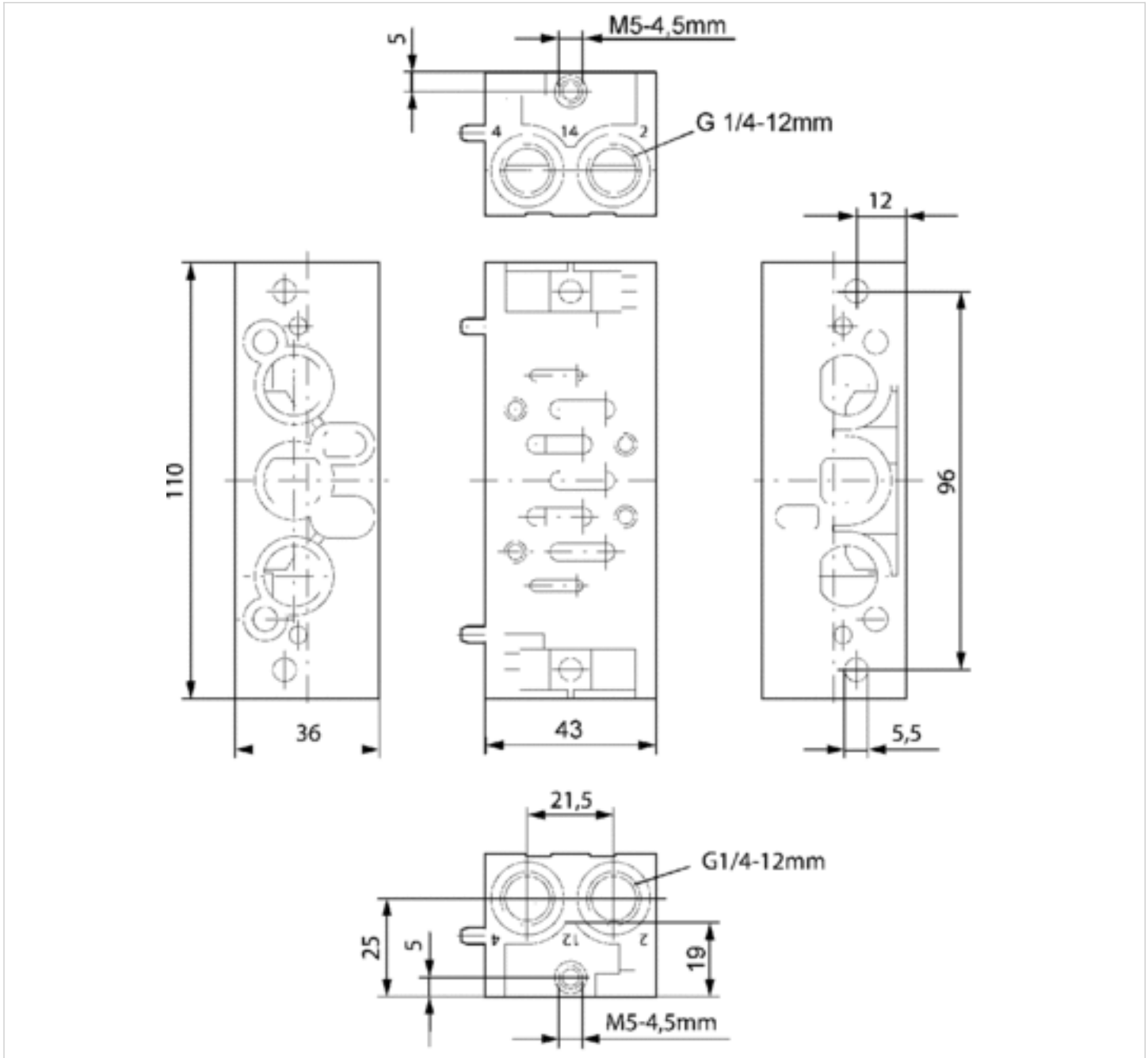
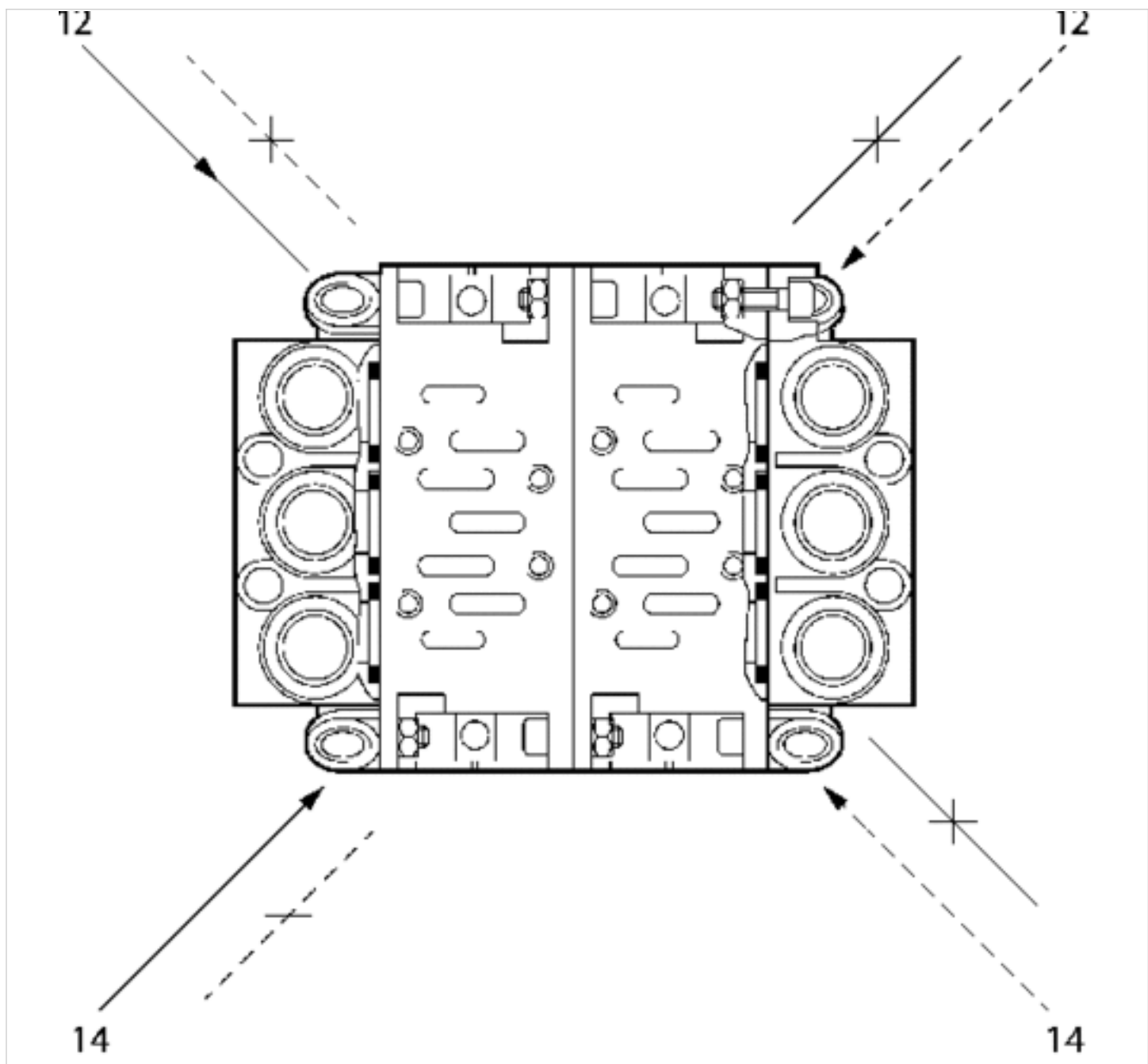

Fig. 2, ports 2 and 4 on side, Control pressure connection 12+14: central manifold



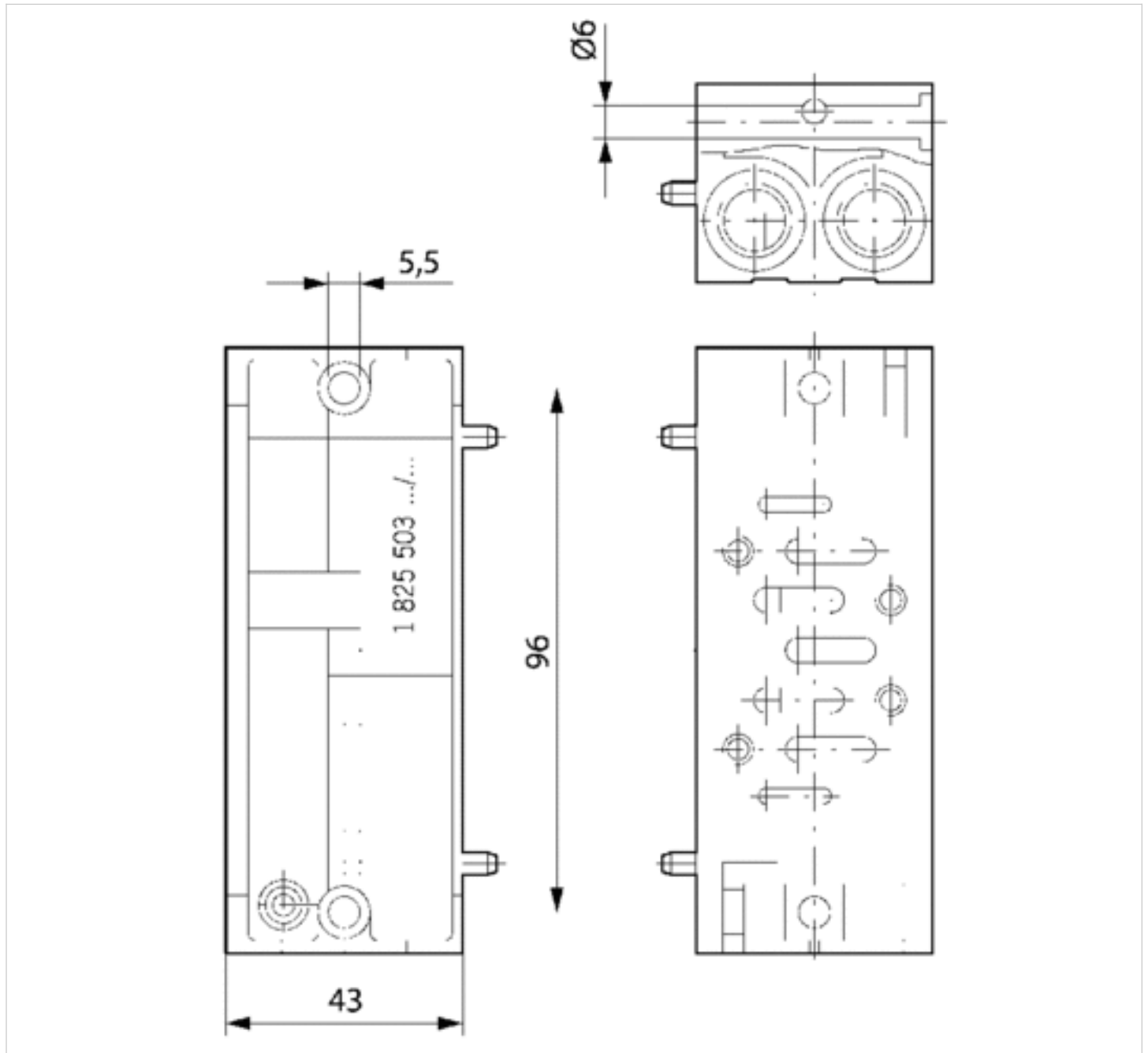

Fig. 3, Ports 2 and 4 on side, 1,2 and 4 also on bottom, Control pressure connection 12+14: single connection

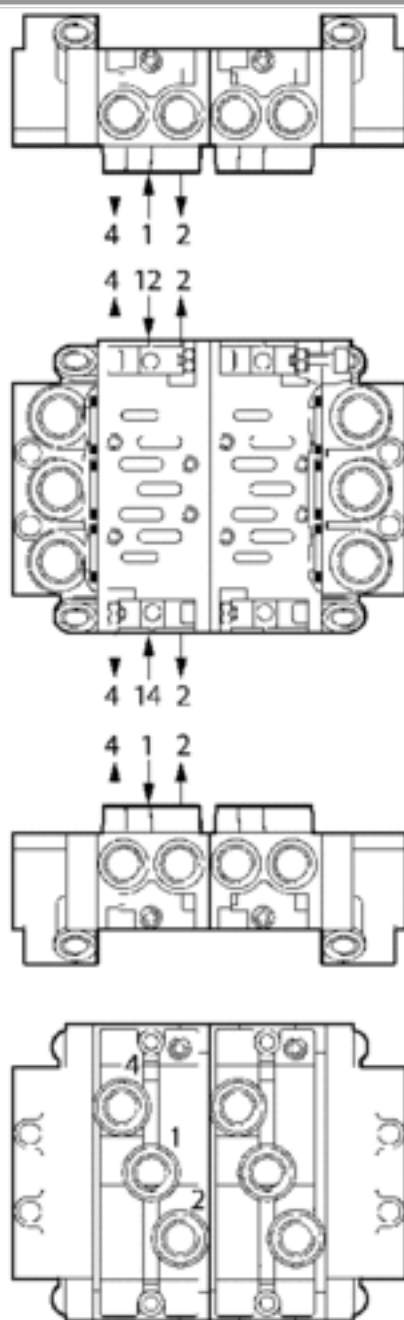
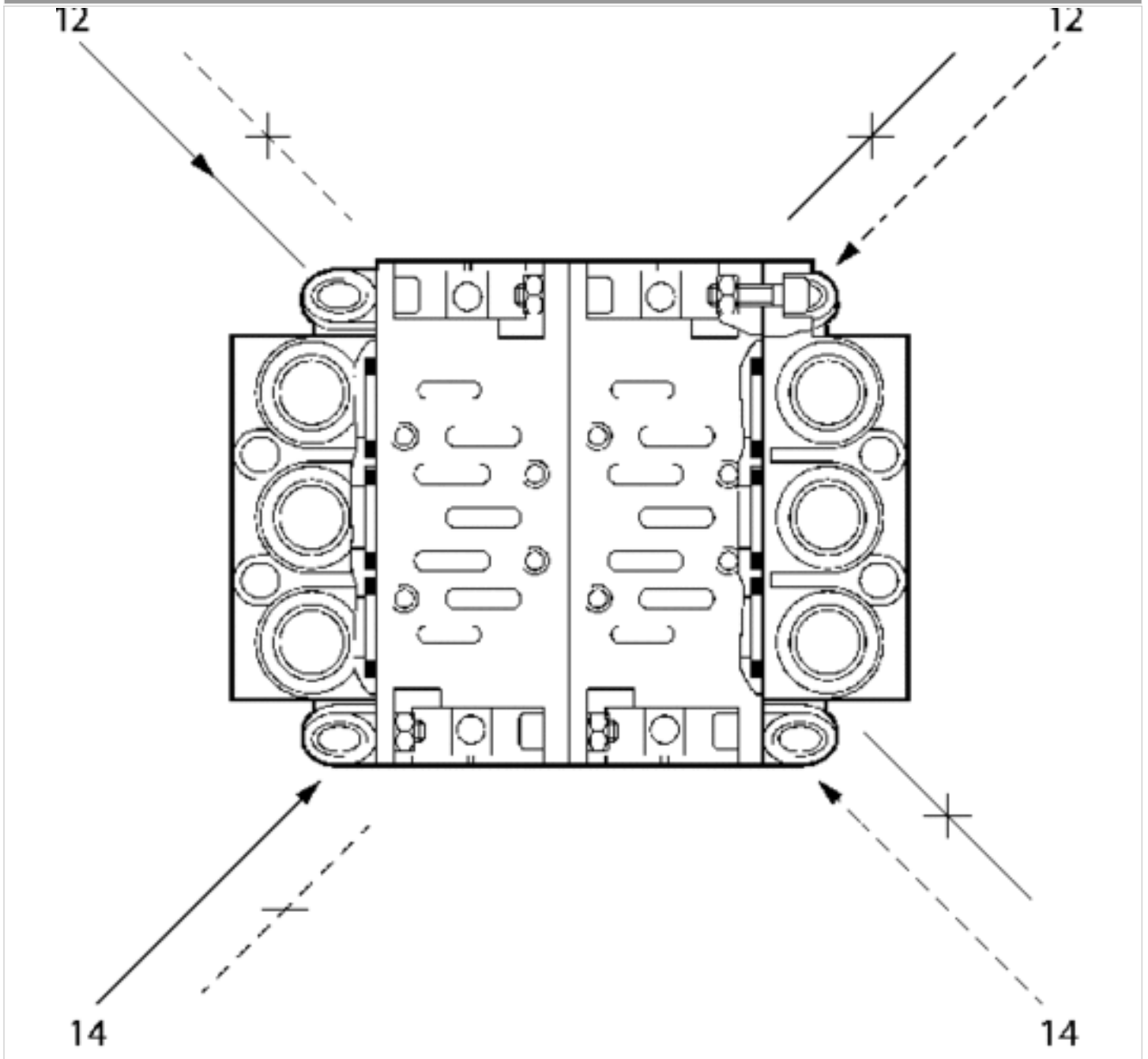



Fig. 4, Ports 2 and 4 on side, 1,2 and 4 also on bottom, Control pressure connection 12+14: central manifold



# End plate left, End plate right

- standard ISO 5599-1
- Frame size ISO 1
- type H
- Can be assembled into blocks



Standards	ISO 5599-1
Working pressure min./max.	0 ... 16 bar
Ambient temperature min./max.	-15 ... 70 °C
Medium temperature min./max.	-15 ... 70 °C
Medium	Compressed air
Exhaust (3,5)	With directional exhaust (3/5)
Exhaust type	Ports separated
Mounting screw	with hexagon socket
Weight	See table below

## Technical data

Part No.	Compressed air connection Input [1]	Compressed air connection Exhaust [3 / 5]
1825503294	G 3/8	G 3/8
1825503297	G 3/8	G 3/8

Part No.	Compressed air connection Pilot connection [12]	Compressed air connection Pilot control exhaust [R]	Weight	Fig.
1825503294	G 1/8	G 1/8	0,404 kg	Fig. 1
1825503297	G 1/8	G 1/8	0,382 kg	Fig. 2

Scope of delivery incl. seal and mounting screws

## Technical information

The min. control pressure must be adhered to, since otherwise faulty switching and valve failure may result!  
 The pressure dew point must be at least 15 °C under ambient and medium temperature and may not exceed 3 °C .  
 The oil content of compressed air must remain constant during the life cycle.  
 Use only the approved oils from AVENTICS. Further information can be found in the "Technical information" document (available in the MediaCentre).

## Technical information

Material	
Base plate	Die-cast aluminum
Seal	Acrylonitrile butadiene rubber

## Dimensions

### Dimensions

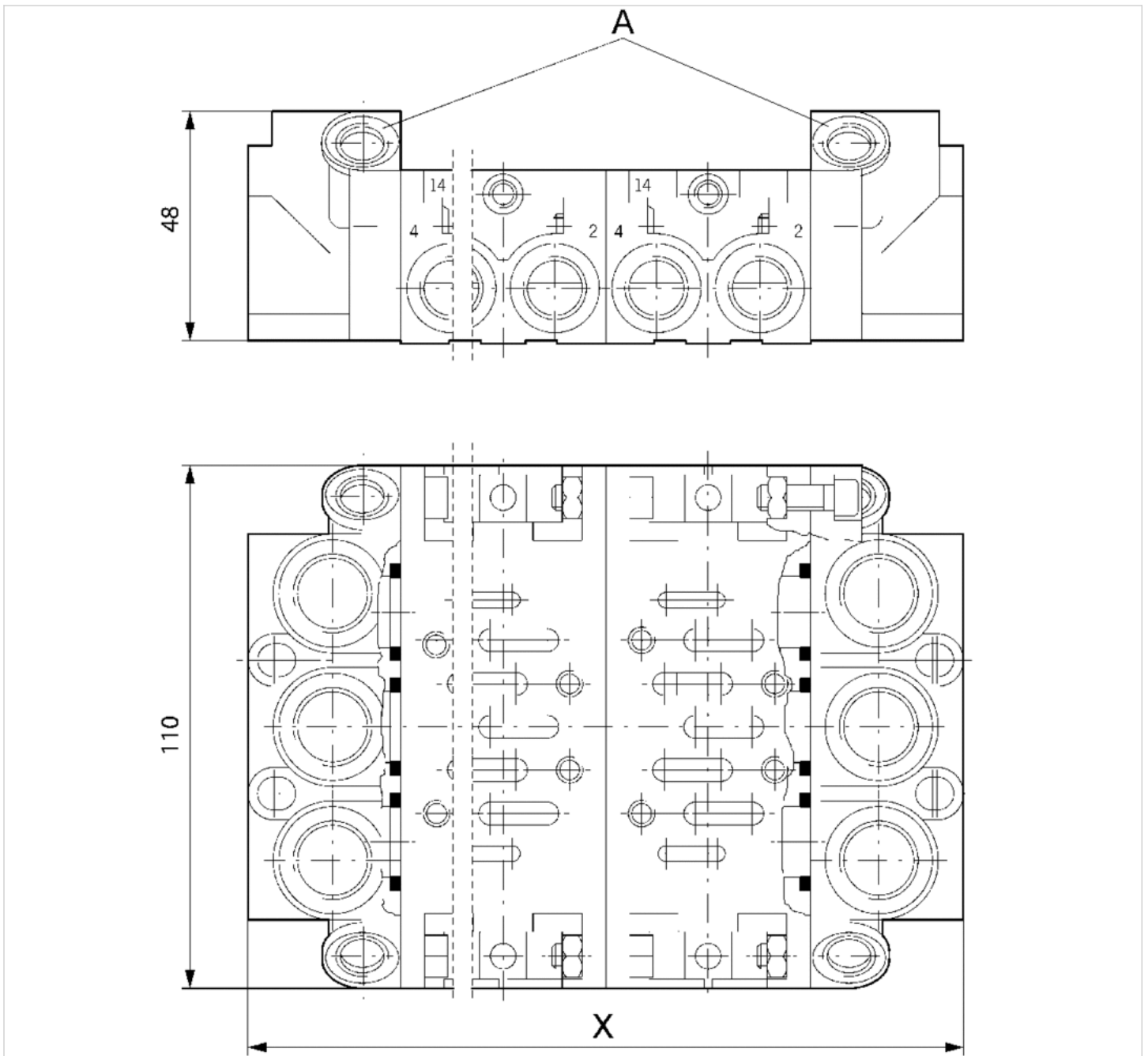

A = left and right end plates in two versions

## Dimensions

n	X
2	150
3	193
4	236
...	...
n	$n \cdot 43 + 64$

n = number of valve positions

## Dimensions

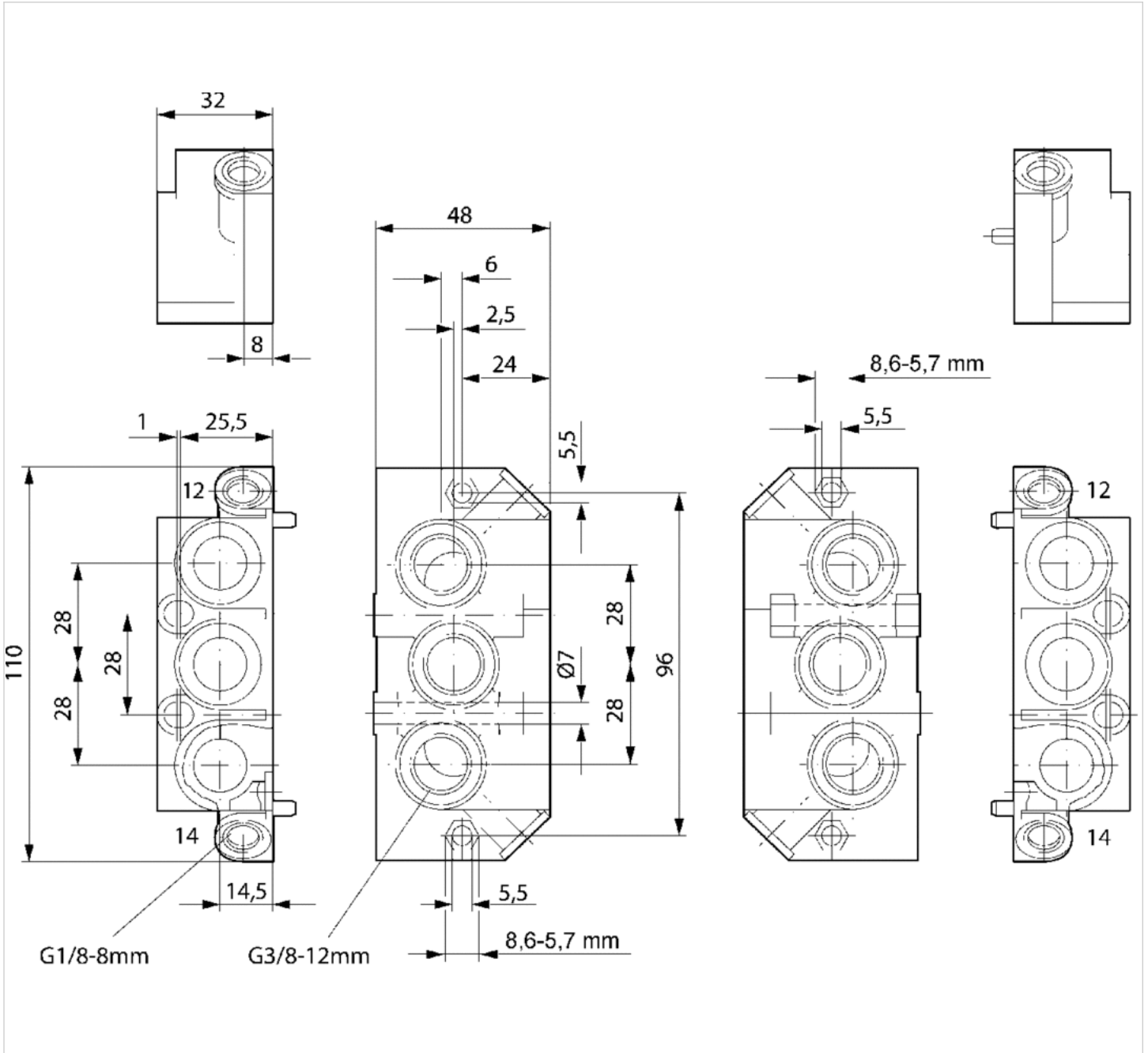

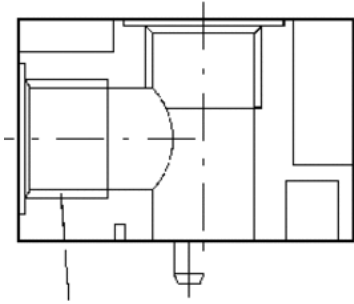

G3/8-12mm

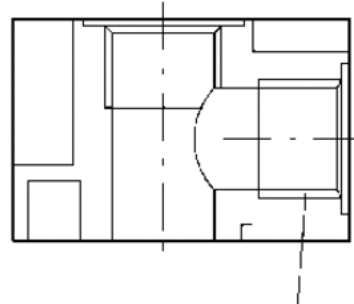

G3/8-12mm

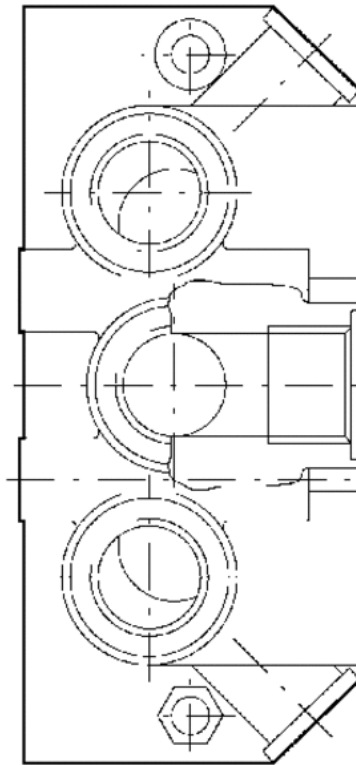
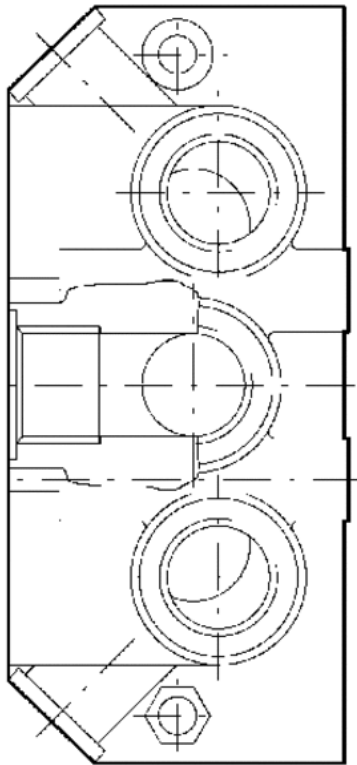

Fig. 1, Thread connections 1, 3, and 5 axial

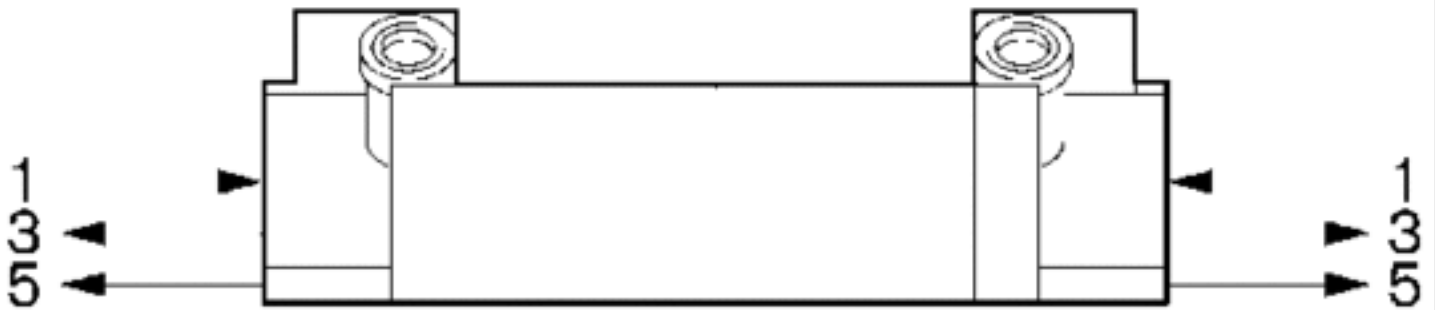
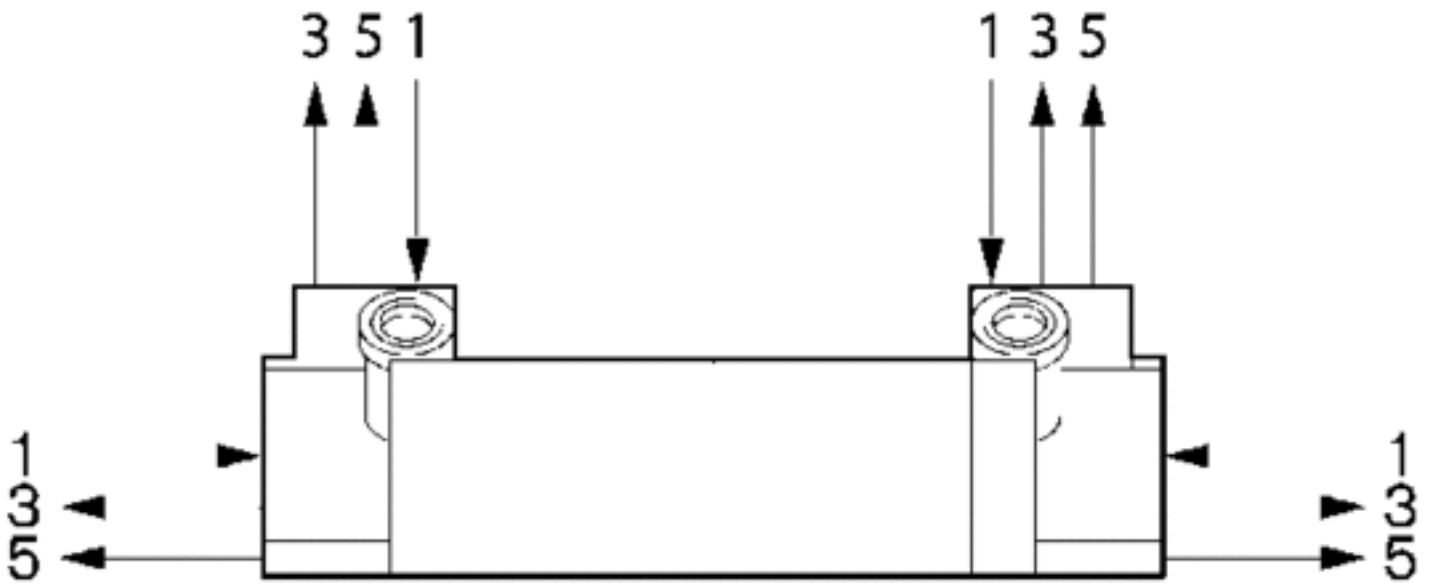

Fig. 2, Thread connections 1, 3, and 5 axial and from the top



# Supply plate

- standard ISO 5599-1
- Frame size ISO 1
- type H
- Can be assembled into blocks
- Plate principle



Standards	ISO 5599-1
Working pressure min./max.	1 ... 10 bar
Medium	Compressed air
Grid dimension	30 mm
Direction of pneumatic port (1)	Up
Direction of pneumatic port (3,5)	Up
Exhaust (3,5)	With directional exhaust (3/5)
Mounting screw	with hexagon socket
Weight	0,22 kg

## Technical data

Part No.	Compressed air connection	
	Input [1]	Exhaust [3 / 5]
1825503314	G 3/8	G 3/8

Scope of delivery incl. seal and mounting screws

## Technical information

The min. control pressure must be adhered to, since otherwise faulty switching and valve failure may result!  
 The pressure dew point must be at least 15 °C under ambient and medium temperature and may not exceed 3 °C .  
 The oil content of compressed air must remain constant during the life cycle.  
 Use only the approved oils from AVENTICS. Further information can be found in the "Technical information" document (available in the MediaCentre).

## Technical information

Material	
Housing	Aluminum
Base plate	Aluminum
Seal	Acrylonitrile butadiene rubber



# Dimensions

## Dimensions

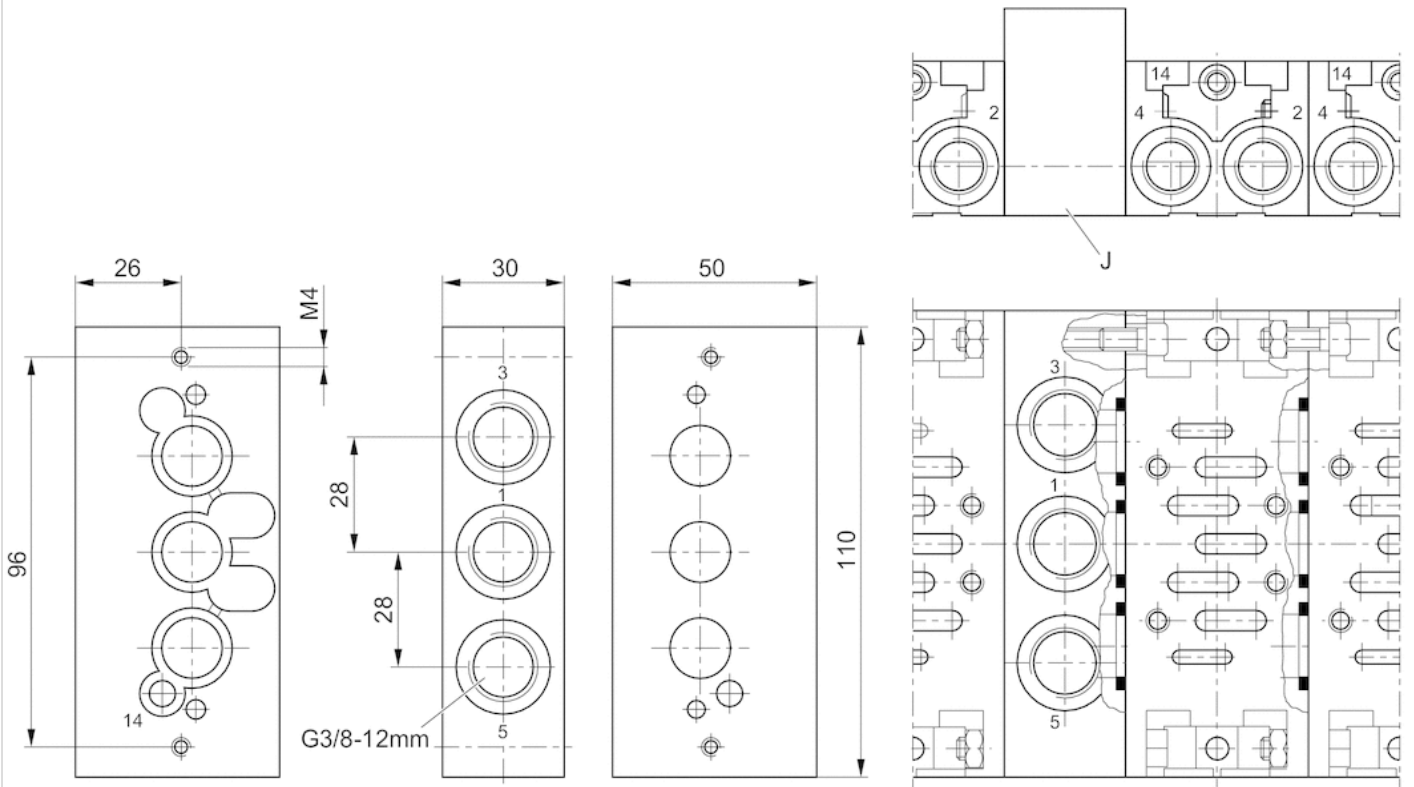

# Seal for supply plate

- standard ISO 5599-1

- type H



Standards

ISO 5599-1

Ambient temperature min./max.

-20 ... 70 °C

Weight

See table below

## Technical data

Part No.	Fig.	Type	Accessory type
1821015047	Fig. 1	Molded seal, separate channel 1, connect channels 5 and 3	type H
1821015043	Fig. 2	Molded seal, separate channels 1, 3 and 5	type H

Part No.	Delivery unit	Weight
1821015047	1 piece	0,004 kg
1821015043	1 piece	0,01 kg

## Technical information

Material	
Seal	Acrylonitrile butadiene rubber

Dimensions

Fig. 2

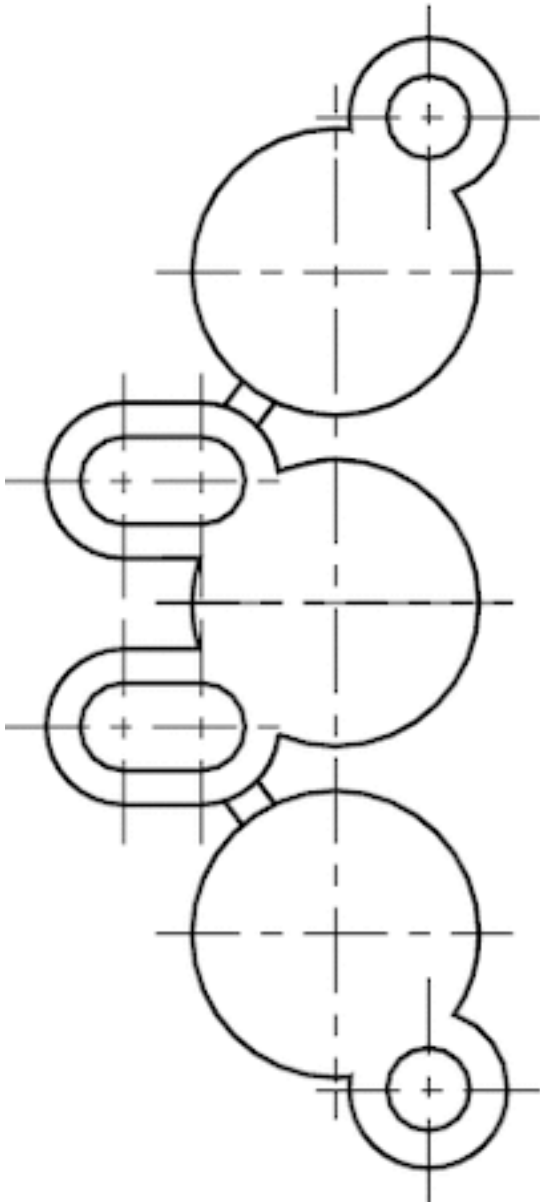
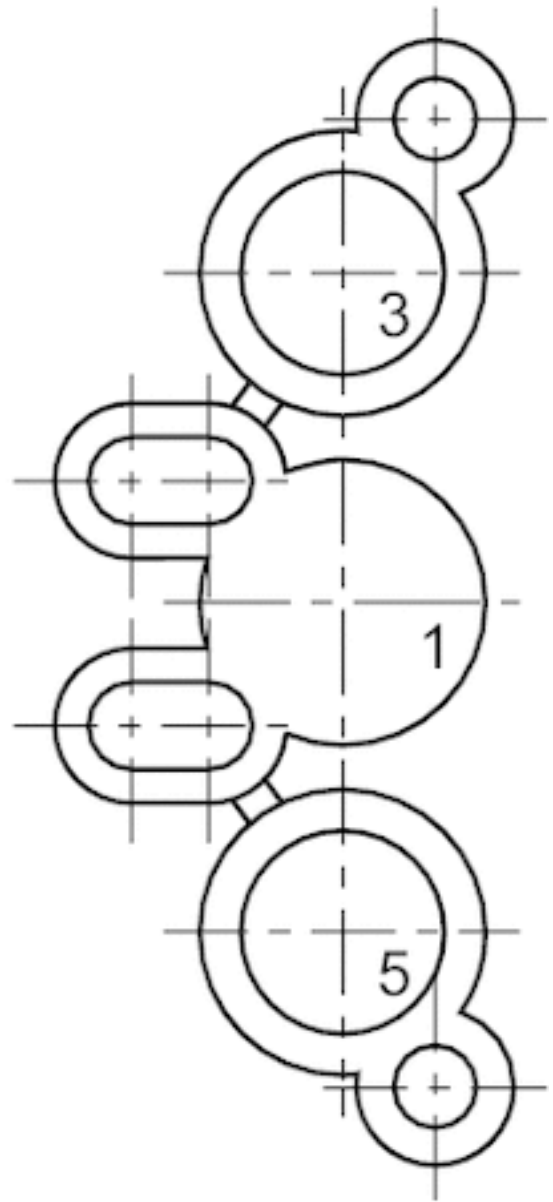

Fig. 1



# Blanking plate

- standard ISO 5599-1
- Frame size ISO 1 ISO 2 ISO 3 ISO 4



Standards	ISO 5599-1
Working pressure min./max.	-1 ... 16 bar
Ambient temperature min./max.	-20 ... 70 °C
Medium temperature min./max.	-20 ... 70 °C
Medium	Compressed air
Number of valve positions max.	1
Weight	See table below

## Technical data

Part No.	Frame size	Weight
5801870000	ISO 1	0,055 kg
5802870000	ISO 2	0,1 kg
5803870000	ISO 3	0,21 kg
5804870000	ISO 4	0,27 kg

Scope of delivery incl. seal and mounting screws

## Technical information

The min. control pressure must be adhered to, since otherwise faulty switching and valve failure may result!  
 The pressure dew point must be at least 15 °C under ambient and medium temperature and may not exceed 3 °C .  
 The oil content of compressed air must remain constant during the life cycle.  
 Use only the approved oils from AVENTICS. Further information can be found in the "Technical information" document (available in the MediaCentre).

## Technical information

Material	
Housing	Die-cast aluminum, black painted
Base plate	Die-cast aluminum
Seal	Acrylonitrile butadiene rubber

Dimensions

Dimensions

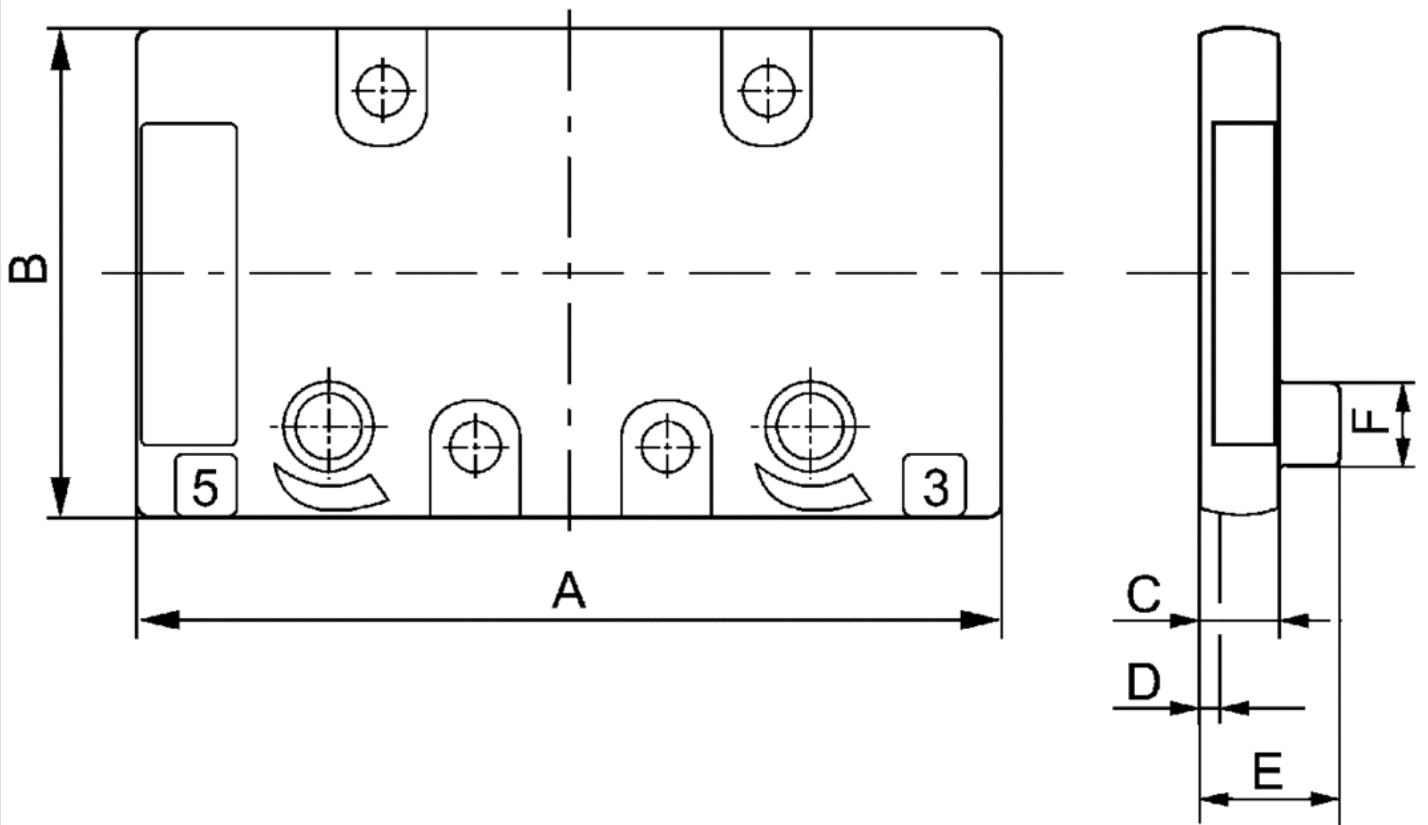

Dimensions

Part No.	A	B	C	D	E	F	Weight
5801870000	69	39	7	2	–	–	0,055 kg
5802870000	86.4	49.4	9	2	–	–	0,1 kg
5803870000	116.5	63.5	10	2	15	12	0,21 kg
5804870000	142.5	74.5	10	2	20	15	0,27 kg

# throttle insert for flow control, Port 3/5

- for 581  
- size 1



Weight

0,014 kg

## Technical data

Part No.

5811001000

delivered in pairs incl. plug set

## Dimensions

### Dimensions

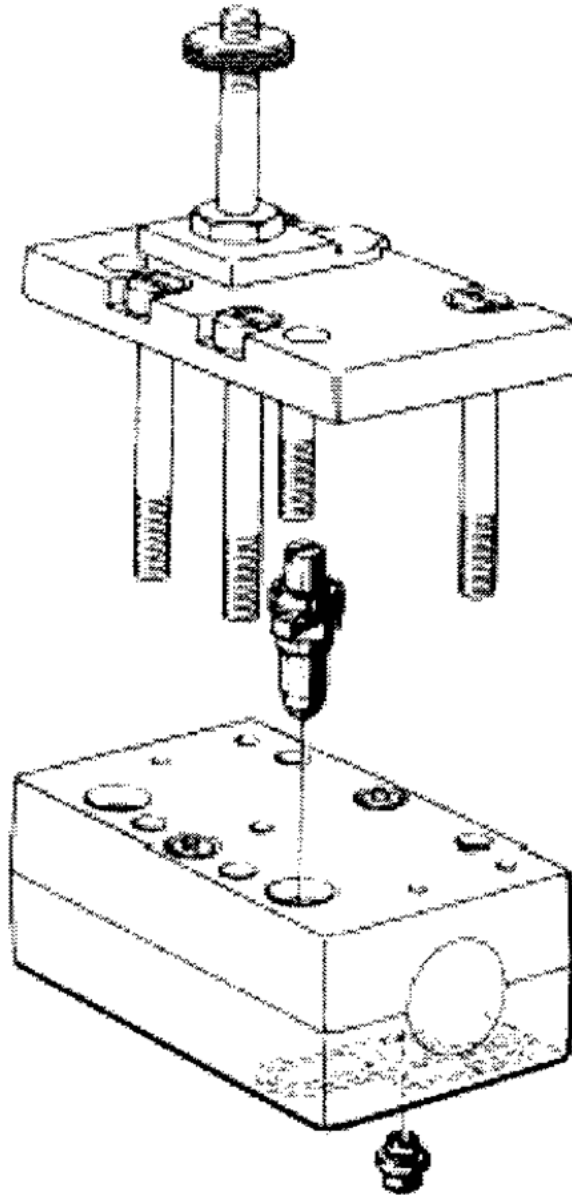

# plug set for flow control screws

- for 581

- size 1



Weight

0,015 kg

## Technical data

Part No.
5811000000

Delivered in pairs, for modification of a valve from "with throttle set" to "without throttle set"

## Technical information

Material	
Housing	Polyamide



# Maintenance plate to exchange valve

- for 581
- size 1
- standard ISO 5599-1



standard	ISO 5599-1
Ambient temperature min./max.	-10 ... 50 °C
Medium	Compressed air
Max. particle size	50 µm
Oil content of compressed air	40 ... 400 mg/m³
Weight	0,2 kg

## Technical data

Part No.
5801590000

## Technical information

Material	
Housing	Aluminum, black anodized

Dimensions

Dimensions

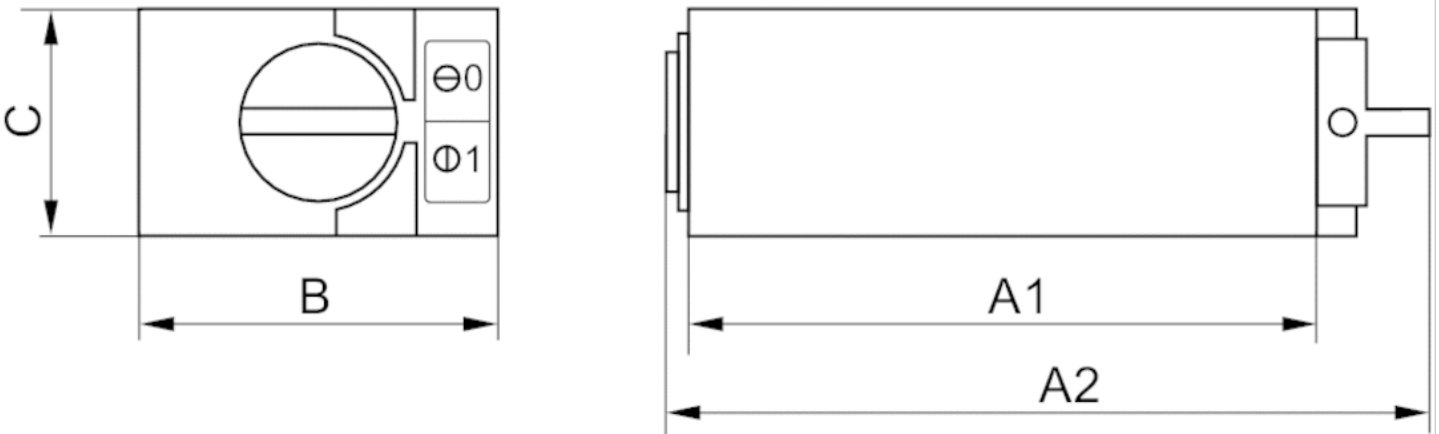

Dimensions

Part No.	A1	A2	B	C
5801590000	70	85	40	25

# Pressure regulator for vertical stacking

- standard ISO 5599-1

- Frame size ISO 1







- Controlled port 1 2 4 2, 4



Working pressure min./max.	16 bar
Adjustment range min./max.	0,5 ... 12 bar
Ambient temperature min./max.	5 ... 50 °C
Medium	Compressed air
Max. particle size	5 µm
Oil content of compressed air	0 ... 5 mg/m <sup>3</sup>
Weight	See table below

The delivered product may vary from that in the illustration.

## Technical data

Part No.		Frame size	Controlled port	Weight	Fig.	
0821302048		ISO 1	1	1,15 kg	Fig. 1	1)
0821302060		ISO 1	1	1,19 kg	Fig. 1	2)
0821302054		ISO 1	2	1,15 kg	Fig. 1	1)
0821302062		ISO 1	2	1,19 kg	Fig. 1	2)
0821302057		ISO 1	4	1,15 kg	Fig. 1	1)
0821302063		ISO 1	4	1,19 kg	Fig. 1	2)
0821302051		ISO 1	2, 4	1,57 kg	Fig. 2	1)
0821302061		ISO 1	2, 4	1,61 kg	Fig. 2	2)

Scope of delivery incl. seal and mounting screws, pressure regulator without gauge adapter, cannot be combined with IS12 ISO valves

1) with pressure gauge

2) with pressure gauge and adapter

## Technical information

Material	
Housing	Zinc
Seals	Butadiene rubber

## Dimensions

Fig. 1

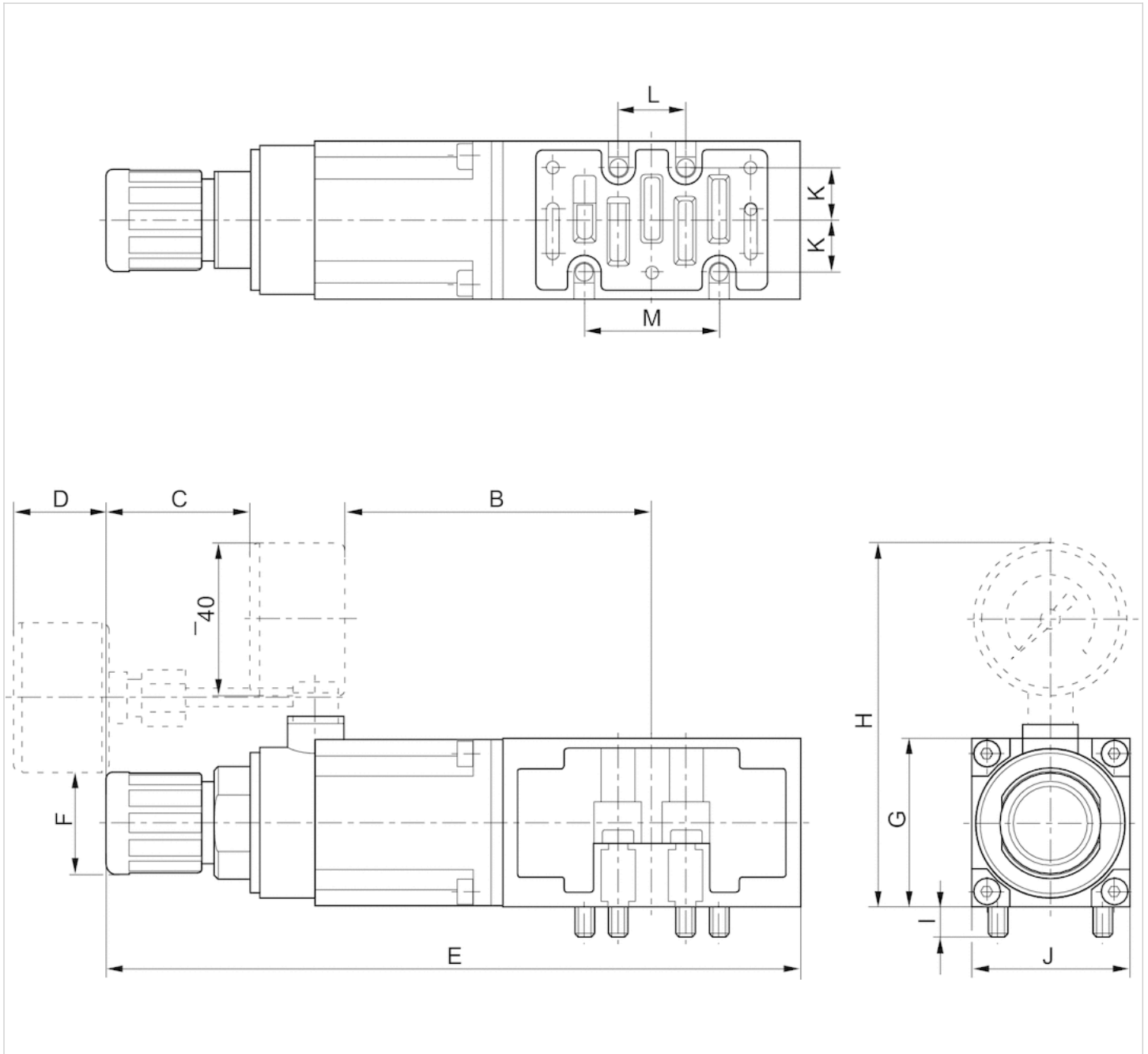

## Dimensions

Part No.	B±5	C±5	D±5	E±7	Ø F	G±5	H±5	I±2.5	J±5	K±2.5	L±2.5	M±5
0821302048	82	38,6	—	186	27	45	97,5	8	42.5	14	18	36
0821302060	—	—	25	186	27	45	97,5	8	42.5	14	18	36
0821302054	82	38,5	—	199	27	45	97,5	8	42.5	14	18	36
0821302062	—	—	25	199	27	45	97,5	8	42.5	14	18	36

## Dimensions

Fig. 2

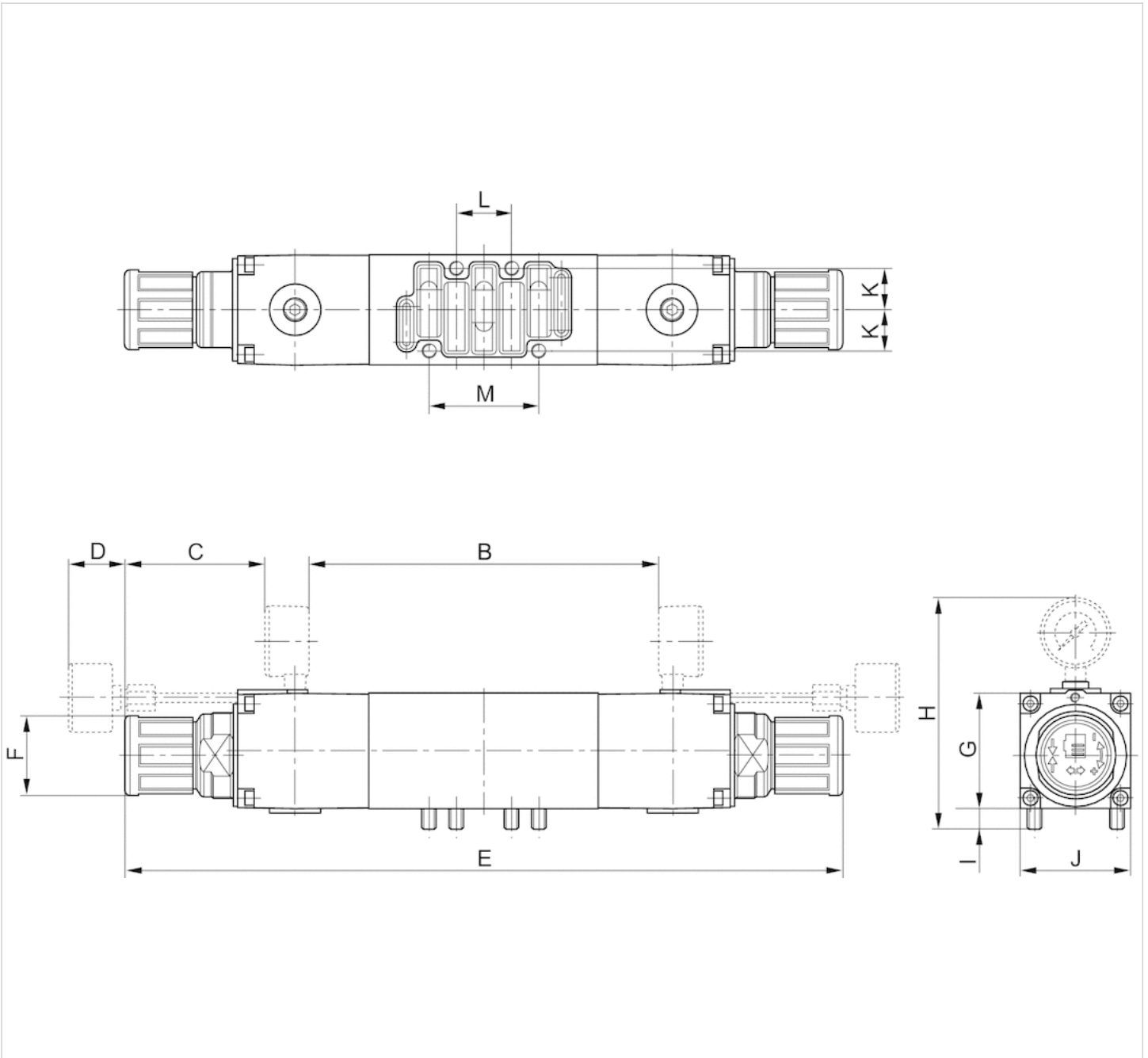

## Dimensions

Part No.	B±5	C±5	D±5	E±7	Ø F	G±5	H±5	I±2.5	J±5	K±2.5	L±2.5	M±5
0821302051	164	38,6	—	292	27	45	96,5	8	42.5	14	18	36
0821302061	—	—	25	292	27	45	—	8	42.5	14	18	36

Diagrams

Flow rate characteristic

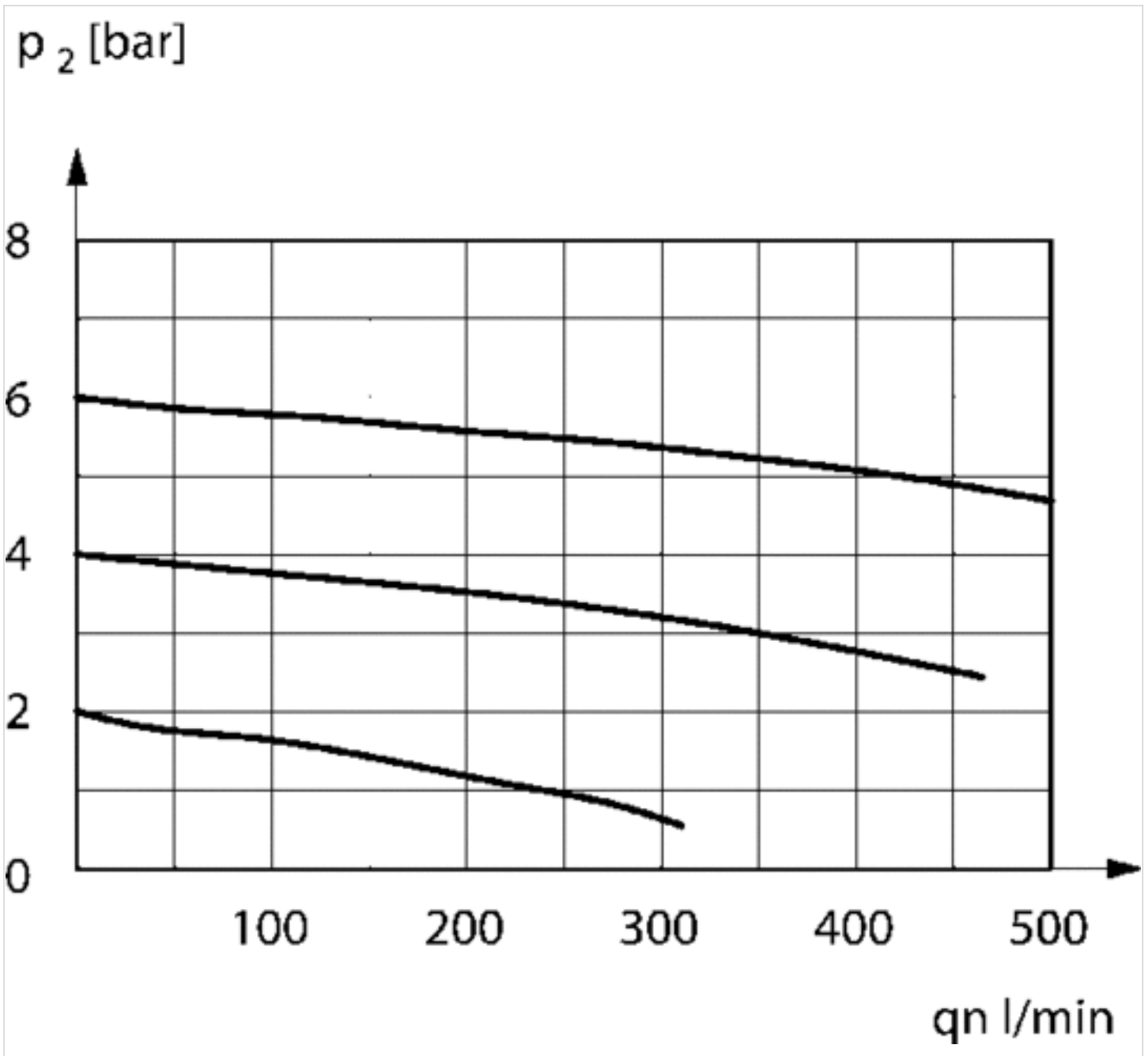

controlled connection 1  
Controlled connection 2  
Controlled connection 4

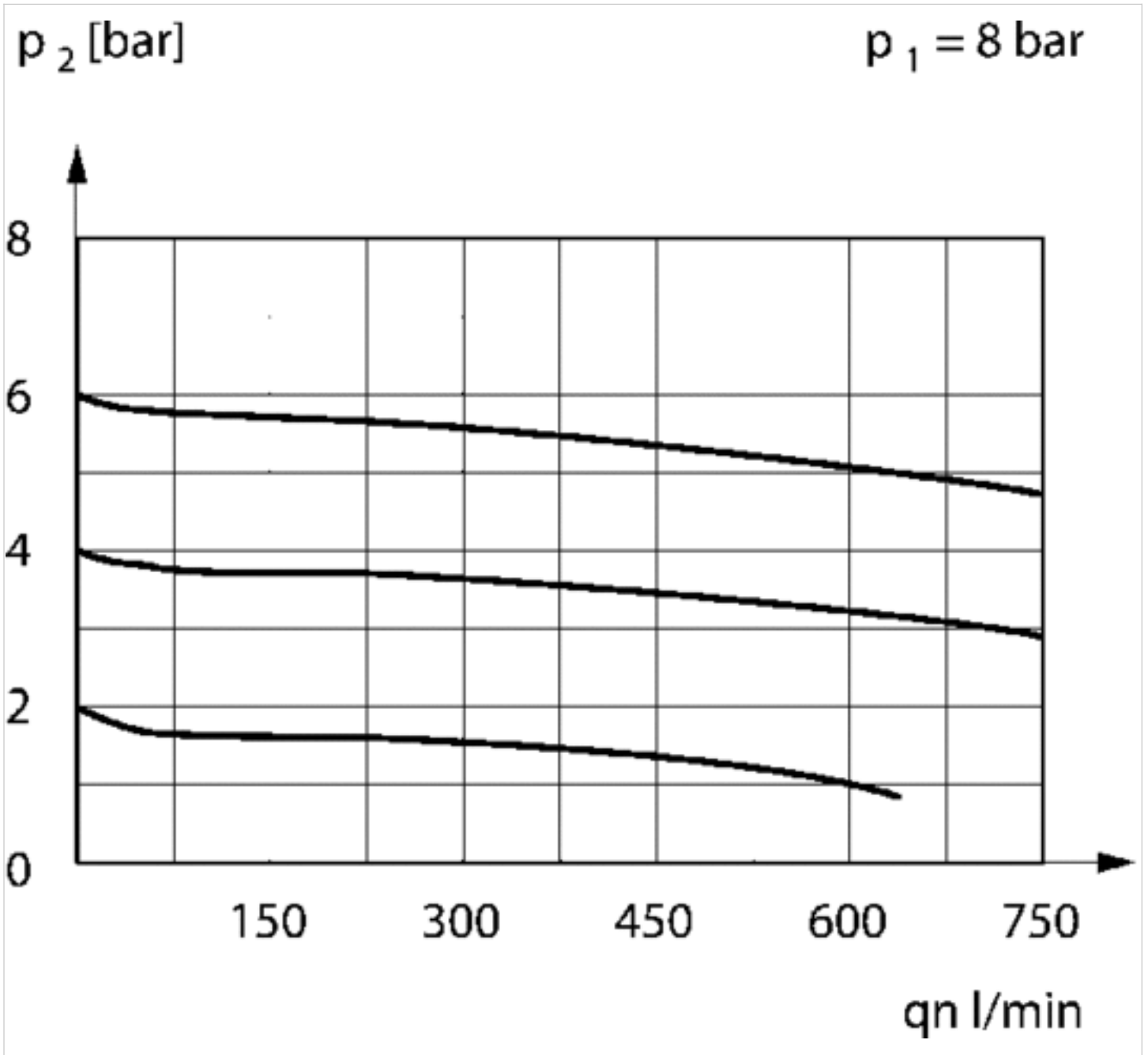

Controlled connection 2/4

# Mecproof, cabinet mounting

- for 581
- size 1
- standard ISO 5599-1



standard	ISO 5599-1
Ambient temperature min./max.	-10 ... 50 °C
Medium	Compressed air
Max. particle size	50 µm
Oil content of compressed air	40 ... 400 mg/m <sup>3</sup>
Weight	See table below

## Technical data

Part No.	Port	Type	Scope of delivery	Weight
5802960000	G 1/2	Intermediate plate for soft-start valve series 583	-	0,63 kg
5802970000	-	Intermediate plate sealing	-	0,03 kg
5802980000	-	Sealing strip incl. assembly instructions	10 piece	0,02 kg
5802950000	G 3/8	End plate	-	0,34 kg

5 connection thread on bottom, 2 connection thread on bottom, for max. 10 intermediate plates



## Dimensions

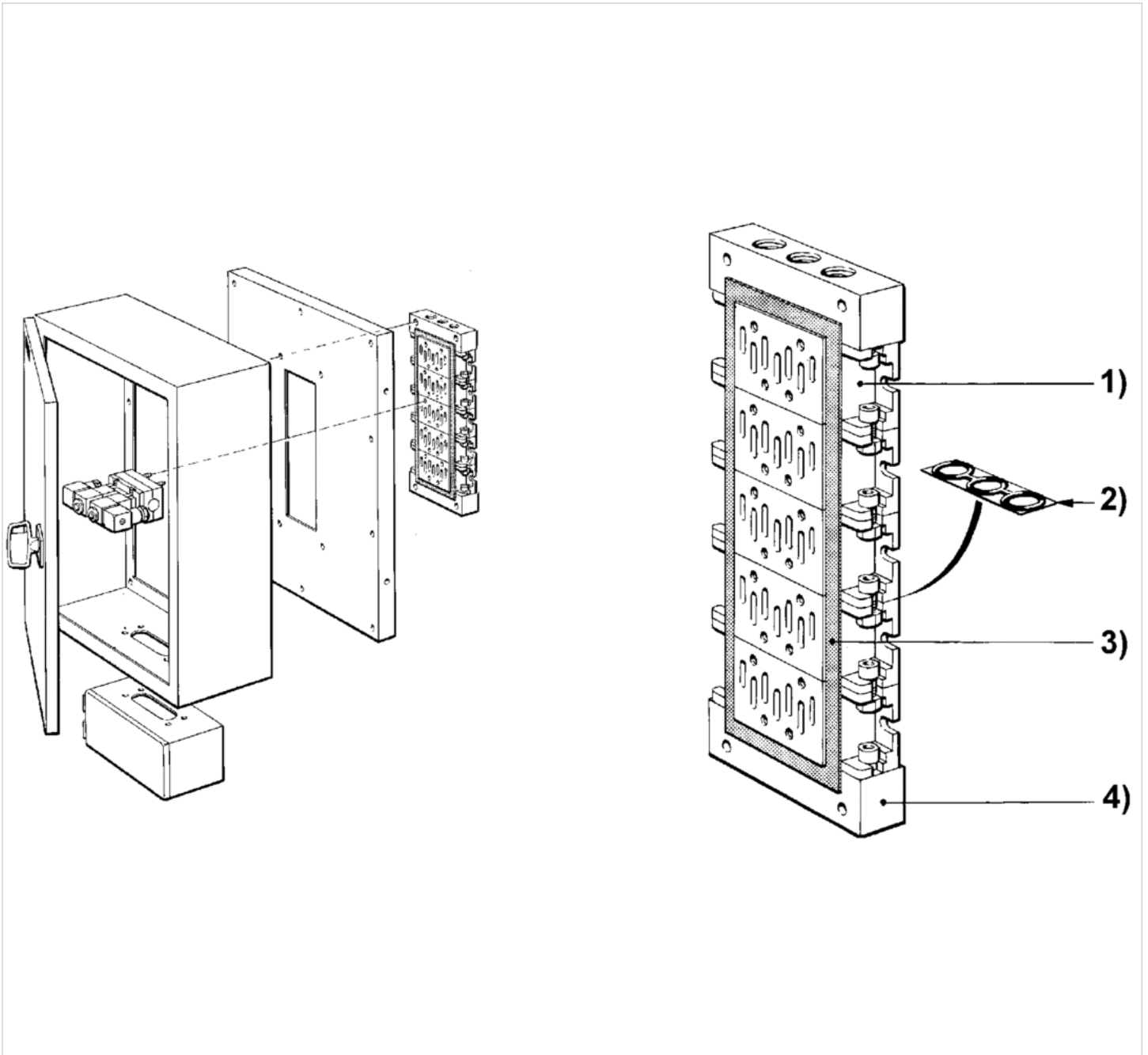

- 1) intermediate plate
- 2) intermediate plate gasket
- 3) sealing strip
- 4) end plate

# Pilot valve

- 581, Modular system
- Manual override without detent

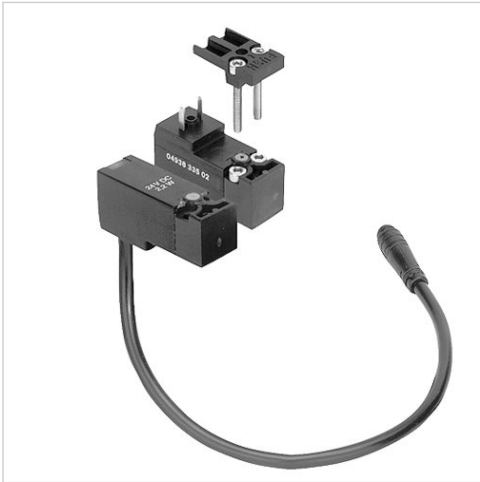

Working pressure min./max.	0 ... 10 bar
Ambient temperature min./max.	-10 ... 50 °C
Medium	Compressed air
Protection class with connection	See table below
LED status display	Green
Duty cycle	100 %
Weight	See table below

## Technical data

Part No.	Operational voltage DC	Power consumption DC	Cable length	Protection class
0493833308	24 V	2,2 W	0,2 m	IP67
0493832506	24 V	2,2 W	0,35 m	IP67
0493833103	24 V	2,2 W	0,5 m	IP67
0493838601	24 V	2,2 W	5 m	IP67
0493833502	24 V	2 W	-	IP65

Part No.	Power consumption	Weight	Fig.	
0493833308	-	0,05 kg	Fig. 1	-
0493832506	-	0,056 kg	Fig. 1	-
0493833103	-	0,058 kg	Fig. 1	-
0493838601	-	0,1 kg	Fig. 1	-
0493833502	Low power consumption	0,04 kg	Fig. 2	1)

1) For valve plug connectors

## Technical information

The min. control pressure must be adhered to, since otherwise faulty switching and valve failure may result!

The pressure dew point must be at least 15 °C under ambient and medium temperature and may not exceed 3 °C .

The oil content of compressed air must remain constant during the life cycle.

Use only the approved oils from AVENTICS. Further information can be found in the "Technical information" document (available in the MediaCentre).

## Dimensions

Fig. 1

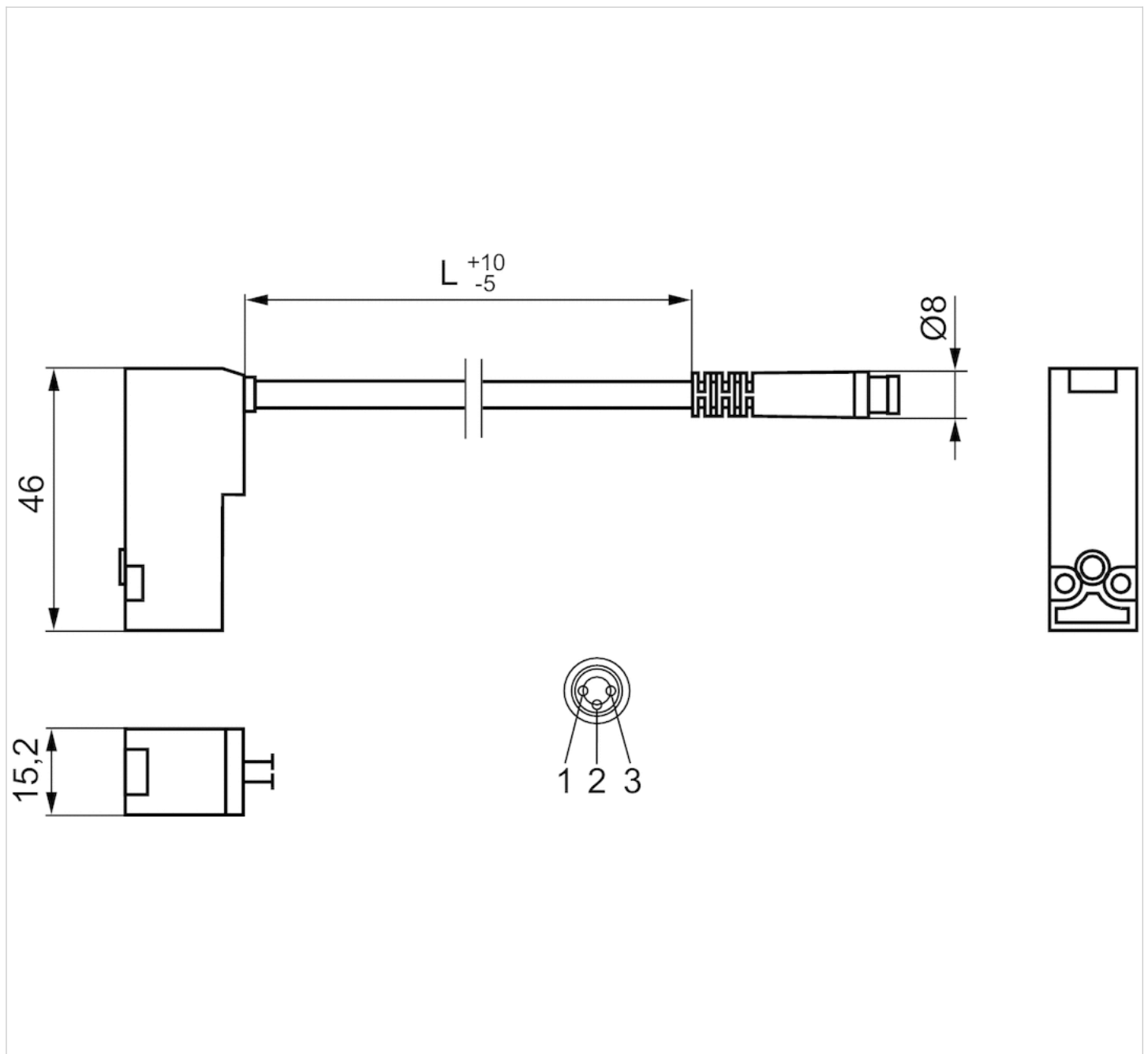

## Pin assignment

- 1) +24 V
- 2) ground
- 3) 0 V

Fig. 2

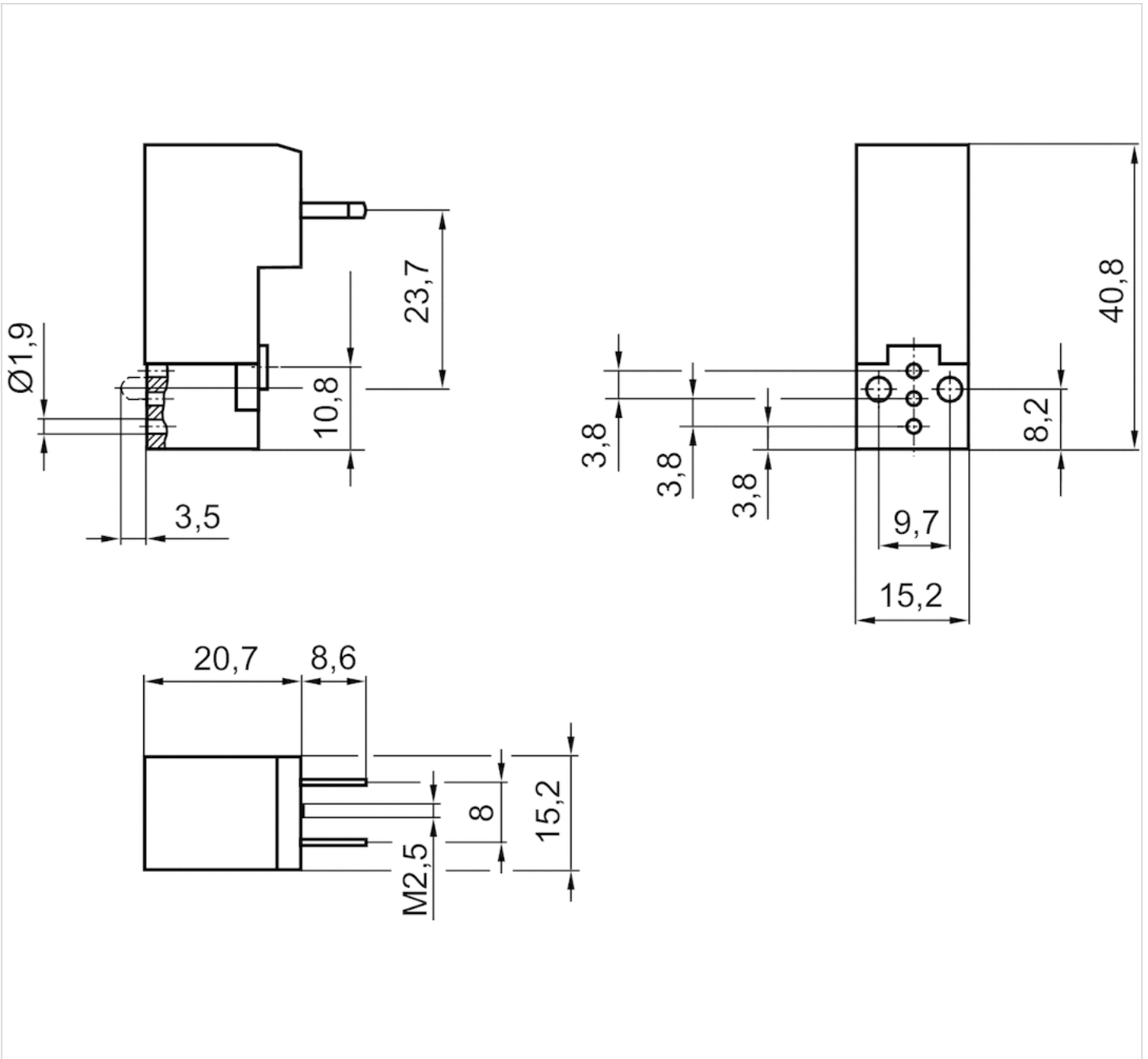

# Control unit for manual override

- for 581

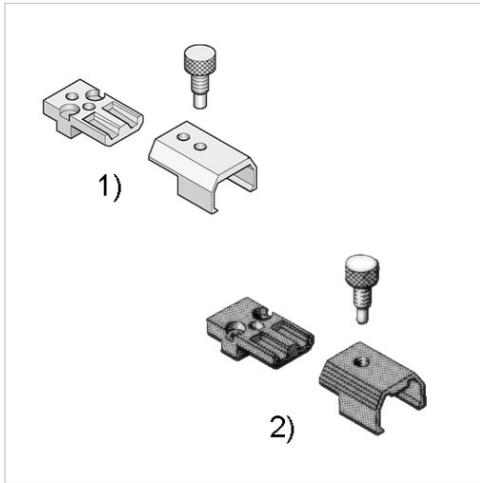

Weight

0,03 kg

An example configuration is illustrated.  
The delivered product may thus deviate  
from the illustration.

## Technical data

Part No.

0493835718

Version as of August 1, 2014, compatible with old applications, Version before August 1, 2014, 6 controls per set

## Dimensions

### Dimensions

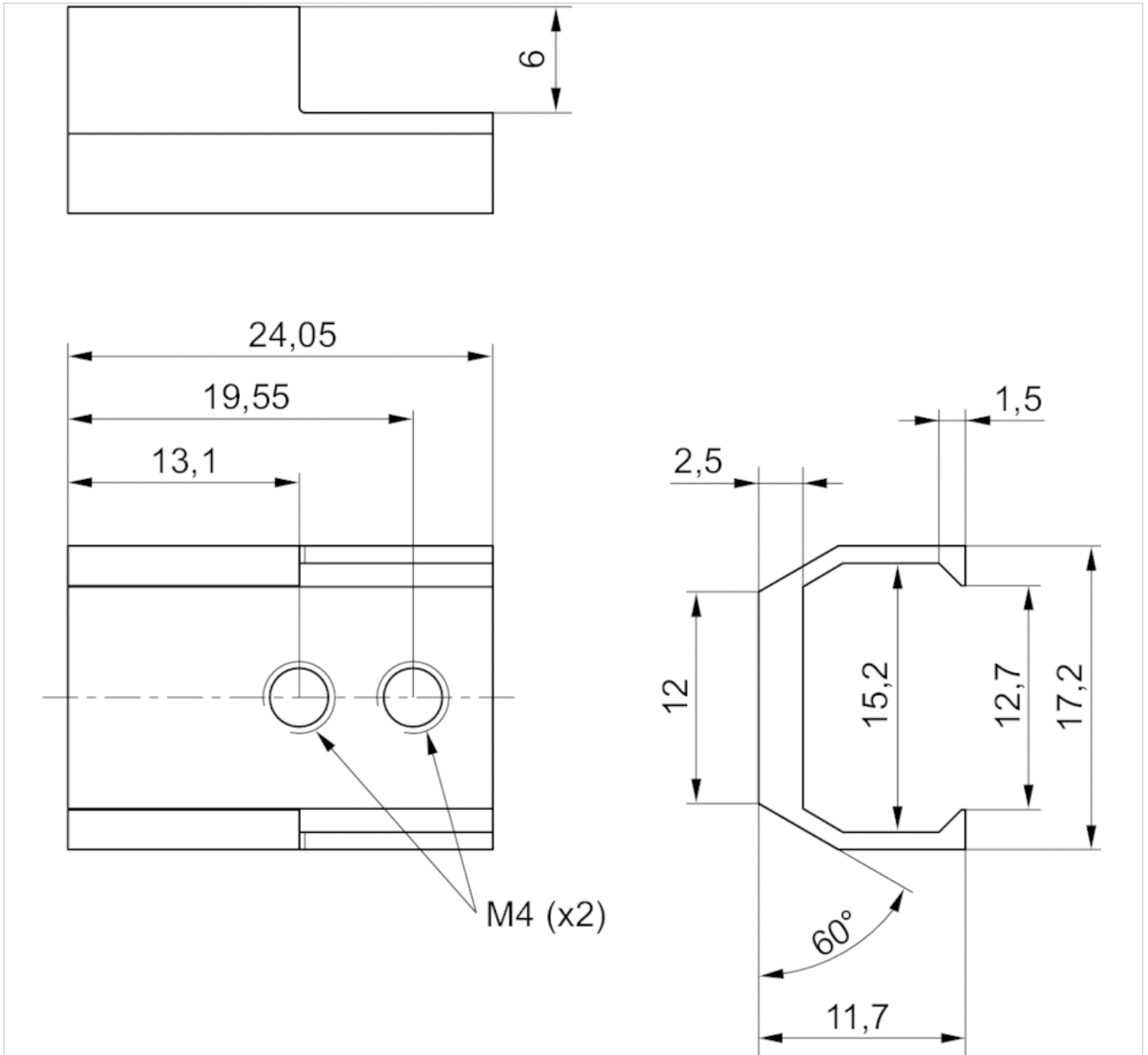

# Pilot valve

- 581, Modular system
- Manual override with detent



Working pressure min./max.	0 ... 10 bar
Ambient temperature min./max.	-15 ... 50 °C
Medium	Compressed air
Protection class with connection	IP65
Duty cycle	100 %
Weight	See table below

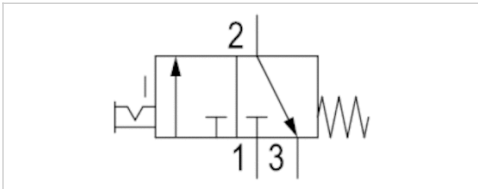

## Technical data

Part No.	Operational voltage DC	Operational voltage AC 50 Hz	Operational voltage AC 60 Hz
0493818805	24 V	230 V	110 V
0493818902	24 V	-	-

Part No.	Power consumption DC	Power consumption	Weight
0493818805	5 W	-	0,031 kg
0493818902	2 W	Low power consumption	0,03 kg

## Technical information

The min. control pressure must be adhered to, since otherwise faulty switching and valve failure may result!  
 The pressure dew point must be at least 15 °C under ambient and medium temperature and may not exceed 3 °C .  
 The oil content of compressed air must remain constant during the life cycle.  
 Use only the approved oils from AVENTICS. Further information can be found in the "Technical information" document (available in the MediaCentre).

## Dimensions

### Dimensions

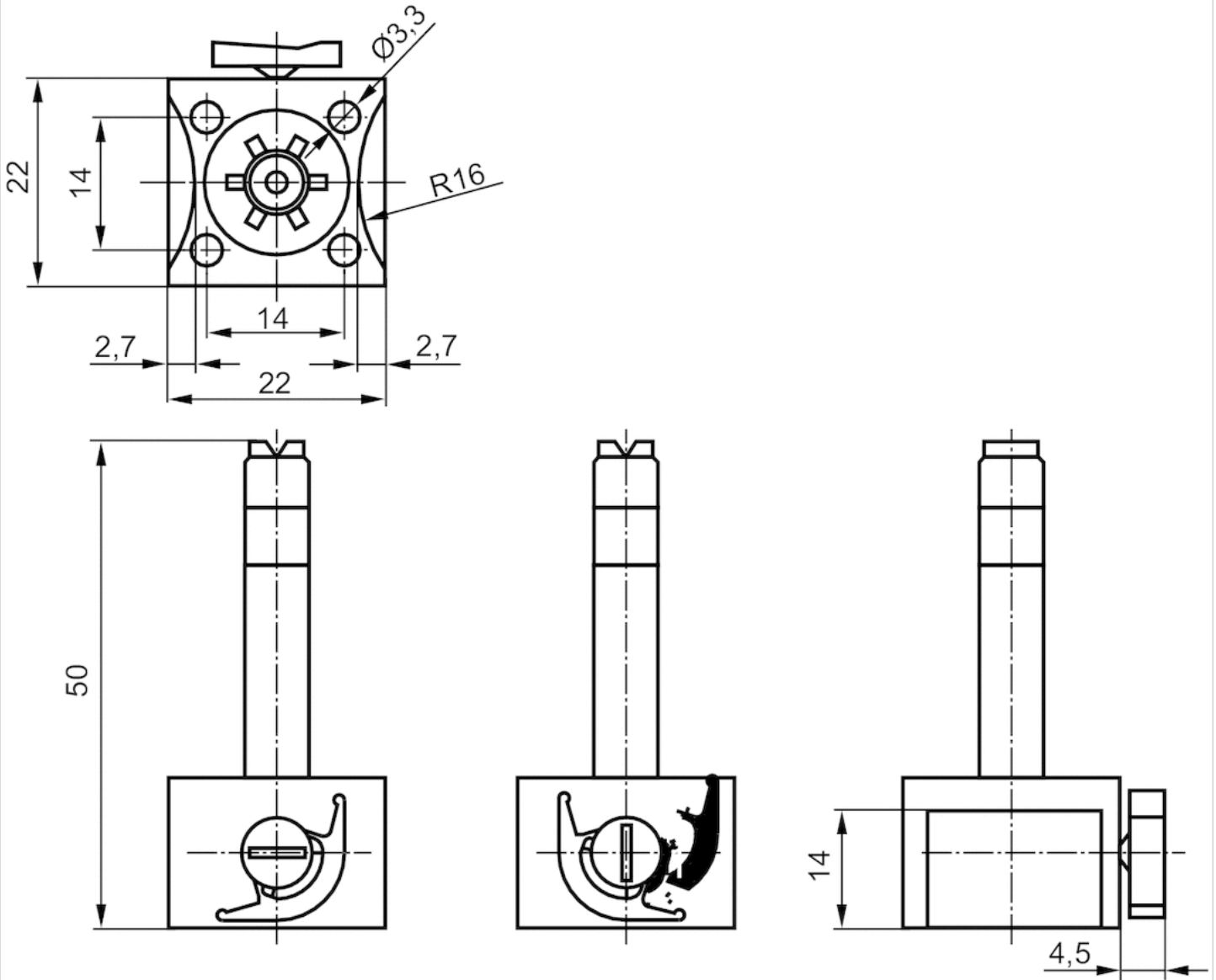



# Coil, Series C01

- Form B, industry
- Coil width 22 mm
- Power consumption DC 2-5 W
- Holding power AC 8 VA
- Switch-on power AC 10 VA



Connector standard  
electrical connections  
Ambient temperature min./max.  
Protection class With valve plug  
connector/plug  
Duty cycle ED  
Weight

ISO 6952  
Plug, Form B, industry  
50 °C  
IP65  
  
100 %  
See table below

An example configuration is illustrated.  
The delivered product may thus deviate  
from the illustration.

## Technical data

Part No.	Operational voltage	Operational voltage	Voltage tolerance
	DC	AC 50 Hz	DC
0498317405	12 V	-	-
0498317502	24 V	-	-10% / +10%
0498318800	24 V	-	-10% / +10%
0498317618	48 V	-	-
0498317707	110 V	-	-10% / +10%
0498317804	220 V	-	-10% / +10%
0498316905	-	24 V	-
0498317006	-	48 V	-
0498317103	-	110 V	-
0498322506	-	230 V	-

Part No.	Voltage tolerance	Power consumption	Holding power	Switch-on power
	AC 50 Hz	DC	AC 50 Hz	AC 50 Hz
0498317405	-	5 W	-	-
0498317502	-	5 W	-	-
0498318800	-	2 W	-	-
0498317618	-	5 W	-	-
0498317707	-	5 W	-	-
0498317804	-	5 W	-	-
0498316905	-10% / +10%	-	8 VA	10 VA
0498317006	-10% / +10%	-	8 VA	10 VA
0498317103	-10% / +10%	-	8 VA	10 VA
0498322506	-10% / +10%	-	8 VA	10 VA

Part No.	Weight	
0498317405	0,054 kg	-
0498317502	0,051 kg	-
0498318800	0,051 kg	1)
0498317618	0,054 kg	-
0498317707	0,054 kg	-
0498317804	0,054 kg	-
0498316905	0,054 kg	-
0498317006	0,054 kg	-
0498317103	0,051 kg	-
0498322506	0,054 kg	-

1) Low power consumption

## Dimensions

### Dimensions

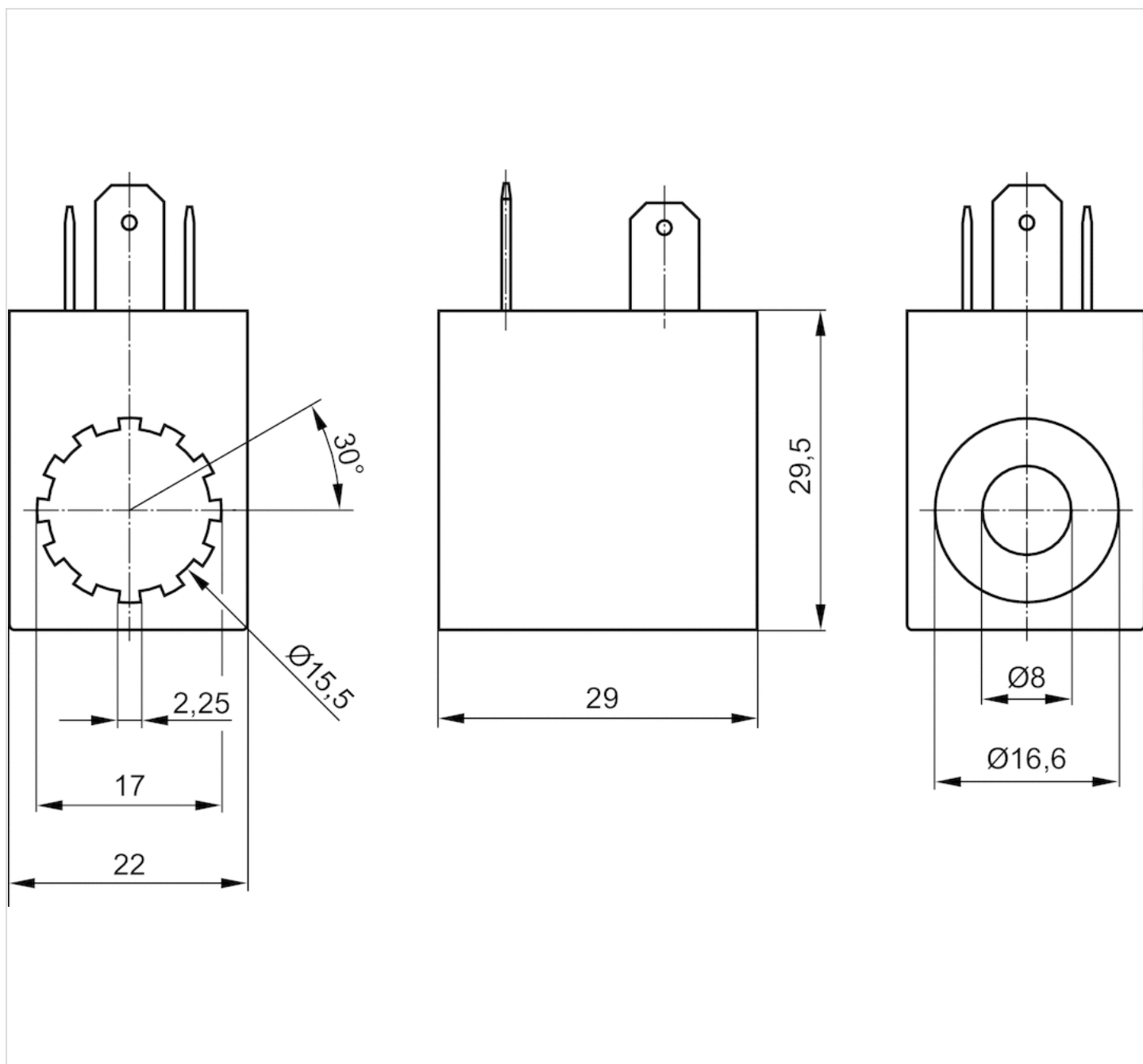

# Pilot valve

- CNOMO / NFE 49-003-1

- 581, Modular system

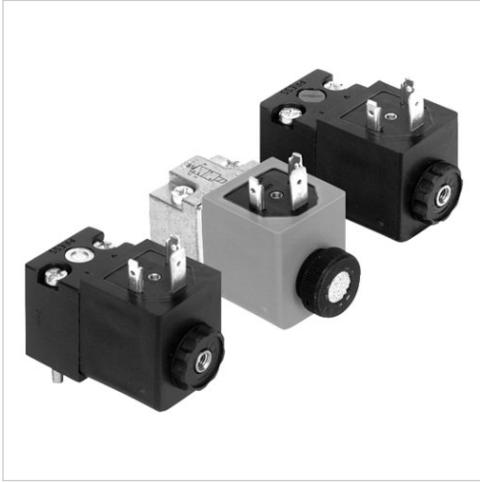

## Standards

Working pressure min./max.

Ambient temperature min./max.

Medium

Protection class with connection

Duty cycle

Weight

CNOMO / NFE 49-003-1

See table below

-10 ... 50 °C

Compressed air



















IP65

100 %

See table below

An example configuration is illustrated.  
The delivered product may thus deviate  
from the illustration.

## Technical data

Part No.		MO	Operational voltage DC	Operational voltage AC 50 Hz
5428110080			-	230 V
5420890020			24 V	-
5420850020		-	24 V	-
5428150080		-	-	230 V
5420890030			48 V	-
5420890070			110 V	-
5420890080			220 V	-
5428110020			-	24 V
5428110040			-	48 V
5428110070			-	110 V

Part No.	Voltage tolerance DC	Voltage tolerance AC 50 Hz	Power consumption DC	Holding power AC 50 Hz
5428110080	-	-20% / +10%	-	8 VA
5420890020	-10% / +10%	-	2 W	-
5420850020	-10% / +10%	-	6,7 W	-
5428150080	-	-20% / +10%	-	8 VA
5420890030	-10% / +10%	-	2 W	-
5420890070	-10% / +10%	-	2 W	-
5420890080	-10% / +10%	-	2 W	-
5428110020	-	-20% / +10%	-	8 VA
5428110040	-	-20% / +10%	-	8 VA
5428110070	-	-20% / +10%	-	8 VA

Part No.	Switch-on power AC 50 Hz	Working pressure min./max.	Power consumption
5428110080	10 VA	0 ... 10 bar	-

Part No.	Switch-on power AC 50 Hz	Working pressure min./max.	Power consumption
5420890020	-	0 ... 10 bar	Low power consumption
5420850020	-	0 ... 16 bar	-
5428150080	10 VA	0 ... 16 bar	-
5420890030	-	0 ... 10 bar	Low power consumption
5420890070	-	0 ... 10 bar	Low power consumption
5420890080	-	0 ... 10 bar	Low power consumption
5428110020	10 VA	0 ... 10 bar	-
5428110040	10 VA	0 ... 10 bar	-
5428110070	10 VA	0 ... 10 bar	-

Part No.	Weight
5428110080	0,17 kg
5420890020	0,17 kg
5420850020	0,206 kg
5428150080	0,162 kg
5420890030	0,17 kg
5420890070	0,17 kg
5420890080	0,17 kg
5428110020	0,17 kg
5428110040	0,17 kg
5428110070	0,17 kg

MO = Manual override, pilot valve 30x22 mm with CNOMO porting configuration

## Technical information

The min. control pressure must be adhered to, since otherwise faulty switching and valve failure may result!

The pressure dew point must be at least 15 °C under ambient and medium temperature and may not exceed 3 °C .

The oil content of compressed air must remain constant during the life cycle.

Use only the approved oils from AVENTICS. Further information can be found in the "Technical information" document (available in the MediaCentre).

# Dimensions

## Dimensions

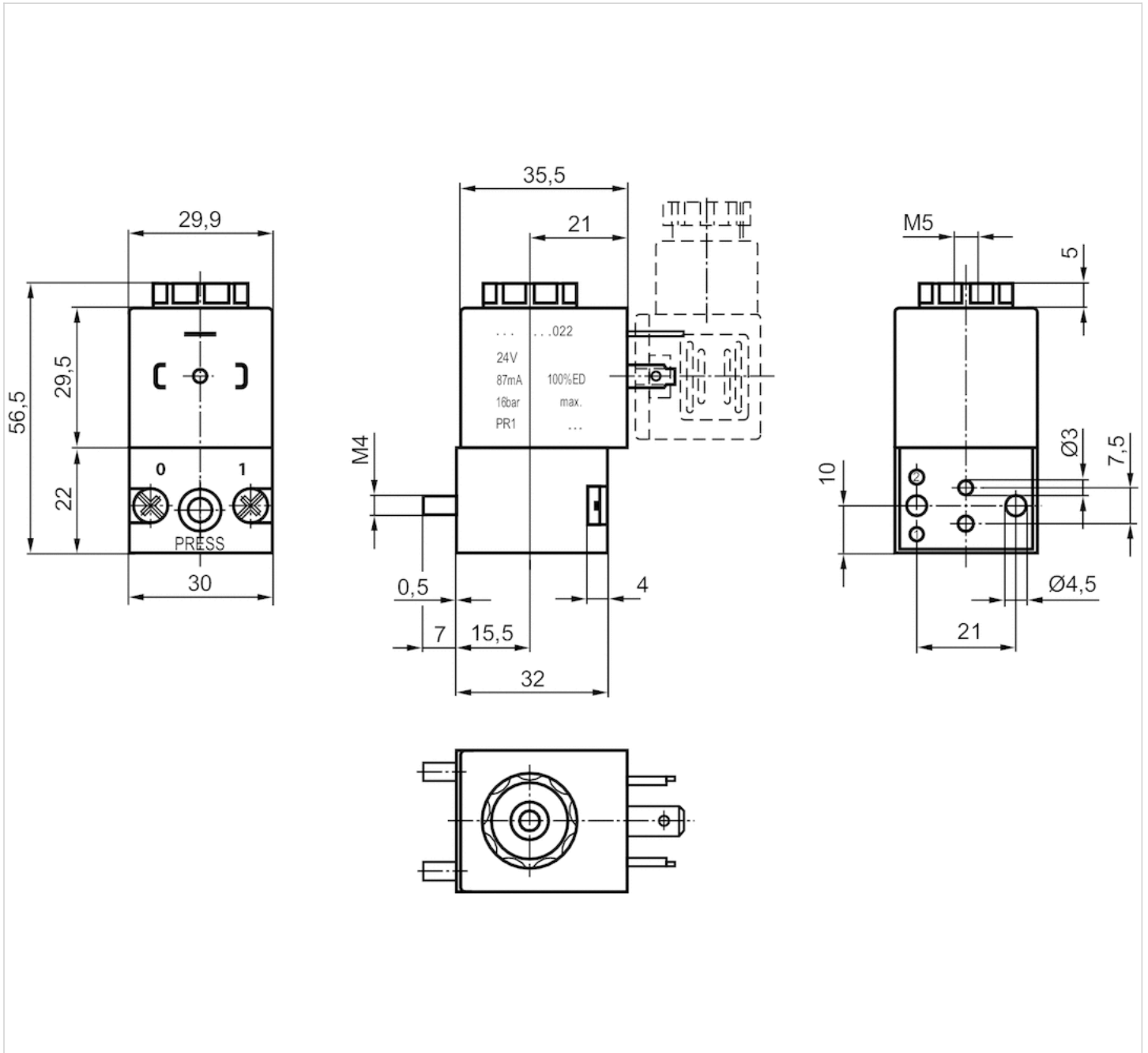

































## 3/2-directional valve, Series DO30

- 3/2
- Pilot valve width : 30 mm
- Plate valve with pipe connection
- Compressed air connection output : CNOMO
- Electrical connection : Plug, EN 175301-803, form A
- Manual override : without detent with detent
- With spring return



Type	Poppet valve
Activation	Electrically
Sealing principle	Soft sealing
Standards	CNOMO / NFE 49-003-1
Working pressure min./max.	0 ... 10 bar
Ambient temperature min./max.	-10 ... 50 °C
Medium temperature min./max.	-10 ... 50 °C
Medium	Compressed air
Max. particle size	5 µm
Oil content of compressed air	0 ... 5 mg/m <sup>3</sup>
Nominal flow 1 ▶ 2	See table below
Nominal flow 2 ▶ 3	See table below
Protection class with connection	IP65
Compatibility index	See table below
Duty cycle	100 %
Mounting on manifold strip	P-strip
mounting screws	M4
Weight	See table below

## Technical data

Part No.		MO	Compressed air connection	
			Input	Output
0820019527			CNOMO	CNOMO
0820019526			CNOMO	CNOMO
0820019529			CNOMO	CNOMO
0820019528			CNOMO	CNOMO
0820019525			CNOMO	CNOMO
0820019985			CNOMO	CNOMO
0820019986			CNOMO	CNOMO
0820019987			M5	CNOMO
0820019982			M5	CNOMO
0820019502			CNOMO	CNOMO
0820019501			CNOMO	CNOMO
0820019504			CNOMO	CNOMO
0820019503			CNOMO	CNOMO
0820019500			CNOMO	CNOMO
0820019980			CNOMO	CNOMO
0820019981			CNOMO	CNOMO

Part No.	Compressed air connection		Operational voltage	
	Exhaust		DC	AC 50 Hz
0820019527	M5		-	24 V
0820019526	M5		24 V	-
0820019529	M5		24 V	-
0820019528	M5		-	-
0820019525	M5		-	230 V
0820019985	M5		-	-
0820019986	M5		-	-
0820019987	CNOMO		-	-
0820019982	CNOMO		-	-
0820019502	M5		-	24 V
0820019501	M5		24 V	-
0820019504	M5		24 V	-
0820019503	M5		-	-
0820019500	M5		-	230 V
0820019980	M5		-	-
0820019981	M5		-	-

Part No.	Operational voltage		Voltage tolerance	
	AC 60 Hz		AC 50 Hz	AC 60 Hz
0820019527	-		-10% / +10%	-
0820019526	-		-	-
0820019529	-		-	-
0820019528	110 V		-	-10% / +10%
0820019525	-		-10% / +10%	-
0820019985	-		-	-
0820019986	-		-	-



Part No.	Operational voltage	Voltage tolerance	
		AC 50 Hz	AC 60 Hz
0820019987	-	-	-
0820019982	-	-	-
0820019502	-	-10% / +10%	-
0820019501	-	-	-
0820019504	-	-	-
0820019503	110 V	-	-10% / +10%
0820019500	-	-10% / +10%	-
0820019980	-	-	-
0820019981	-	-	-

Part No.	Power consumption	Holding power	Holding power	Switch-on power
	DC	AC 50 Hz	AC 60 Hz	AC 50 Hz
0820019527	-	8 VA	-	11,5 VA
0820019526	4,5 W	-	-	-
0820019529	2,7 W	-	-	-
0820019528	-	-	5,6 VA	-
0820019525	-	9,1 VA	-	12,6 VA
0820019985	-	-	-	-
0820019986	-	-	-	-
0820019987	-	-	-	-
0820019982	-	-	-	-
0820019502	-	8 VA	-	11,5 VA
0820019501	4,5 W	-	-	-
0820019504	2,7 W	-	-	-
0820019503	-	-	5,6 VA	-
0820019500	-	9,1 VA	-	12,6 VA
0820019980	-	-	-	-
0820019981	-	-	-	-

Part No.	Switch-on power	Nominal flow 1 ▶ 2	Nominal flow 2 ▶ 3	Compatibility index
	AC 60 Hz			
0820019527	-	68 l/min	90 l/min	15
0820019526	-	68 l/min	90 l/min	15
0820019529	-	54 l/min	80 l/min	14
0820019528	9,5 VA	68 l/min	90 l/min	15
0820019525	-	68 l/min	90 l/min	15
0820019985	-	68 l/min	90 l/min	15
0820019986	-	54 l/min	80 l/min	14
0820019987	-	72 l/min	105 l/min	15
0820019982	-	72 l/min	105 l/min	15
0820019502	-	65 l/min	80 l/min	15
0820019501	-	65 l/min	80 l/min	15
0820019504	-	54 l/min	80 l/min	14
0820019503	9,5 VA	65 l/min	80 l/min	15
0820019500	-	65 l/min	80 l/min	15
0820019980	-	65 l/min	80 l/min	15
0820019981	-	54 l/min	80 l/min	14

Part No.	basic valve with electrical connector	Power consumption	ATEX
0820019527	-	Higher voltage tolerance	-
0820019526	-	Higher voltage tolerance	-
0820019529	-	Low power consumption	-
0820019528	-	Higher voltage tolerance	-
0820019525	-	Higher voltage tolerance	-
0820019985	Basic valve without coil	Higher voltage tolerance	suitable for ATEX
0820019986	Basic valve without coil	Low power consumption	suitable for ATEX
0820019987	Basic valve without coil	Higher voltage tolerance	suitable for ATEX
0820019982	Basic valve without coil	Higher voltage tolerance	suitable for ATEX
0820019502	-	Higher voltage tolerance	-
0820019501	-	Higher voltage tolerance	-
0820019504	-	Low power consumption	-
0820019503	-	Higher voltage tolerance	-
0820019500	-	Higher voltage tolerance	-
0820019980	Basic valve without coil	Higher voltage tolerance	suitable for ATEX
0820019981	Basic valve without coil	Low power consumption	suitable for ATEX

Part No.	Weight	
0820019527	0,16 kg	-
0820019526	0,16 kg	-
0820019529	0,16 kg	-
0820019528	0,16 kg	-
0820019525	0,16 kg	-
0820019985	0,06 kg	1)
0820019986	0,07 kg	-
0820019987	0,08 kg	-
0820019982	0,06 kg	-
0820019502	0,16 kg	-
0820019501	0,16 kg	-
0820019504	0,16 kg	-
0820019503	0,16 kg	-
0820019500	0,16 kg	-
0820019980	0,06 kg	1)
0820019981	0,06 kg	-

Nominal flow Qn at 6 bar and  $\Delta p = 1$  bar, MO = Manual override

1) pilot valve without coil

## Technical information

The min. control pressure must be adhered to, since otherwise faulty switching and valve failure may result!

The pressure dew point must be at least 15 °C under ambient and medium temperature and may not exceed 3 °C .

The oil content of compressed air must remain constant during the life cycle.

Use only the approved oils from AVENTICS. Further information can be found in the "Technical information" document (available in the MediaCentre).

## Technical information

### Material

Housing	Plastic
Seals	Fluorocaoutchouc

## Dimensions

### Dimensions

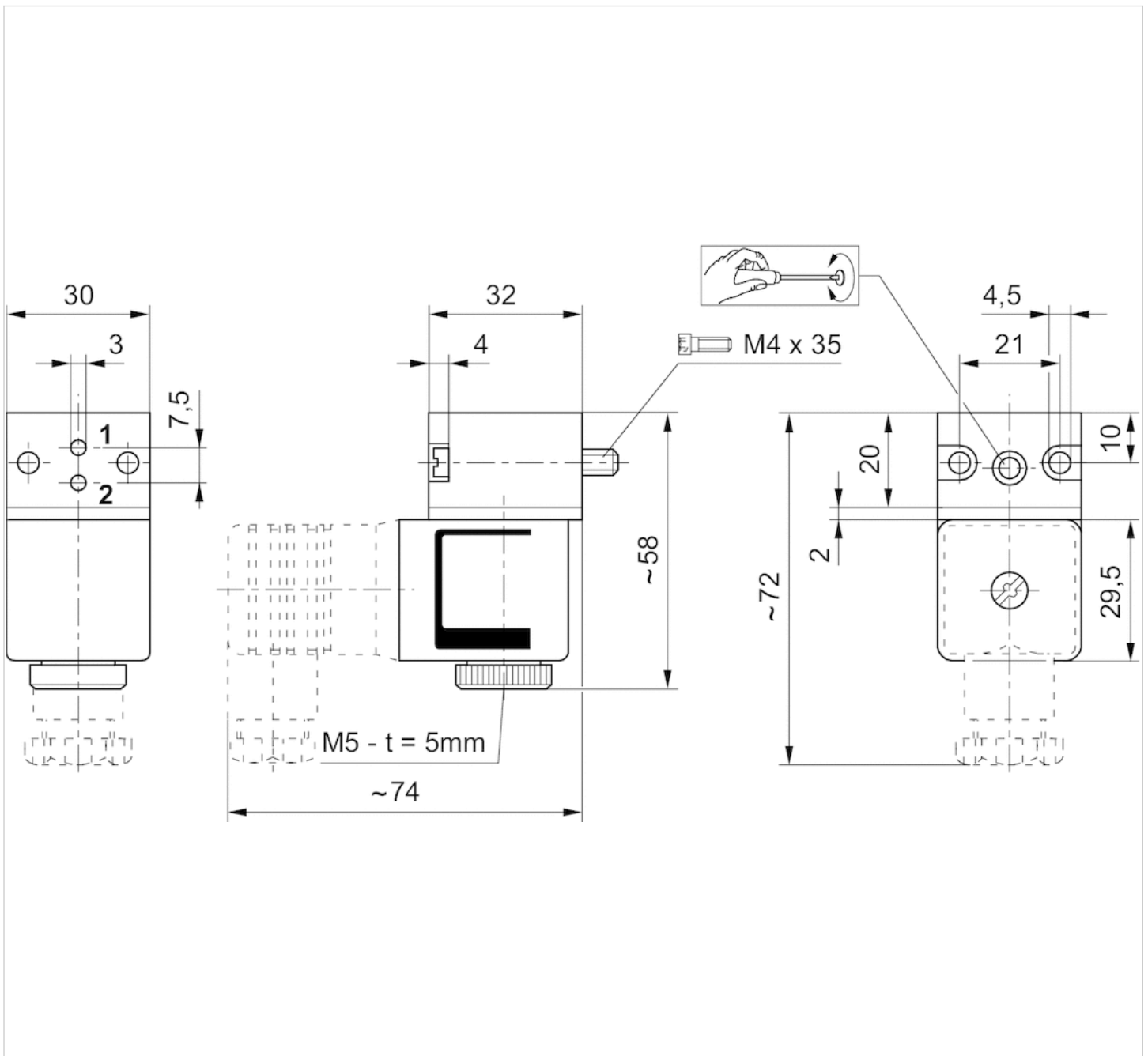

t = depth

# 3/2-directional valve

- Manual override : without detent



Activation

Working pressure min./max.

Ambient temperature min./max.

Medium

Weight

Electrically

0 ... 16 bar

-10 ... 50 °C

Compressed air Compressed air

0,15 kg

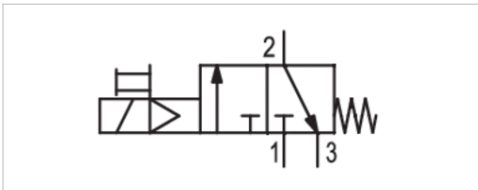

## Technical data

Part No.	Operational voltage		Voltage tolerance
	DC	AC 50 Hz	DC
5420800390	24 V	42 V	-10% / +10%
5428200380	-	230 V	-
5428200370	-	110 V	-

Part No.	Voltage tolerance	Power consumption	Holding power	Switch-on power
	AC 50 Hz	DC	AC 50 Hz	AC 50 Hz
5420800390	-20% / +10%	6,7 W	-	-
5428200380	-20% / +10%	-	8 VA	10 VA
5428200370	-20% / +10%	-	8 VA	10 VA

Nominal flow  $Q_n$  with secondary pressure 6 bar at  $\Delta p = 1$  bar

## Technical information

The min. control pressure must be adhered to, since otherwise faulty switching and valve failure may result!

The pressure dew point must be at least 15 °C under ambient and medium temperature and may not exceed 3 °C .

The oil content of compressed air must remain constant during the life cycle.

Use only the approved oils from AVENTICS. Further information can be found in the "Technical information" document (available in the MediaCentre).

# Dimensions

## Dimensions

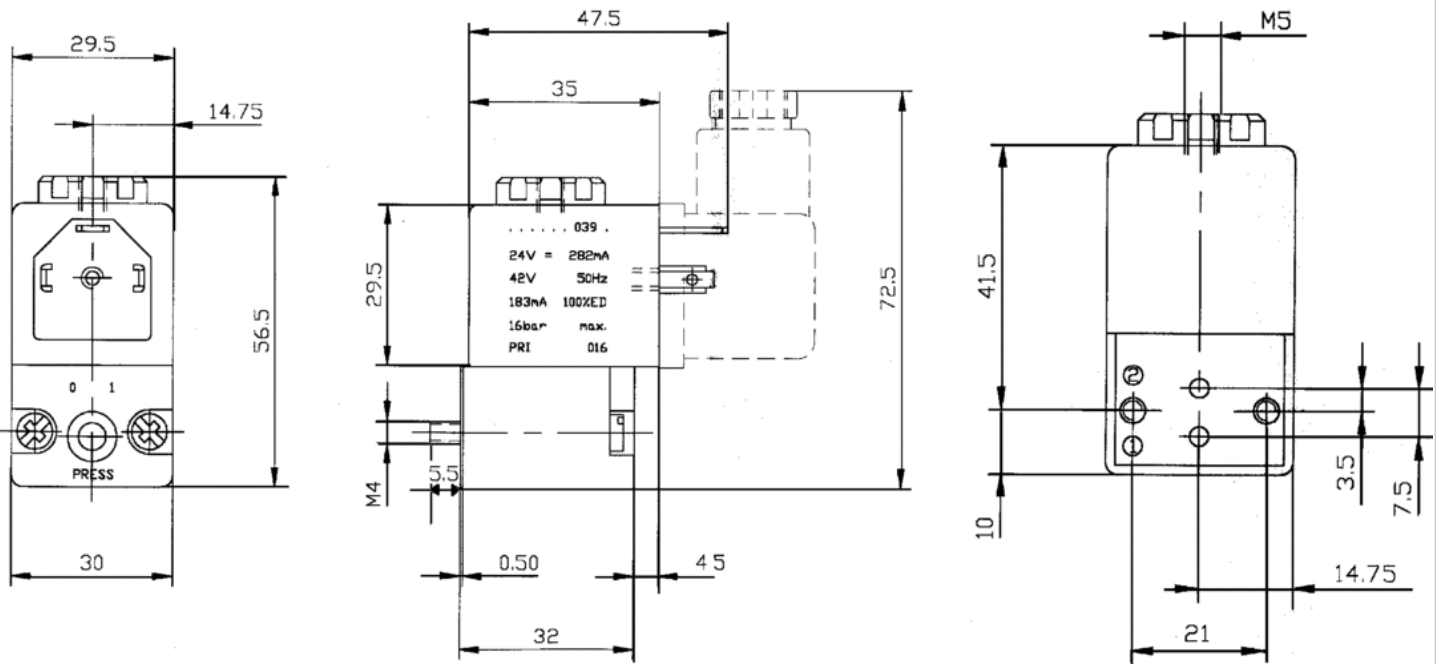

# Coil, Series CO1

- Cable with valve plug connector
- Coil width 30 mm
- Power consumption DC 3.25 W
- Holding power AC 2.9-3 VA
- Switch-on power AC 3-3.1 VA
- ATEX

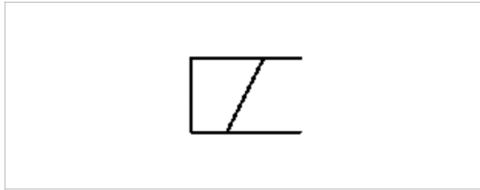

Certificates	ATEX
ATEX class G	II 2G Ex mb IIC T4 Gb
ATEX class D	II 2D Ex mb tb IIIC T130°C Db IP65
Ambient temperature min./max.	-20 ... 50 °C
Protection class	IP65
Duty cycle ED	100 %
Compatibility index	14
Weight	See table below

## Technical data

Part No.	Operational voltage		Operational voltage
	DC	AC 50 Hz	AC 60 Hz
1827414297	-	230 V	230 V
1827414298	-	230 V	230 V
1827414299	-	110 V	110 V
1827414301	-	24 V	24 V
1827414303	24 V	-	-
1827414304	24 V	-	-

Part No.	Voltage tolerance		Power consumption		Holding power	
	DC	AC 50 Hz	DC	AC 50 Hz	DC	AC 50 Hz
1827414297	-	-10% / +10%	-	-	-	3 VA
1827414298	-	-10% / +10%	-	-	-	3 VA
1827414299	-	-10% / +10%	-	-	-	2,9 VA
1827414301	-	-10% / +10%	-	-	-	2,9 VA
1827414303	-10% / +10%	-	3,25 W	-	-	-
1827414304	-10% / +10%	-	3,25 W	-	-	-

Part No.	Switch-on power		Cable length	Weight
	AC 50 Hz			
1827414297	3,1 VA		3 m	0,38 kg

Part No.	Switch-on power	Cable length	Weight
	AC 50 Hz		
1827414298	3,1 VA	10 m	0,91 kg
1827414299	3 VA	3 m	0,38 kg
1827414301	3 VA	3 m	0,38 kg
1827414303	-	3 m	0,38 kg
1827414304	-	10 m	0,91 kg

## Dimensions

### Dimensions

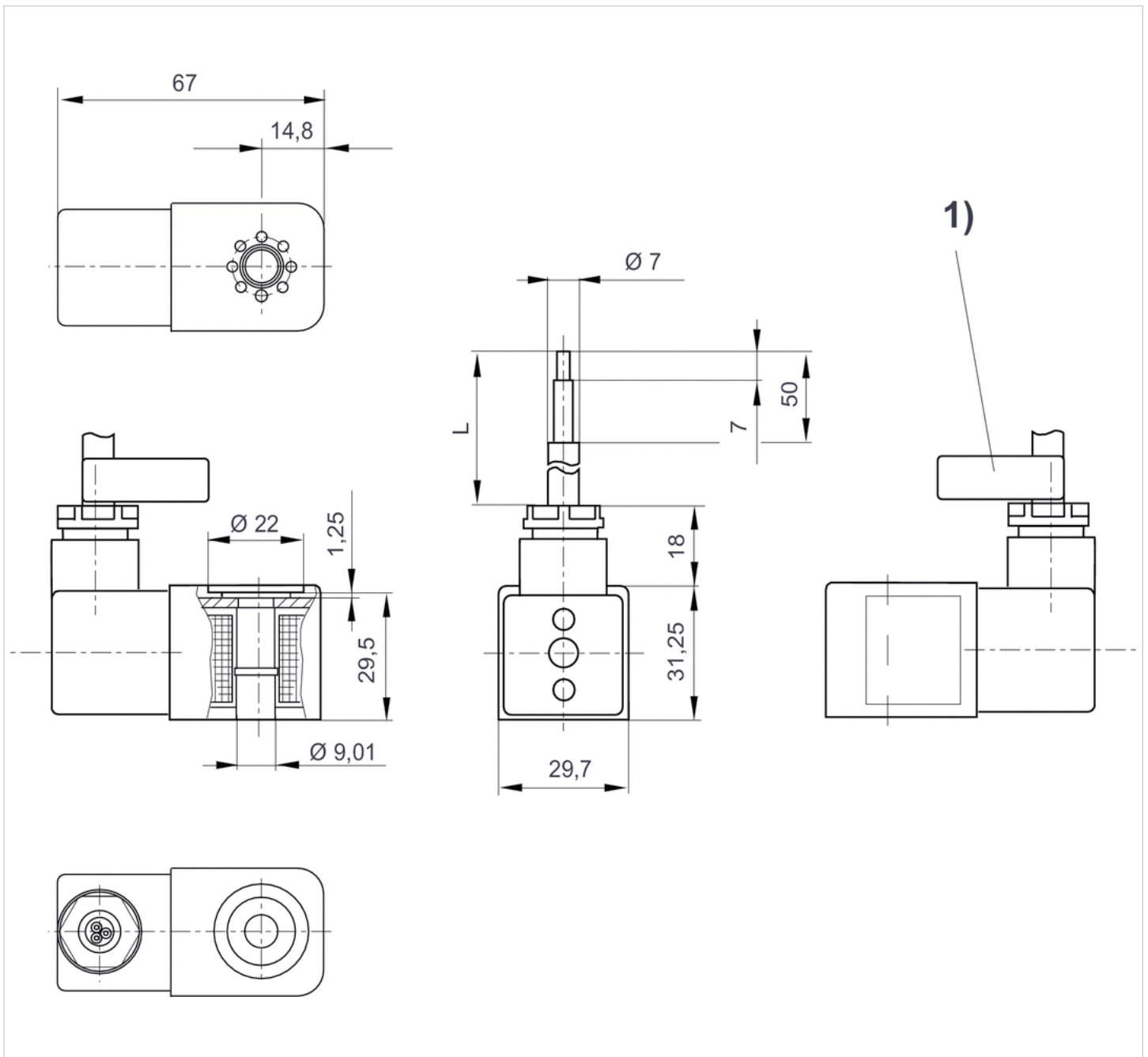

L = cable length

1) Cable ID band with serial number

# Soft-start valve





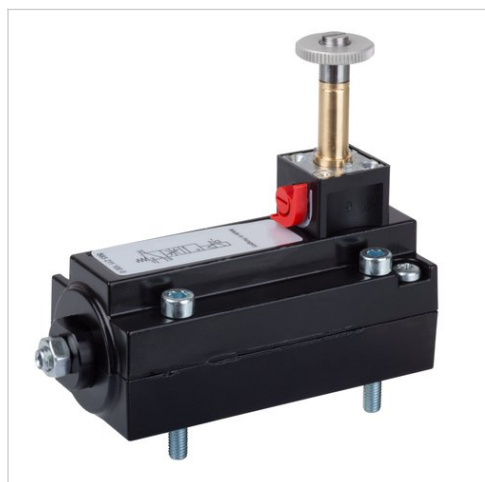



















- Qn = 3300 l/min

- Manual override with detent



Type	Spool valve
Working pressure min./max.	3 ... 10 bar
Ambient temperature min./max.	-15 ... 50 °C
Medium temperature min./max.	-15 ... 50 °C
Medium	Compressed air
Max. particle size	5 µm
Oil content of compressed air	0 ... 1 mg/m <sup>3</sup>
Nominal flow Qn	3300 l/min
Flow conductance C	11,3 l/(s*bar)
Protection class with connection	IP65
Duty cycle	100 %
Typ. switch-off time	60 ms
Weight	0,39 kg

## Technical data

Part No.		MO	Operational voltage DC	Operational voltage AC 50 Hz
5832111200			-	24 V
5832115200			-	24 V
5832151100			24 V	-
5832155100			24 V	-
5832111100			24 V	-
5832115100			24 V	-
5832111300			-	-
5832115300			-	-
5832111400			-	230 V
5832115400			-	230 V
5832111000			-	-
5832115000			-	-

Part No.	Operational voltage AC 60 Hz	Voltage tolerance DC	Voltage tolerance AC 50 Hz	Voltage tolerance AC 60 Hz
5832111200	-	-	-10% / +10%	-
5832115200	-	-	-10% / +10%	-
5832151100	-	-10% / +10%	-	-
5832155100	-	-10% / +10%	-	-
5832111100	-	-10% / +10%	-	-
5832115100	-	-10% / +10%	-	-
5832111300	110 V	-	-	-10% / +10%
5832115300	110 V	-	-	-10% / +10%
5832111400	-	-	-10% / +10%	-
5832115400	-	-	-10% / +10%	-



Part No.	Operational voltage AC 60 Hz	Voltage tolerance DC	Voltage tolerance AC 50 Hz	Voltage tolerance AC 60 Hz
5832111000	-	-	-	-
5832115000	-	-	-	-

Part No.	Power consumption DC	Holding power AC 50 Hz	Holding power AC 60 Hz	Switch-on power AC 50 Hz
5832111200	-	8 VA	-	10 VA
5832115200	-	8 VA	-	10 VA
5832151100	2 W	-	-	-
5832155100	2 W	-	-	-
5832111100	5 W	-	-	-
5832115100	5 W	-	-	-
5832111300	-	-	8 VA	-
5832115300	-	-	8 VA	-
5832111400	-	8 VA	-	10 VA
5832115400	-	8 VA	-	10 VA
5832111000	-	-	-	-
5832115000	-	-	-	-

Part No.	Switch-on power AC 60 Hz	
5832111200	-	1)
5832115200	-	2)
5832151100	-	3)
5832155100	-	4)
5832111100	-	1)
5832115100	-	2)
5832111300	10 VA	1)
5832115300	10 VA	2)
5832111400	-	1)
5832115400	-	2)
5832111000	-	1)
5832115000	-	-

MO = Manual override

- 1) Pilot valve on top
- 2) Pilot valve on side
- 3) Pilot valve on top, Low power consumption
- 4) Pilot valve on side, Low power consumption

## Technical information

The min. control pressure must be adhered to, since otherwise faulty switching and valve failure may result!

The pressure dew point must be at least 15 °C under ambient and medium temperature and may not exceed 3 °C .

The oil content of compressed air must remain constant during the life cycle.

Use only the approved oils from AVENTICS. Further information can be found in the "Technical information" document (available in the MediaCentre).

## Technical information

Housing	Aluminum
Seals	Acrylonitrile butadiene rubber

## Dimensions

### Dimensions

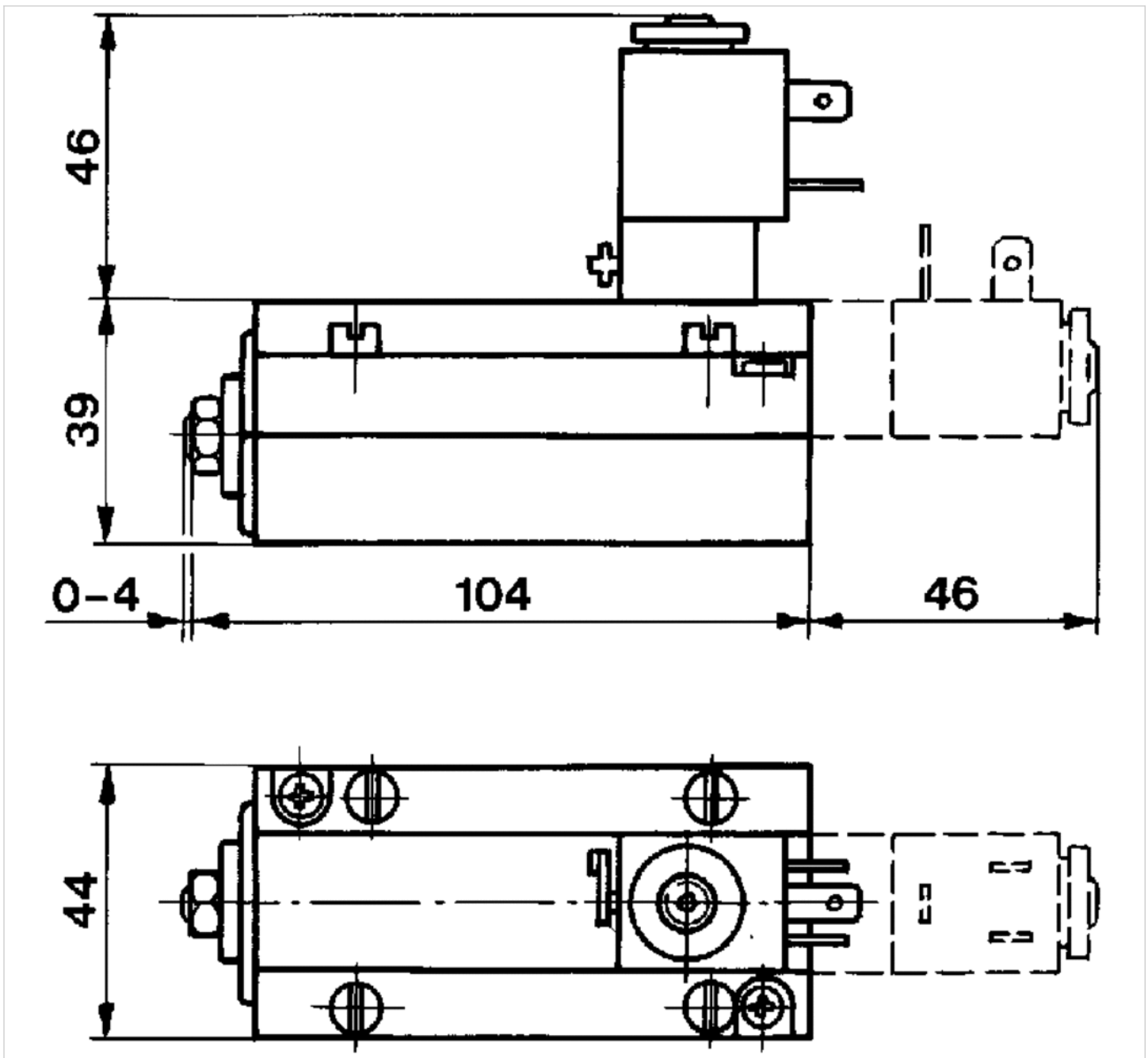

# Soft-start valve











- Qn = 3300 l/min

- Manual override without detent with detent without



Type	Spool valve
Working pressure min./max.	3 ... 10 bar
Ambient temperature min./max.	-15 ... 50 °C
Medium temperature min./max.	-15 ... 50 °C
Medium	Compressed air
Max. particle size	5 µm
Oil content of compressed air	0 ... 1 mg/m <sup>3</sup>
Nominal flow Qn	3300 l/min
Flow conductance C	11,3 l/(s*bar)
Protection class with connection	IP65
Duty cycle	100 %
Typ. switch-off time	60 ms
Weight	0,39 kg

## Technical data

Part No.		MO	Operational voltage DC	Operational voltage AC 50 Hz
5832171540			24 V	-
5832171440			-	230 V
5832171650			24 V	-
5832171450			-	230 V
5832171530		-	24 V	-
5832171430		-	-	230 V

Part No.	Voltage tolerance DC	Voltage tolerance AC 50 Hz	Power consumption DC	Holding power AC 50 Hz
5832171540	-10% / +10%	-	6,7 W	-
5832171440	-	-10% / +10%	-	8 VA
5832171650	-10% / +10%	-	2 W	-
5832171450	-	-10% / +10%	-	8 VA
5832171530	-10% / +10%	-	6,7 W	-
5832171430	-	-10% / +10%	-	8 VA

Part No.	Switch-on power AC 50 Hz
5832171540	-
5832171440	10 VA
5832171650	-
5832171450	10 VA
5832171530	-
5832171430	10 VA

MO = Manual override

## 1) Low power consumption

## Technical information

The min. control pressure must be adhered to, since otherwise faulty switching and valve failure may result!

The pressure dew point must be at least 15 °C under ambient and medium temperature and may not exceed 3 °C .

The oil content of compressed air must remain constant during the life cycle.

Use only the approved oils from AVENTICS. Further information can be found in the "Technical information" document (available in the MediaCentre).

## Technical information

Housing	Aluminum
Seals	Acrylonitrile butadiene rubber

## Dimensions

### Dimensions

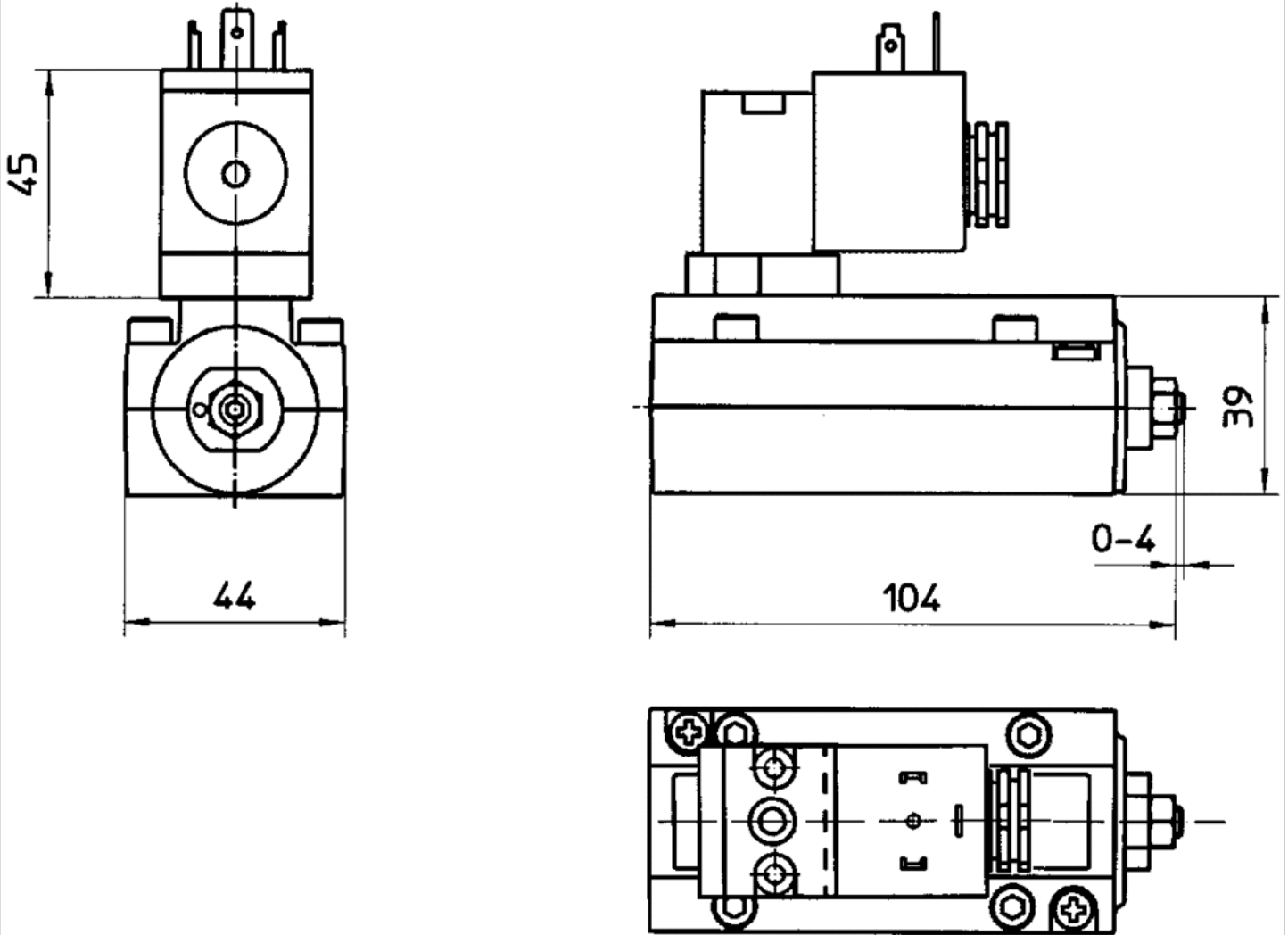

# Soft-start valve

- Qn = 3300 l/min



Type	Spool valve
Standards	ISO 1
Nominal flow Qn	3300 l/min
Working pressure min./max.	3 ... 10 bar
Ambient temperature min./max.	-15 ... 50 °C
Medium temperature min./max.	-15 ... 50 °C
Medium	Compressed air class 6-4-3
Max. particle size	5 µm
Oil content of compressed air	0 ... 5 mg/m <sup>3</sup>
Weight	0,39 kg

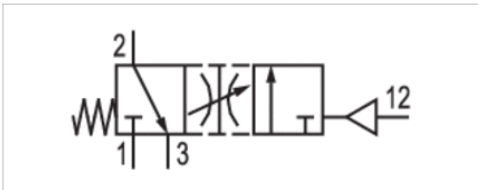

## Technical data

Part No.	Flow conductance
	C-value
5832131000	11,3 l/(s*bar)

## Technical information

The min. control pressure must be adhered to, since otherwise faulty switching and valve failure may result!  
 The pressure dew point must be at least 15 °C under ambient and medium temperature and may not exceed 3 °C .  
 The oil content of compressed air must remain constant during the life cycle.  
 Use only the approved oils from AVENTICS. Further information can be found in the "Technical information" document (available in the MediaCentre).

## Technical information

Housing	Aluminum
Seals	Acrylonitrile butadiene rubber

Dimensions

Dimensions

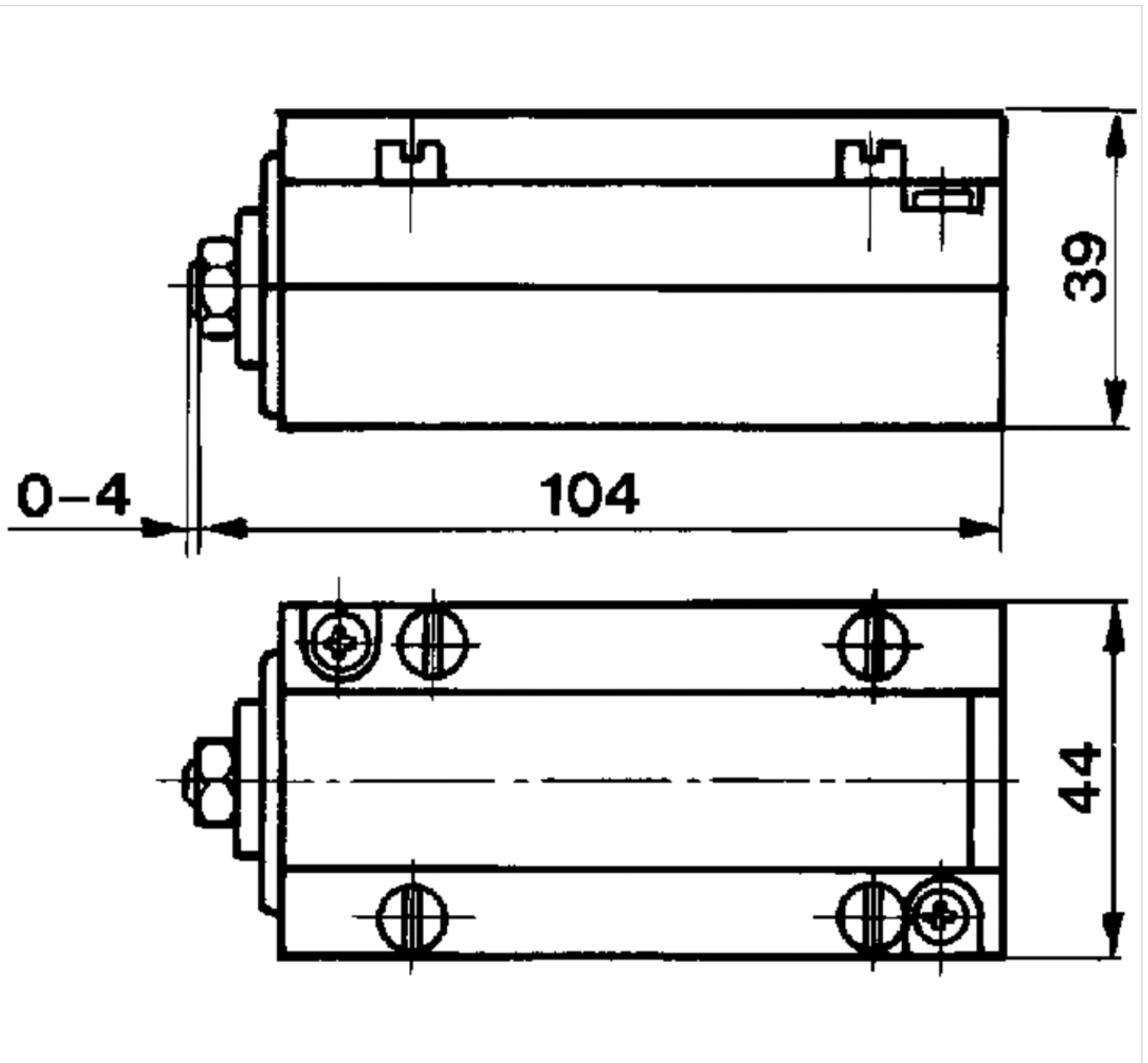

# Valve plug connector, series CON-VP

- Socket, 2+E, angled, 90° Socket, 3+E, angled, 90°

- EN 175301-803

- unshielded

- with LED Yellow Red Green green/red



Connection type

Ambient temperature min./max.

Operational voltage

Protection class

Mounting screw tightening torque

Weight

Screws

-40 ... 90 °C







See table below

IP65

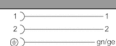
0,4 Nm

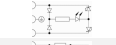
See table below

## Technical data

Part No.		Electrical connection	Operational voltage	Max. current
		1		
1834484048		Socket 2+E angled 90°	-	10 A
1834484059		Socket 3+E angled 90°	-	10 A
1834484101		Socket 2+E angled 90°	24 V AC/DC	-
1834484102		Socket 2+E angled 90°	110 V AC	-
1834484103		Socket 2+E angled 90°	230 V AC	-
8941016112		Socket 2+E angled 90°	230 V AC	-
8941012462		Socket 3+E angled 90°	24 V DC	8 A

Part No.	Protective circuit	Contact assignment	LED status display	suitable cable-Ø min./max
1834484048	-	2+E	-	6 / 8 mm
1834484059	-	3+E	-	6 / 8 mm
1834484101	Z-diode	2+E	Yellow	6 / 8 mm
1834484102	Varistor	2+E	Red	6 / 8 mm
1834484103	Varistor	2+E	Red	6 / 8 mm
8941016112	Varistor	2+E	Green	6 / 10 mm
8941012462	-	3+E	green/red	4,5 / 11 mm

Part No.	Seal	Weight	
1834484048	caoutchouc/butadiene caoutchouc	0,03 kg	1)
1834484059	caoutchouc/butadiene caoutchouc	0,03 kg	1)
1834484101	Silicone caoutchouc	0,03 kg	2)
1834484102	caoutchouc/butadiene caoutchouc	0,03 kg	1)
1834484103	Silicone caoutchouc	0,025 kg	1)
8941016112	caoutchouc/butadiene caoutchouc	0,03 kg	1)
8941012462	caoutchouc/butadiene caoutchouc	0,03 kg	2)



- 1) Profile seal
- 2) Flat gasket

## Technical information

The specified protection class is only valid in assembled and tested state.

## Technical information

Material	
Seals	caoutchouc/butadiene caoutchouc Silicone caoutchouc

## Dimensions

## Dimensions

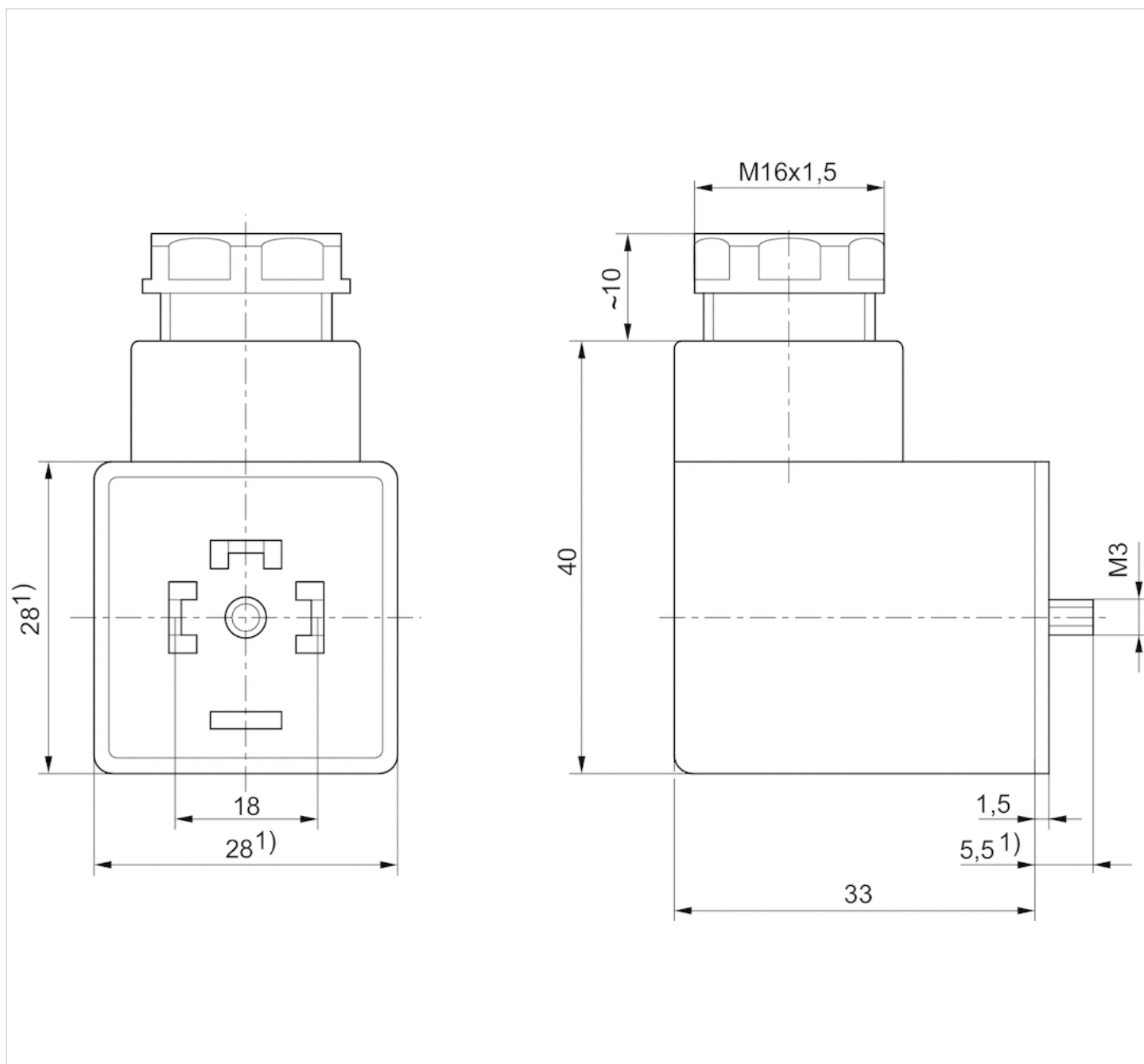

1) Max.





# Valve plug connector, series CON-VP

- Socket form A 2+E angled 90°
- open cable ends 3-pin
- with cable
- unshielded



Ambient temperature min./max.	-20 ... 80 °C
Operational voltage	See table below
Protection class	IP67
Wire cross-section	0,75 mm <sup>2</sup>
Mounting screw tightening torque	0,4 Nm
Weight	See table below

## Technical data

Part No.		Operational voltage	Protective circuit	Contact assignment	LED status display
1834484160		230 V AC/DC	-	2+E	-
1834484162		24 V AC/DC	Z-diode	2+E	Yellow
1834484163		24 V AC/DC	Z-diode	2+E	Yellow
1834484164		230 V AC/DC	Varistor	2+E	Red
1834484165		230 V AC/DC	Varistor	2+E	Red

Part No.	Number of wires	Cable-Ø	Cable length	Weight	Fig.	
1834484160	3	5,9 mm	3 m	0,2 kg	Fig. 1	1)
1834484162	3	5,9 mm	3 m	0,2 kg	Fig. 2	-
1834484163	3	5,9 mm	5 m	0,31 kg	Fig. 2	-
1834484164	3	5,9 mm	3 m	0,2 kg	Fig. 2	-
1834484165	3	5,9 mm	5 m	0,31 kg	Fig. 2	-

1) Scope of delivery incl. flat gasket

## Technical information

The specified protection class is only valid in assembled and tested state.

## Technical information

Material	
Seals	caoutchouc/butadiene caoutchouc
Cable sheath	Polyvinyl chloride

# Dimensions

Fig. 1

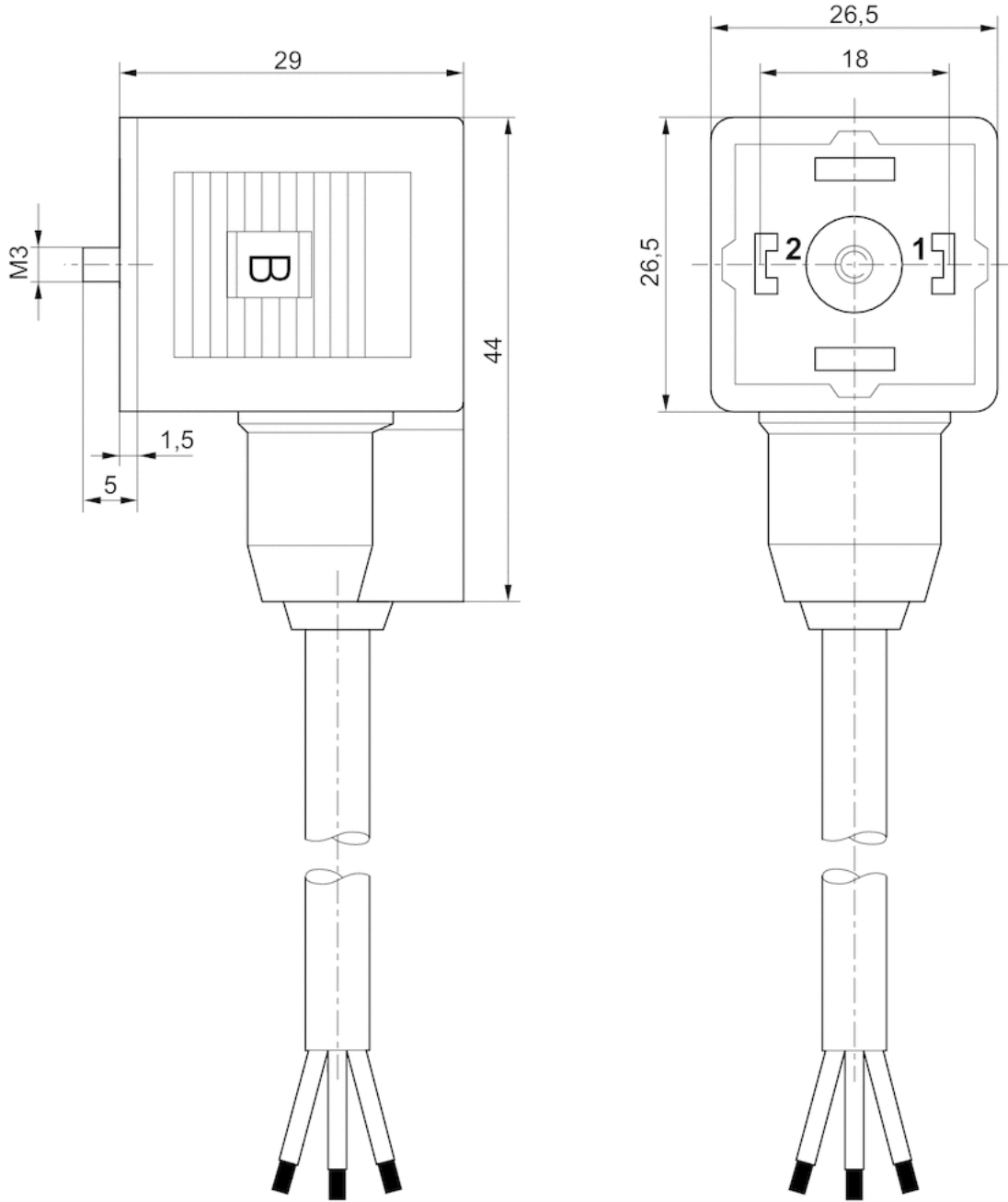
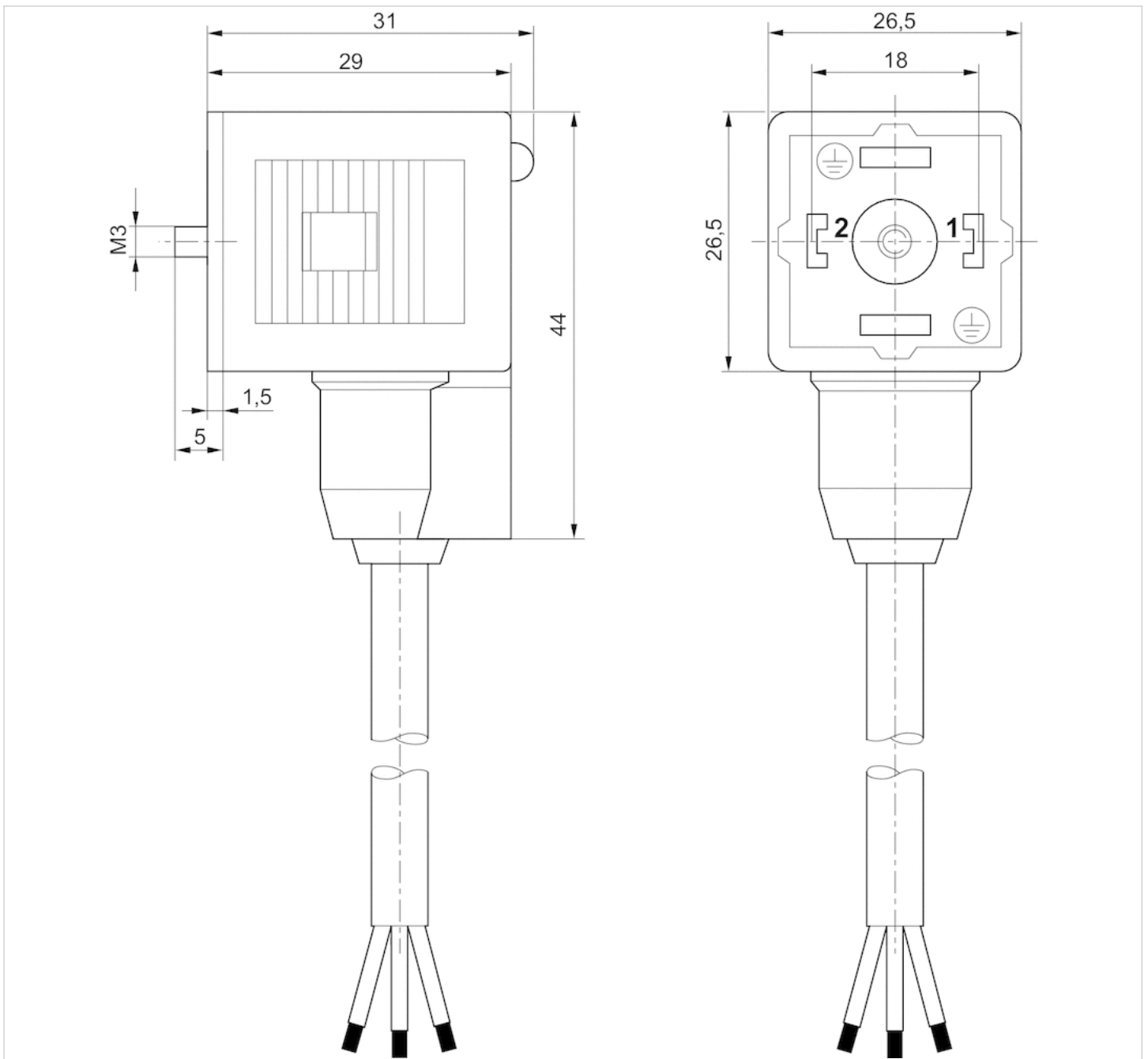

Fig. 2







# Valve plug connector, series CON-VP

- Socket, Form B, industry, 2+E, angled, 90°
- Industry standard
- unshielded
- with LED Yellow Red

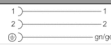

Connection type	Screws
Ambient temperature min./max.	-25 ... 50 °C
Operational voltage	See table below
Protection class	IP65
Mounting screw tightening torque	0,4 Nm
Weight	0,02 kg

## Technical data

Part No.		Operational voltage	Max. current	Protective circuit	Contact assignment
1834484051		-	10 A	-	2+E
1834484107		24 V AC/DC	-	Z-diode	2+E
1834484108		110 V AC	-	Varistor	2+E
1834484109		230 V AC	-	Varistor	2+E

Part No.	LED status display	suitable cable-Ø min./max	Seal	Fig.	
1834484051	-	4 / 8 mm	caoutchouc/butadiene caoutchouc	Fig. 1	1)
1834484107	Yellow	6 / 8 mm	Silicone caoutchouc	Fig. 2	2)
1834484108	Red	6 / 8 mm	Silicone caoutchouc	Fig. 2	1)
1834484109	Red	4 / 8 mm	Silicone caoutchouc	Fig. 2	2)

1) Profile seal

2) Flat gasket,

## Technical information

For security reasons, the valve plug connector must be plugged properly and centrally.  
The specified protection class is only valid in assembled and tested state.

## Technical information

Material	
Seals	caoutchouc/butadiene caoutchouc Silicone caoutchouc

## Dimensions

Fig. 1

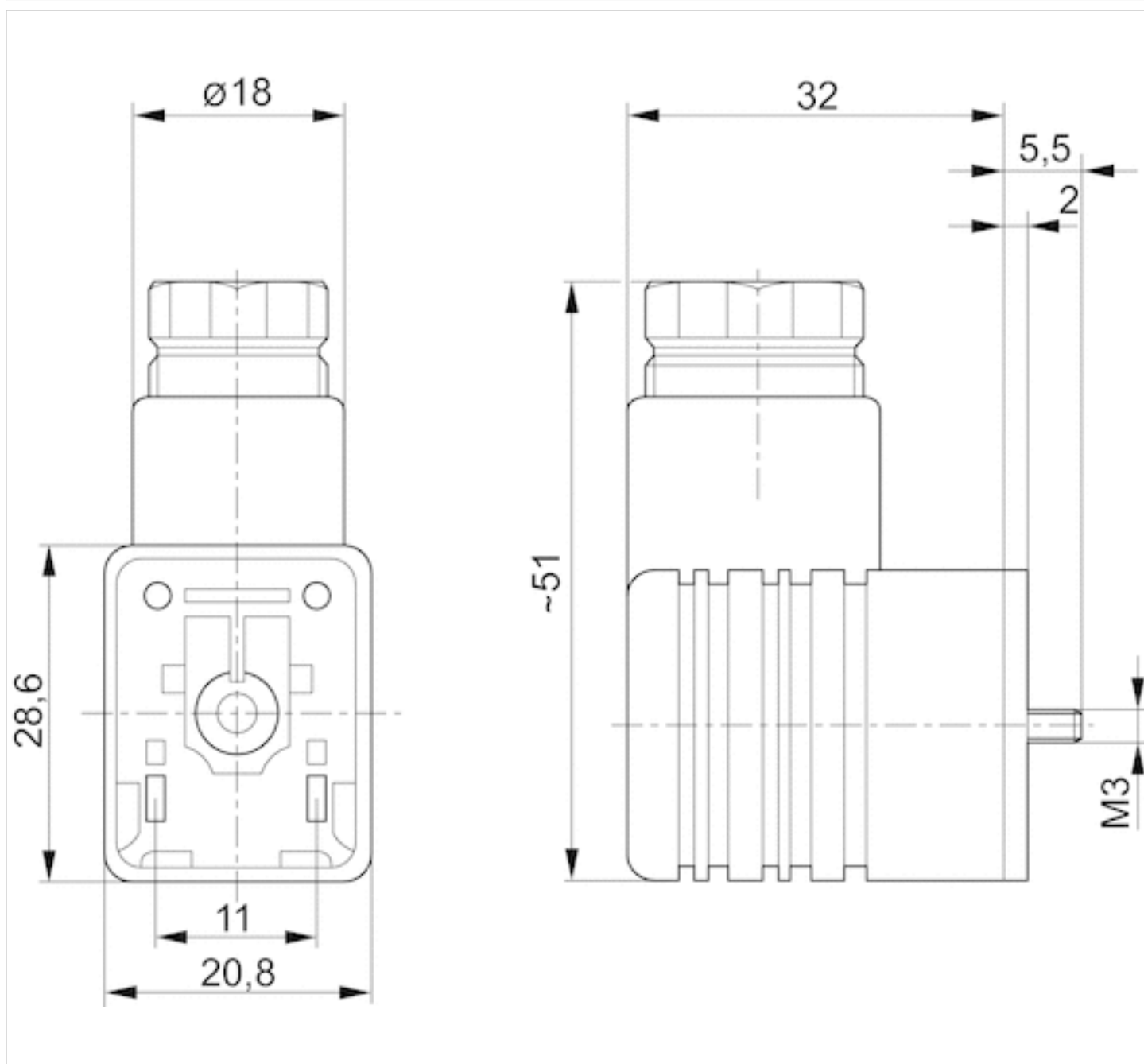
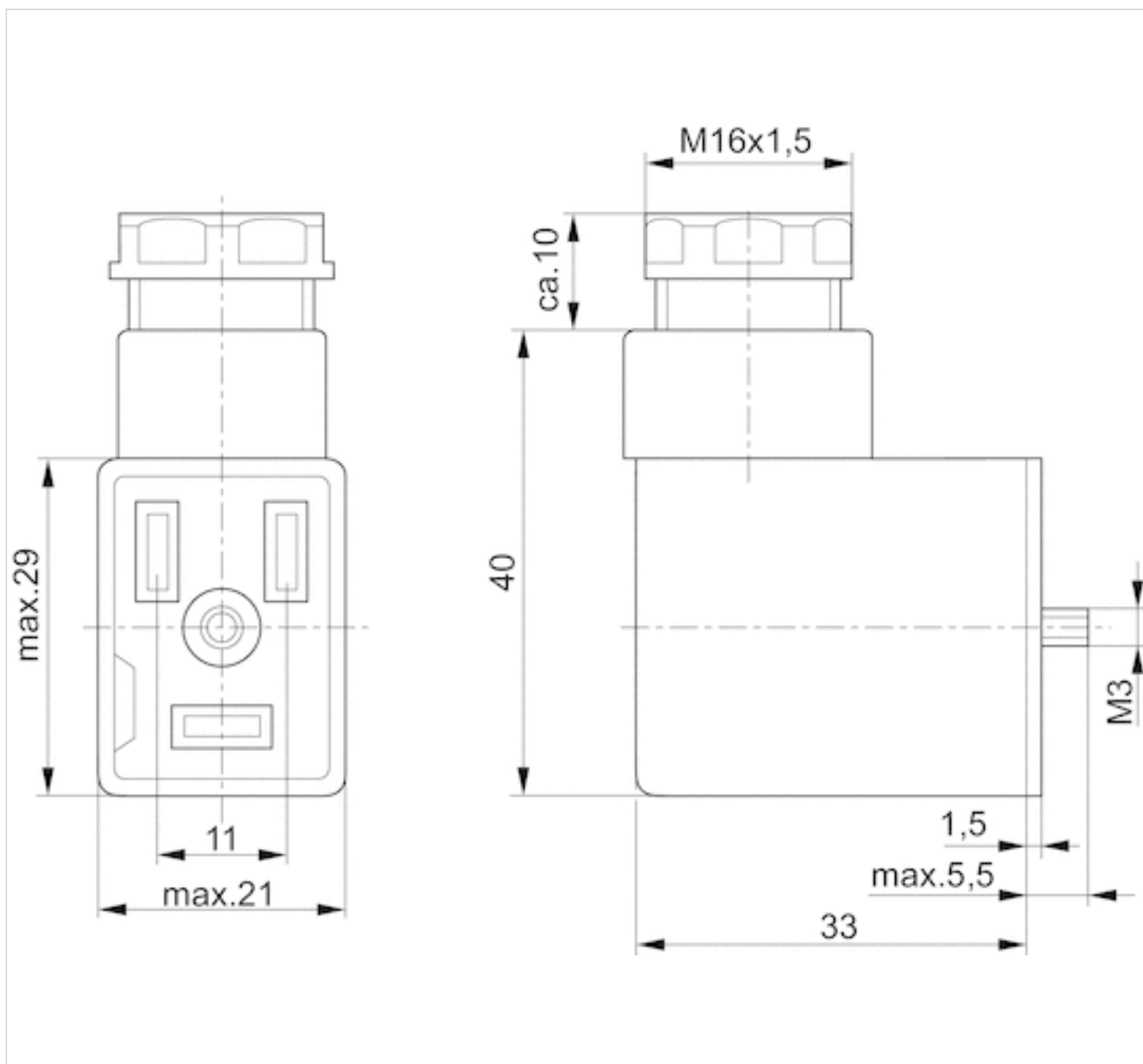

Fig. 2





# Valve plug connector, series CON-VP

- Socket Form B, industry 2+E angled 90°
- open cable ends 3-pin
- with cable
- unshielded



Ambient temperature min./max.	-20 ... 80 °C
Protection class	IP67
Wire cross-section	0,75 mm <sup>2</sup>
Mounting screw tightening torque	0,4 Nm
Weight	0,02 kg

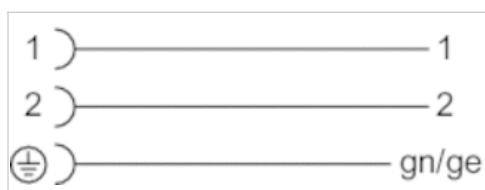

## Technical data

Part No.	Max. current	Contact assignment	Number of wires	Cable-Ø	Cable length
8946201912	4 A	2+E	3	5,9 mm	3 m

## Technical information

For security reasons, the valve plug connector must be plugged properly and centrally.  
The specified protection class is only valid in assembled and tested state.

## Technical information

### Material

Cable sheath	Polyvinyl chloride
--------------	--------------------

## Dimensions

## Dimensions

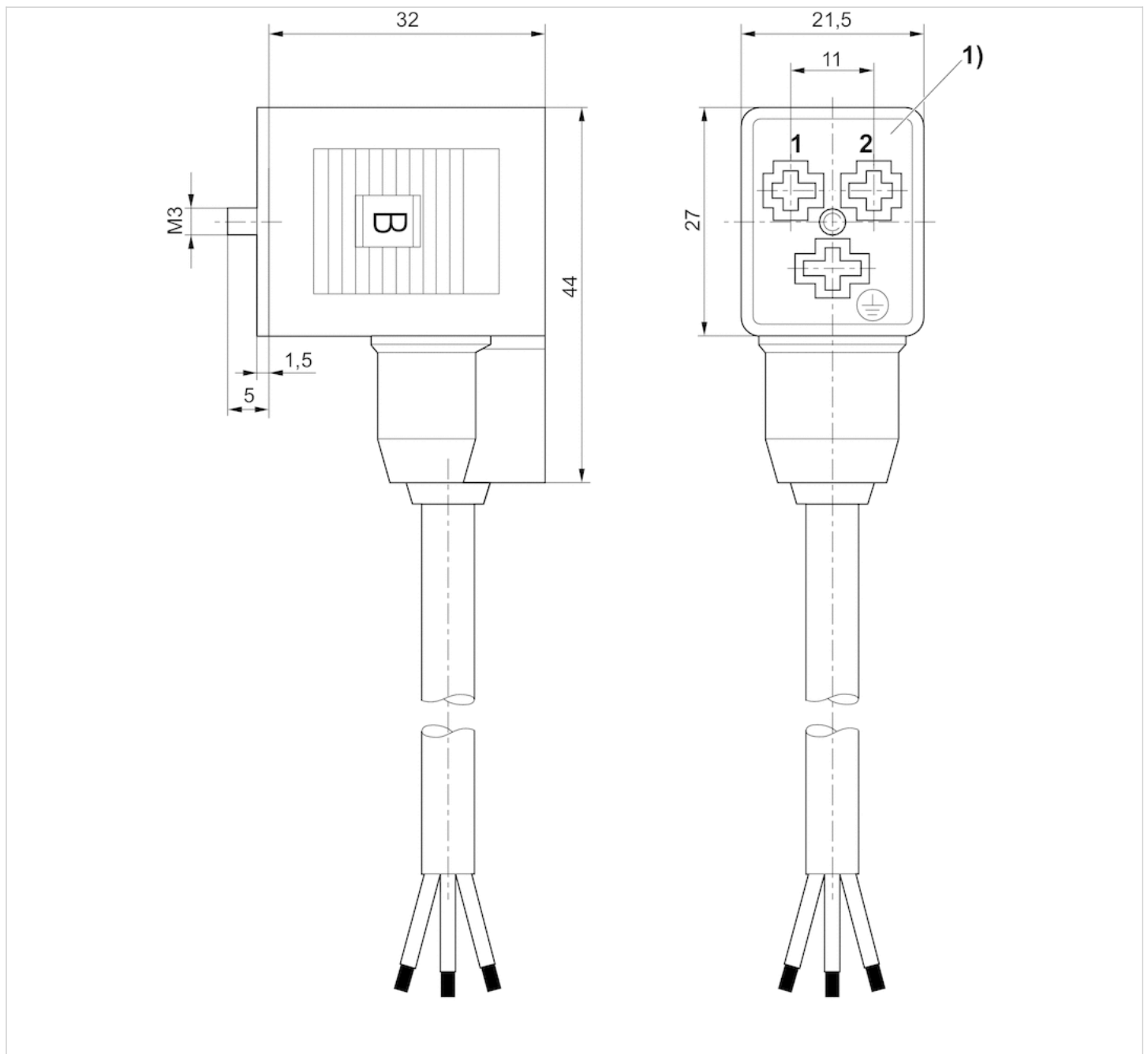

1) 0° female insert



# Valve plug connector, series CON-VP

- Socket, form C, 2+E, angled, 90°
- ISO 15217
- unshielded
- with LED Green

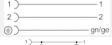

Connection type	Screws
Ambient temperature min./max.	-40 ... 90 °C
Operational voltage	See table below
Protection class	IP65
Mounting screw tightening torque	0,4 Nm
Weight	See table below

## Technical data

Part No.		Operational voltage	Max. current	Protective circuit	Contact assignment
1834484187		250 / 300 V AC/DC	6 A	-	2+E
8941012202		250 / 300 V AC/DC	6 A	-	2+E
4402050330		24 V AC/DC	-	Z-diode	2+E

Part No.	LED status display	suitable cable-Ø min./max	Seal	Weight
1834484187	-	4 / 8 mm	caoutchouc/butadiene caoutchouc	0,012 kg
8941012202	-	4 / 8 mm	-	0,012 kg
4402050330	Green	-	-	0,014 kg

Part No.	Fig.	
1834484187	Fig. 1	-
8941012202	Fig. 2	-
4402050330	Fig. 3	1)

1)

## Technical information

The specified protection class is only valid in assembled and tested state.

## Technical information

Material

Seals

caoutchouc/butadiene caoutchouc

## Dimensions

Fig. 1

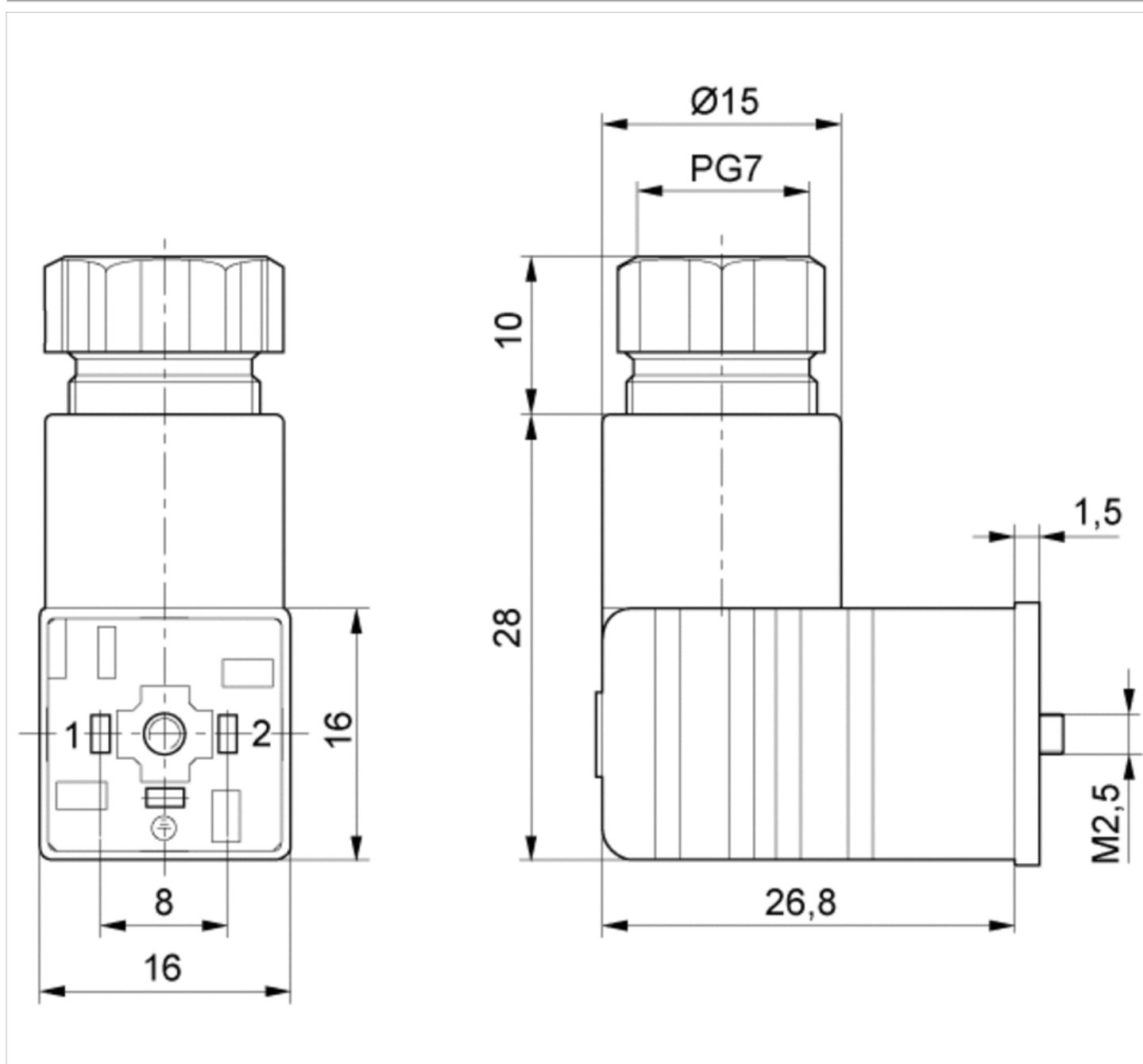

Fig. 2

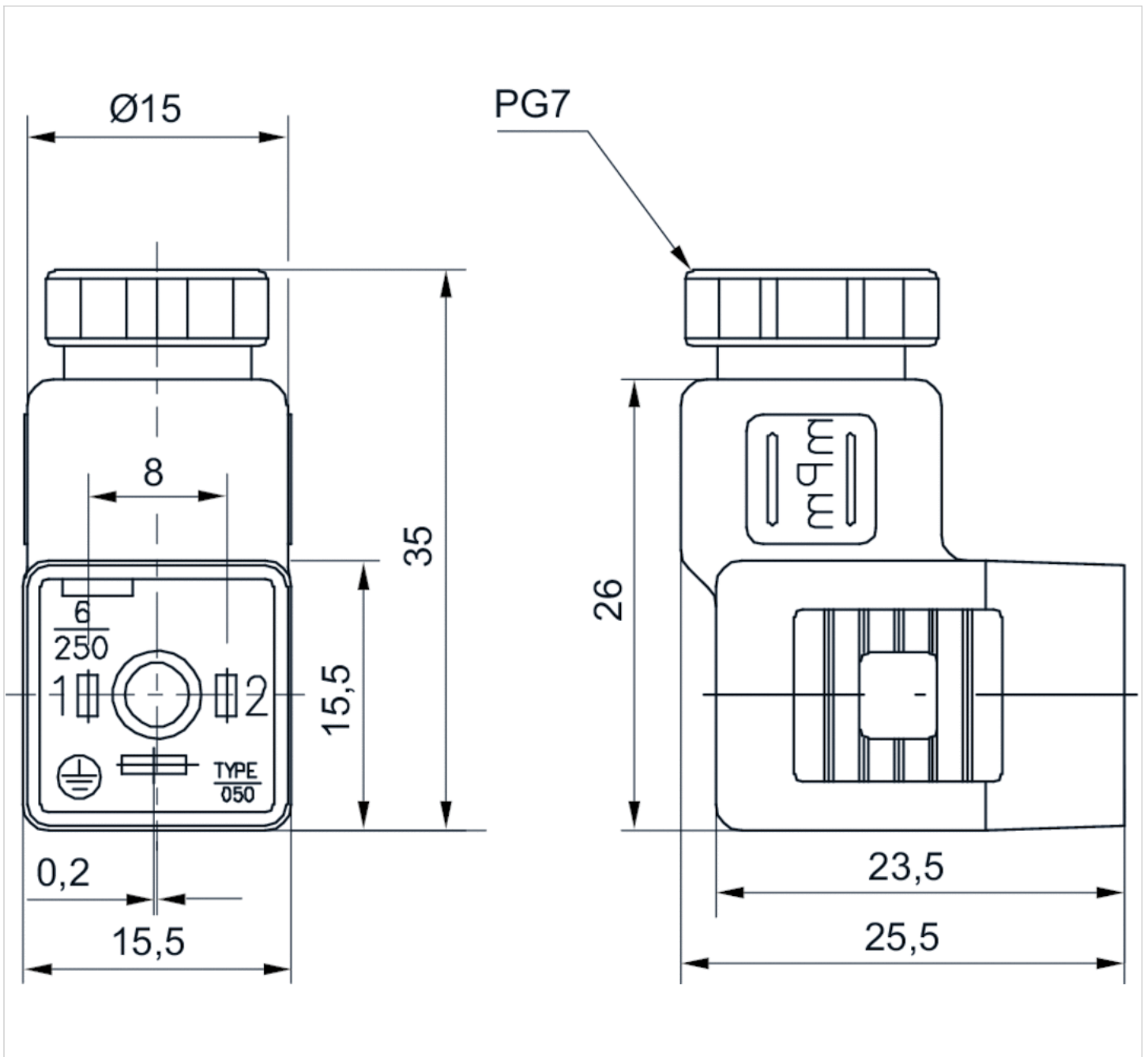
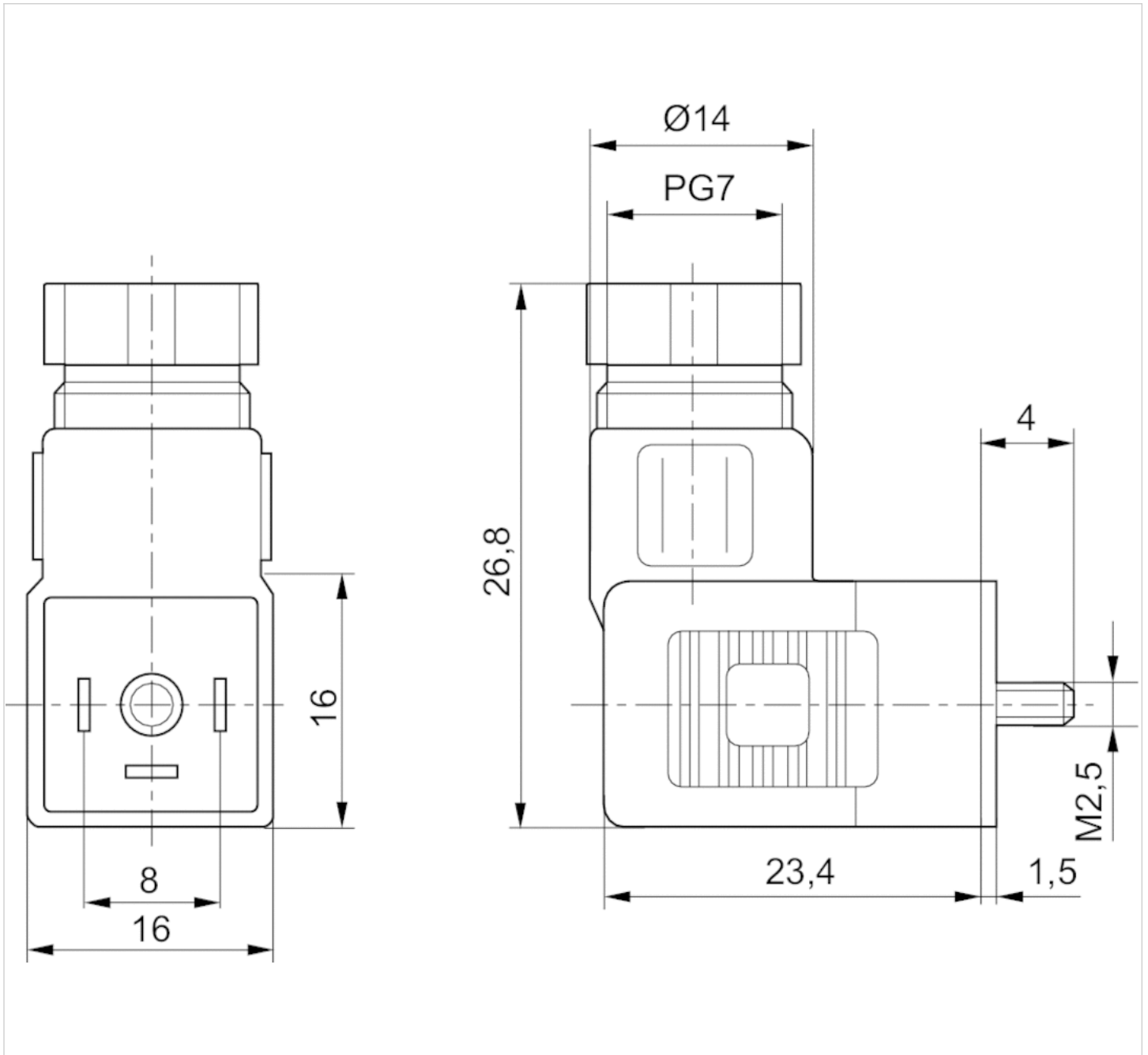
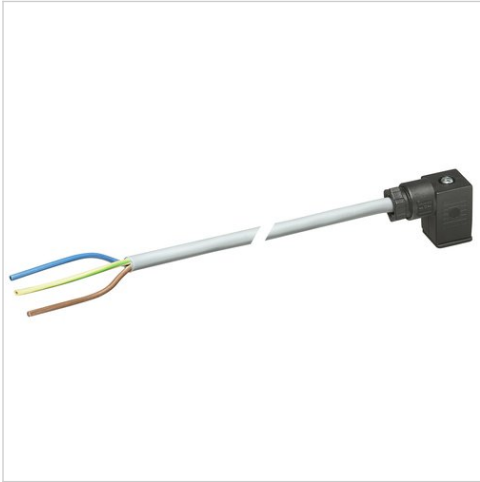

Fig. 3













# Valve plug connector, series CON-VP

- Socket form C 2+E angled 90°
- open cable ends 3-pin
- with cable
- unshielded

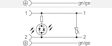
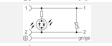

Ambient temperature min./max.	-20 ... 80 °C
Operational voltage	See table below
Protection class	IP67
Wire cross-section	0,75 mm <sup>2</sup>
Mounting screw tightening torque	0,4 Nm
Weight	See table below

## Technical data

Part No.		Operational voltage	Max. current	Protective circuit	Contact assignment
1834484212		230 V AC/DC	6 A	-	2+E
1834484213		230 V AC/DC	6 A	-	2+E
1834484214		230 V AC/DC	6 A	-	2+E
1834484215		230 V AC/DC	6 A	-	2+E
1834484204		24 V AC/DC	6 A	Z-diode	2+E
1834484205		24 V AC/DC	6 A	Z-diode	2+E
1834484206		24 V AC/DC	6 A	Z-diode	2+E
1834484207		24 V AC/DC	6 A	Z-diode	2+E
1834484208		230 V AC/DC	6 A	Varistor	2+E
1834484209		230 V AC/DC	6 A	Varistor	2+E
1834484210		230 V AC/DC	6 A	Varistor	2+E
1834484211		230 V AC/DC	6 A	Varistor	2+E
1834484236		24 V AC/DC	6 A	Z-diode	2+E

Part No.	LED status display	Number of wires	Cable-Ø	Cable length	Weight	Fig.	
1834484212	-	3	5,9 mm	3 m	0,183 kg	Fig. 1	-
1834484213	-	3	5,9 mm	3 m	0,183 kg	Fig. 2	-
1834484214	-	3	5,9 mm	5 m	0,308 kg	Fig. 1	-
1834484215	-	3	5,9 mm	5 m	0,308 kg	Fig. 2	-
1834484204	Yellow	3	5,9 mm	3 m	0,185 kg	Fig. 1	1)
1834484205	Yellow	3	5,9 mm	3 m	0,185 kg	Fig. 2	1)
1834484206	Yellow	3	5,9 mm	5 m	0,292 kg	Fig. 1	1)
1834484207	Yellow	3	5,9 mm	5 m	0,298 kg	Fig. 2	1)
1834484208	Yellow	3	5,9 mm	3 m	0,171 kg	Fig. 1	1)
1834484209	Yellow	3	5,9 mm	3 m	0,194 kg	Fig. 2	1)
1834484210	Yellow	3	5,9 mm	5 m	0,297 kg	Fig. 1	1)

Part No.	LED status display	Number of wires	Cable-Ø	Cable length	Weight	Fig.	
1834484211	Yellow	3	5,9 mm	5 m	0,285 kg	Fig. 2	1)
1834484236	Yellow	3	5,9 mm	10 m	0,571 kg	Fig. 2	1)

1) Scope of delivery incl. flat gasket

## Technical information

The specified protection class is only valid in assembled and tested state.

## Technical information

Material	
Seals	caoutchouc/butadiene caoutchouc
Cable sheath	Polyvinyl chloride



## Dimensions

Fig. 1, Dimensions in mm, 0° female insert

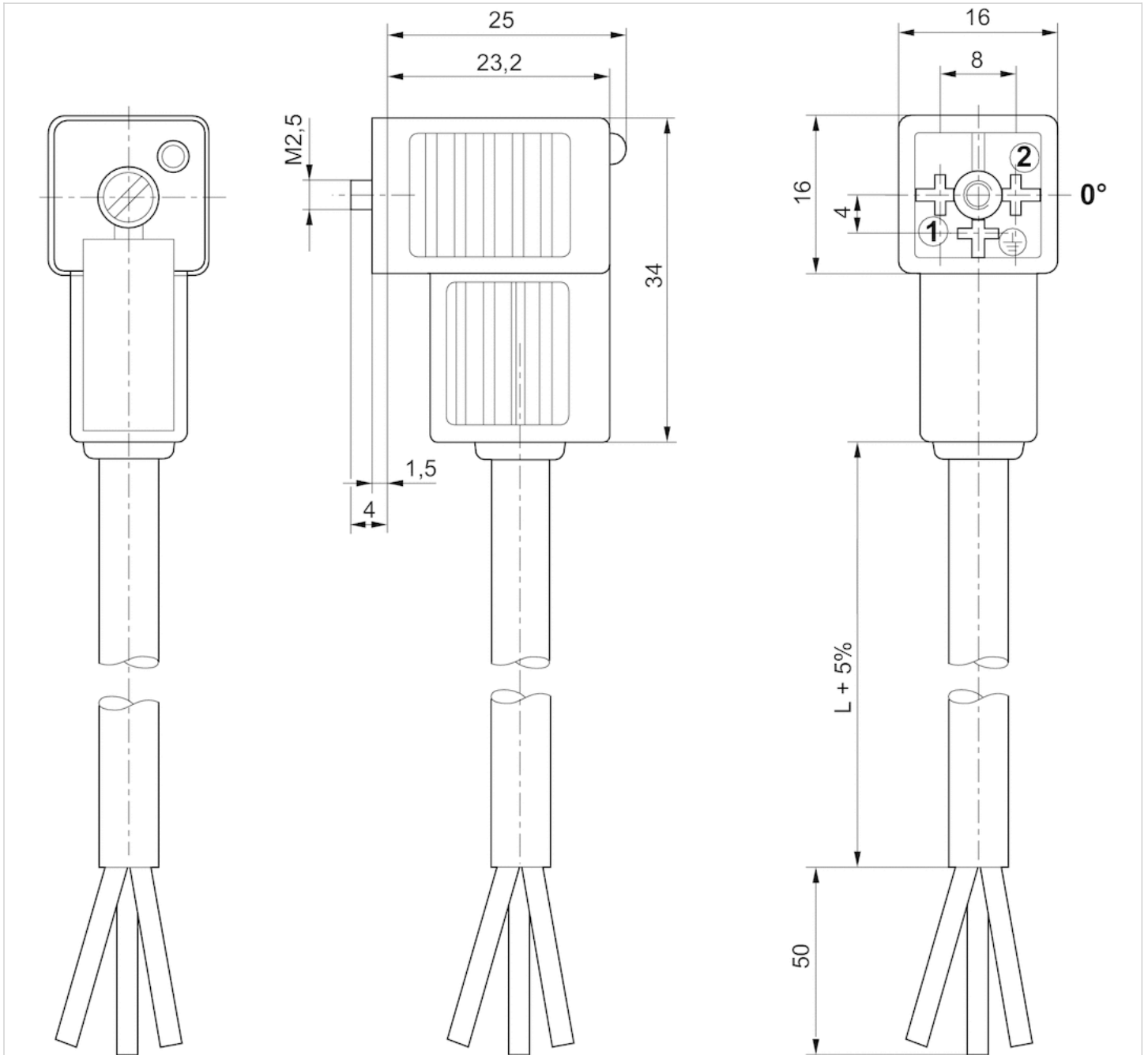
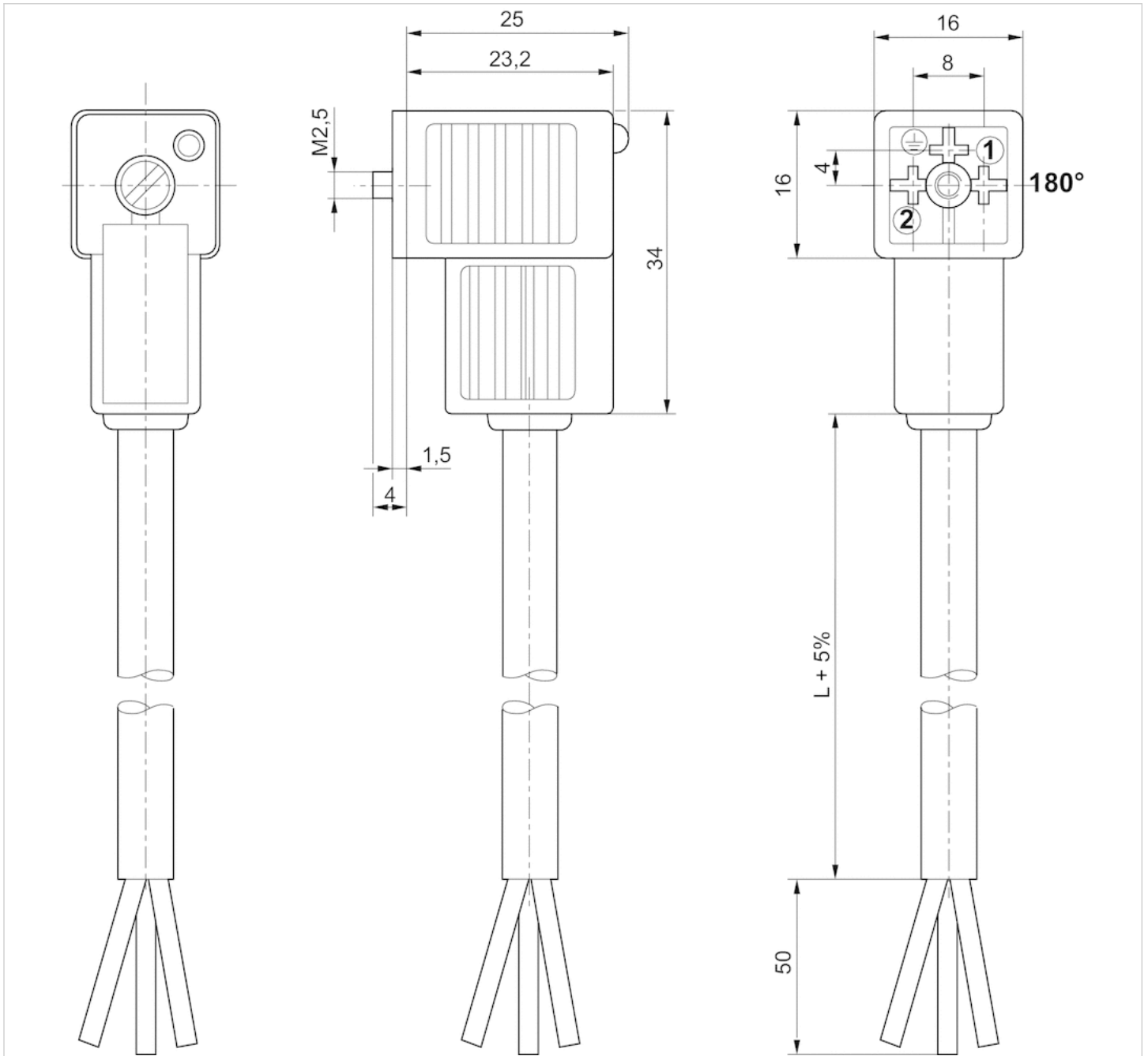

Fig. 2, Dimensions in mm, 180° female insert



# Adapter, Series CON-AP

- open cable ends 10 x snap Ø8 14-pin
- Socket M8x1 straight 180°
- with cable
- unshielded



Ambient temperature min./max.	-40 ... 90 °C
Operational voltage	48 V AC/DC
Protection class	IP67
Wire cross-section	0,34 mm <sup>2</sup>
Weight	See table below

## Technical data

Part No.	Max. current	Number of wires	Cable-Ø	Cable length	Weight
0493831909	2,1 A	14	8,6 mm	3 m	0,39 kg
0493832018	2,1 A	14	8,6 mm	10 m	1,167 kg

## Technical information

Material	
Housing	Polyurethane Polyamide
Cable sheath	Polyvinyl chloride

## Dimensions

### Dimensions

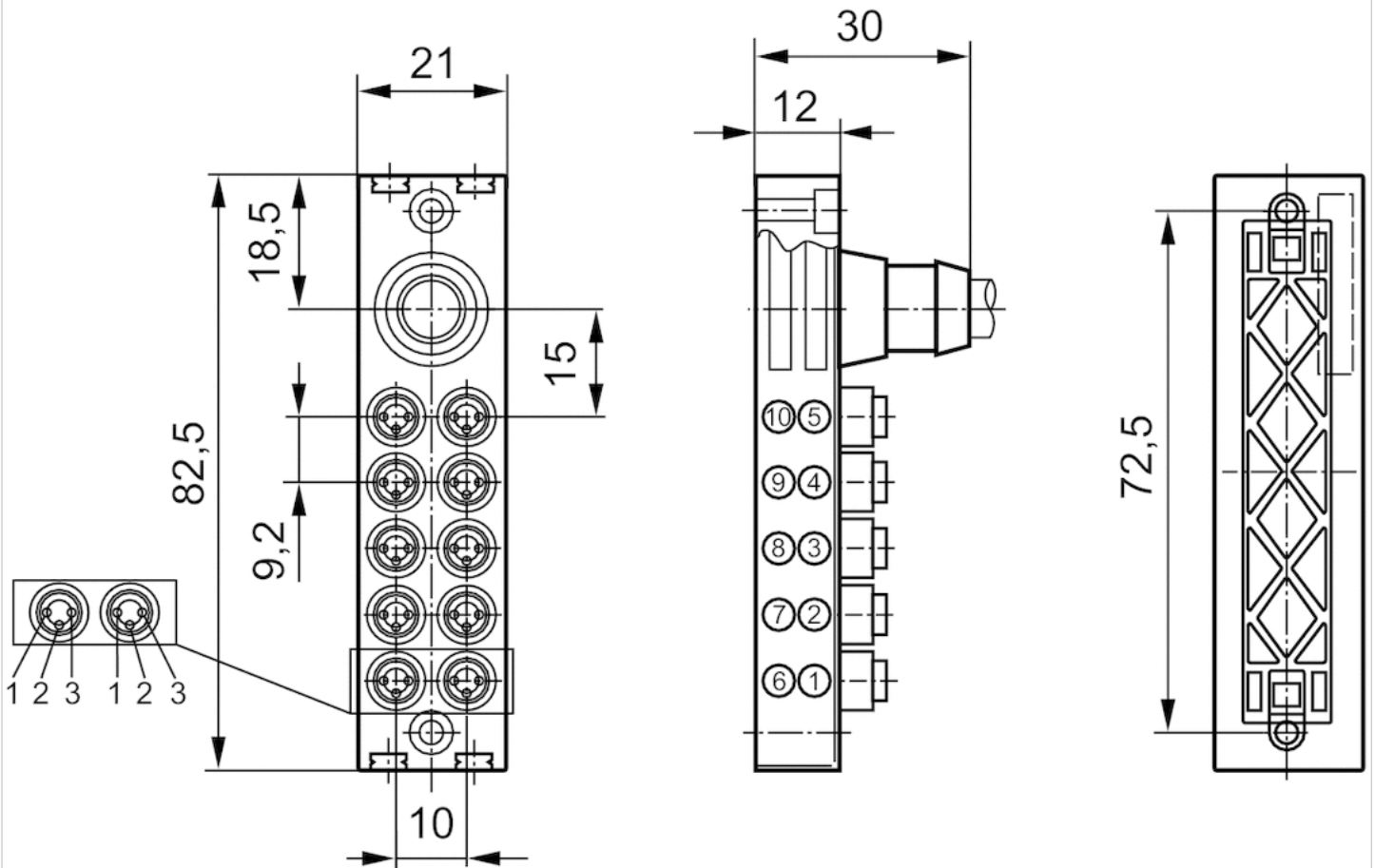

#### Pin assignment

- 1) +24 V
- 2) ground
- 3) 0 V

# Valve cover seal, Valve housing seal

- for 581

- size 1



Weight

See table below

## Technical data

Part No.	Type	Weight
0490429808	Valve cover seal, electrically operated valves	0,005 kg
0490429905	Valve cover seal, pneumatically operated valves	0,005 kg
0486715103	Valve housing seal, between housing and base plate	0,001 kg

## Technical information

Material	
Housing	Nitrile rubber

# valve cover, with or without pilot valve

- for 581
- size 1
- standard ISO 5599-1

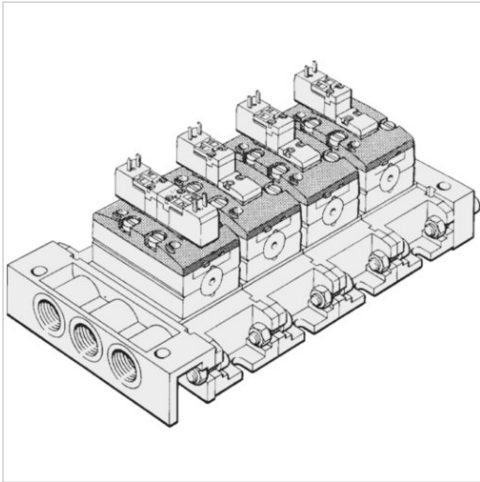

standard	ISO 5599-1
Ambient temperature min./max.	-20 ... 70 °C
Medium	Compressed air
Max. particle size	50 µm
Oil content of compressed air	40 ... 400 mg/m <sup>3</sup>
Weight	See table below

## Technical data

Part No.	Type	Pilot valve width	Weight	
0493842501	5/2-directional valve, single solenoid	15 mm	0,057 kg	1)
0493842609	2x3/2-, 5/2-, 5/3-directional valve	15 mm	0,054 kg	2)
5811010000	5/2-directional valve, mono-stable	22 mm	0,13 kg	3)
5811020000	2x3/2-, 5/2-, 5/3-directional valve	22 mm	0,15 kg	4)
5811050000	5/2-directional valve, mono-stable	22 mm	0,13 kg	5)
5811060000	2x3/2-, 5/2-, 5/3-directional valve	22 mm	0,15 kg	5)
5811080000	all	30 mm	0,2 kg	1)

- 1) without pilot valve
- 2) without pilot valve, For version 12 V DC - 230 V AC, 5 W
- 3) with pilot valve without coil, For version 12 V DC - 230 V AC, 5 W
- 4) with pilot valve without coil
- 5) with pilot valve without coil, For version 24 V DC, 2 W

# valve housing, without cover

- Aluminum
- for 581
- size 1
- standard ISO 5599-1

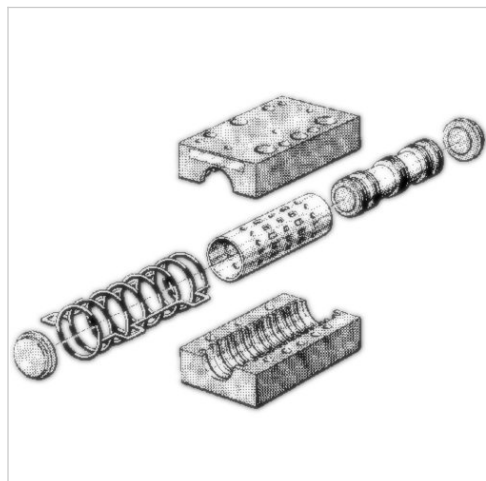

standard	ISO 5599-1
Ambient temperature min./max.	-20 ... 70 °C
Medium	Compressed air
Max. particle size	50 µm
Oil content of compressed air	40 ... 400 mg/m <sup>3</sup>
Weight	See table below

## Technical data

Part No.	Type	Weight
5811100000	5/2-directional valve, mono-stable	0,27 kg
5811200000	5/2-directional valve, double solenoid	0,27 kg
5811300000	5/2-directional valve, double solenoid, with manual override	0,27 kg
5811400000	5/3-directional valve, closed center	0,15 kg
5811500000	5/3-directional valve, exhausted center	0,2 kg
5811600000	5/2-way solenoid valve, with differential piston	0,2 kg
5811700000	5/3-directional valve, pressurized center	0,14 kg

The valve can be changed to a single solenoid version with air return., signal 14 has priority

## Technical information

Material	
Housing	Aluminum

# valve housing, without cover

- Plastic
- for 581
- size 1
- standard ISO 5599-1

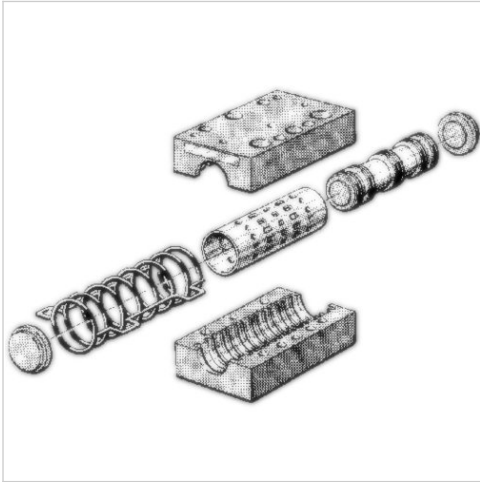

standard	ISO 5599-1
Ambient temperature min./max.	-20 ... 70 °C
Medium	Compressed air
Max. particle size	50 µm
Oil content of compressed air	40 ... 400 mg/m <sup>3</sup>
Weight	See table below

## Technical data

Part No.	Type	Weight
R402002299	2x3/2-way solenoid valve	0,1 kg
R402002292	5/2-directional valve, mono-stable	0,09 kg
R402002293	5/2-directional valve, double solenoid	0,08 kg
R402002294	5/2-directional valve, double solenoid, with manual override	0,08 kg
R402002297	5/2-way solenoid valve, with differential piston	0,14 kg
R402002295	5/3-directional valve, closed center	0,09 kg
R402002298	5/3-directional valve, pressurized center	0,09 kg
R402002296	5/3-directional valve, exhausted center	0,09 kg

The valve can be changed to a single solenoid version with air return., signal 14 has priority

## Technical information

Material	
Housing	Polyamide fiber-glass reinforced



# Safety plugs for throttle insert

- Archive product: Do not use in new constructions!

- for 581

- size 1 - 4

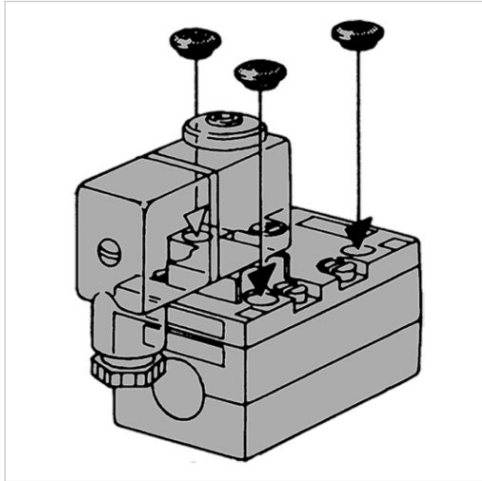

Weight

0,005 kg

## Technical data

Part No.

4634210000

# Throttle plate

- Archive product: Do not use in new constructions!
- standard ISO 5599-1
- Frame size ISO 3



Standards	ISO 5599-1
Working pressure min./max.	0 ... 16 bar
Ambient temperature min./max.	0 ... 80 °C
Medium temperature min./max.	0 ... 80 °C
Medium	Compressed air
Weight	1.01 kg

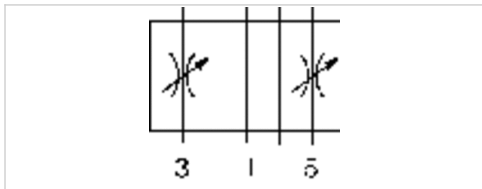

## Technical data

Part No.
0821201025

Scope of delivery incl. seal and mounting screws

## Technical information

The min. control pressure must be adhered to, since otherwise faulty switching and valve failure may result!  
 The pressure dew point must be at least 15 °C under ambient and medium temperature and may not exceed 3 °C .  
 The oil content of compressed air must remain constant during the life cycle.  
 Use only the approved oils from AVENTICS. Further information can be found in the "Technical information" document (available in the MediaCentre).

## Technical information

Material	
Base plate	Aluminum
Seal	Acrylonitrile butadiene rubber

## Dimensions

### Dimensions

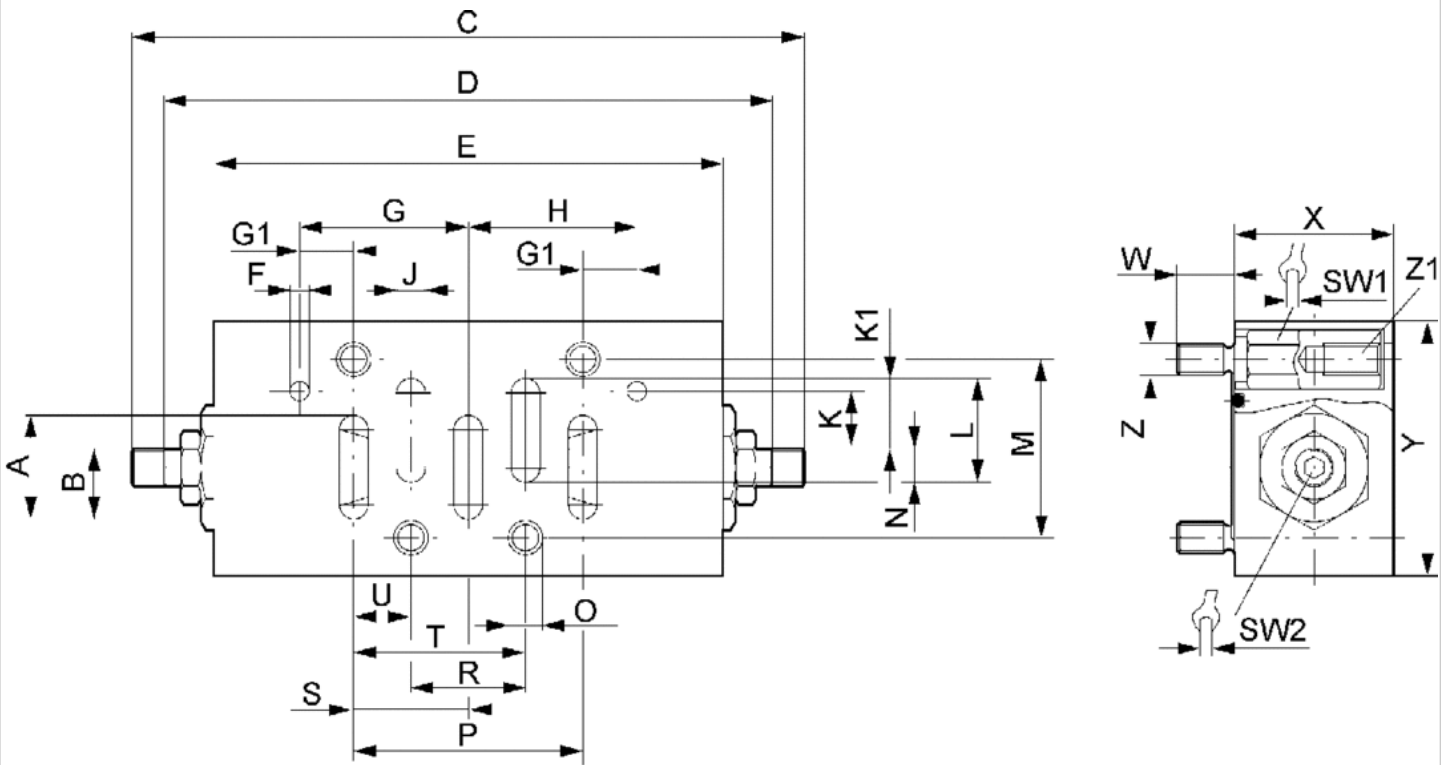

## Dimensions

Part No.	A	B	C	D	E	F	G	G1	H	J	K	K1	L	M	N	O	P	R	S	SW1	SW2	T
0821201025	29	16,5	189.9	169.9	140	4	45	13	45	10	11.5	16.5	29	48	12.5	8.2	64	32	32	11	4	48

U	W	X	Y	Z	Weight	Z1
16	14	35	70	M8	1.01 kg	M8-14

# Efficient pneumatic solutions, our program: cylinders and drives, valves and valve systems, air supply management



Visit us: [Emerson.com/Aventics](https://www.emerson.com/Aventics)

Your local contact: [Emerson.com/contactus](https://www.emerson.com/contactus)



Emerson.com



[Facebook.com/EmersonAutomationSolutions](https://www.facebook.com/EmersonAutomationSolutions)



[LinkedIn.com/company/Emerson-Automation-Solutions](https://www.linkedin.com/company/Emerson-Automation-Solutions)



[Twitter.com/EMR\\_Automation](https://twitter.com/EMR_Automation)

An example configuration is depicted on the title page. The delivered product may thus vary from that in the illustration. Subject to change. This Document, as well as the data, specifications and other information set forth in it, are the exclusive property of AVENTICS GmbH. It may not be reproduced or given to third parties without its consent. Only use the AVENTICS products shown in industrial applications. Read the product documentation completely and carefully before using the product. Observe the applicable regulations and laws of the respective country. When integrating the product into applications, note the system manufacturer's specifications for safe use of the product. The data specified only serve to describe the product. No statements concerning a certain condition or suitability for a certain application can be derived from our information. The information given does not release the user from the obligation of own judgement and verification. It must be remembered that the products are subject to a natural process of wear and aging.

The Emerson logo is a trademark and service mark of Emerson Electric Co. Brand logotype are registered trademarks of one of the Emerson family of companies. All other marks are the property of their respective owners. © 2021 Emerson Electric Co. All rights reserved.  
2021-07



## CONSIDER IT SOLVED™