

# Clean One-touch Fittings and Tubing

## Series *KP/KPQ/KPG*

## Series *TPH/TPS*

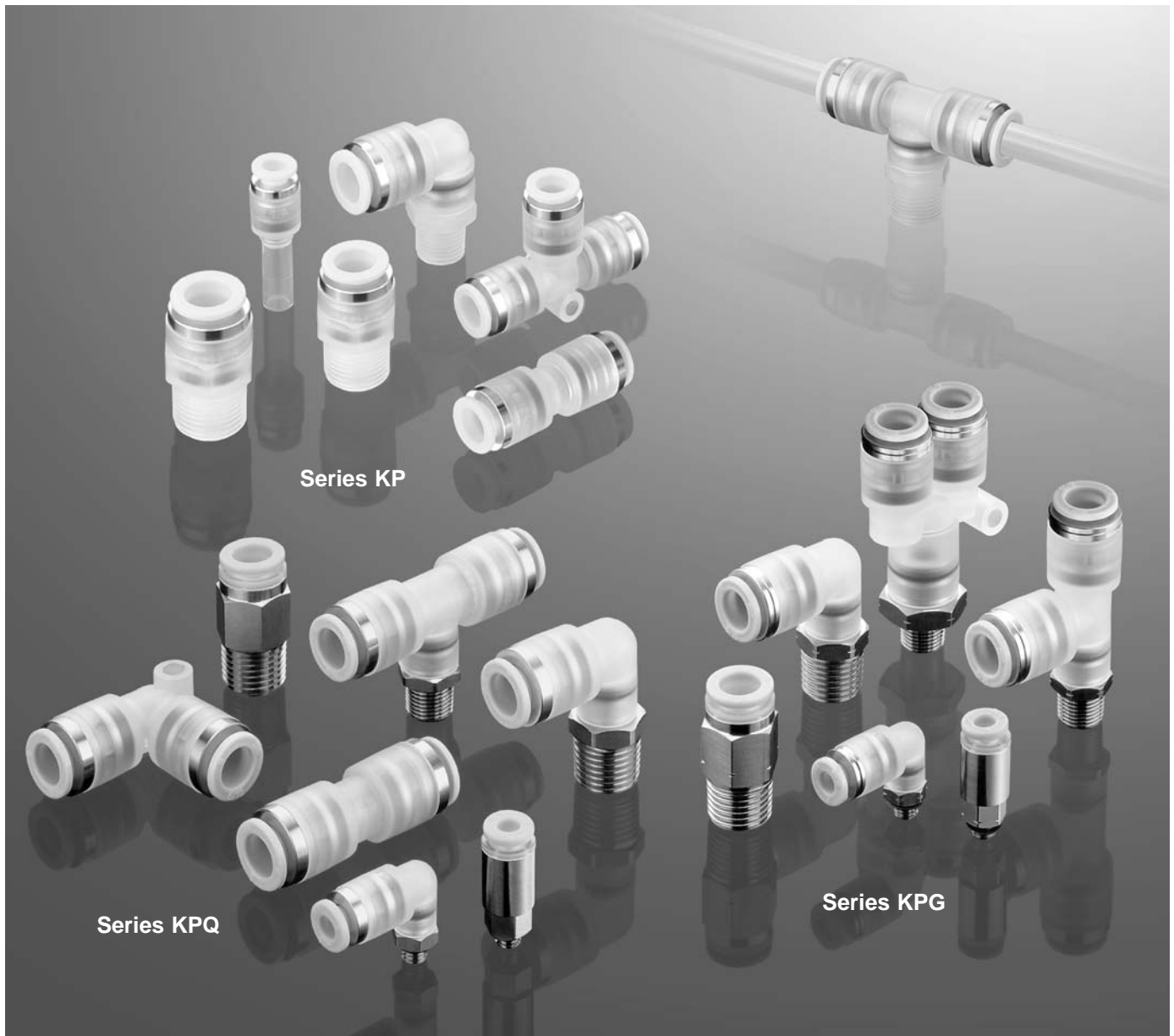

Series KPQ/KPG for drive system air piping added to clean One-touch fitting series KP

K□

M□

H□

D□

MS

T□

LQ

Clean Room

# One-touch fittings and tubing for clean room blowing systems



One-touch fittings (for blowing)

## Series KP

- Completely oil free
- Liquid-contact areas are non-metallic
- Parts cleaning, assembly and double packaging in a clean room
- Can be used for vacuum (-100kPa)

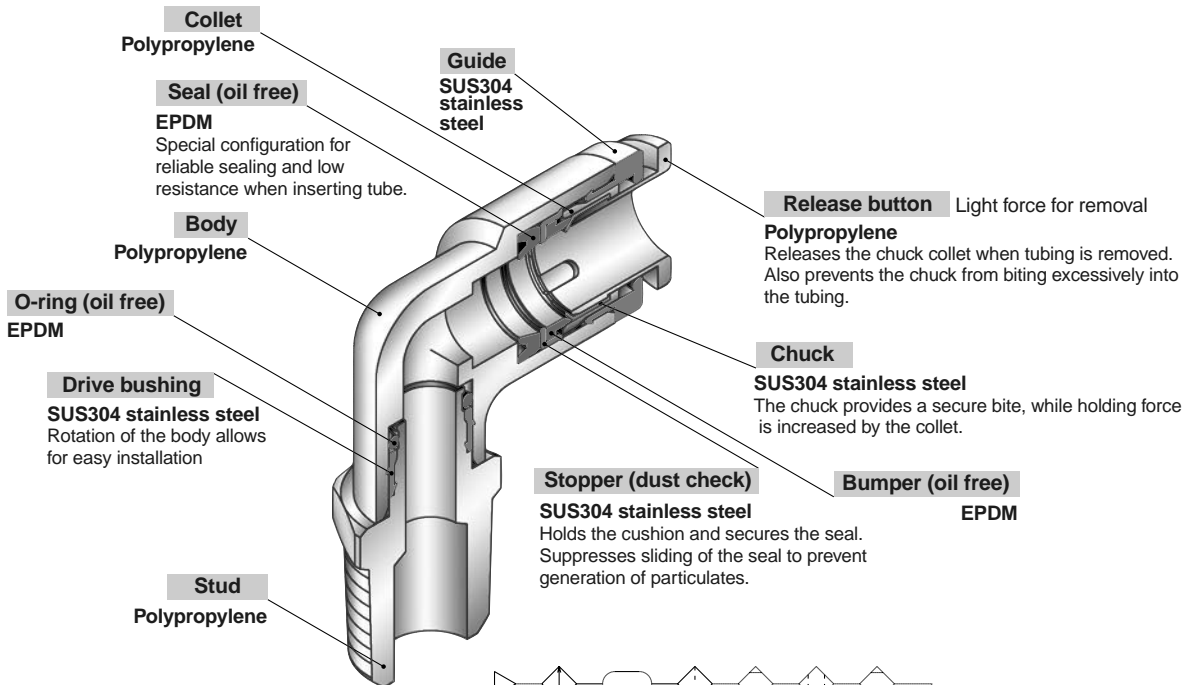

### ■ Clean blowing system

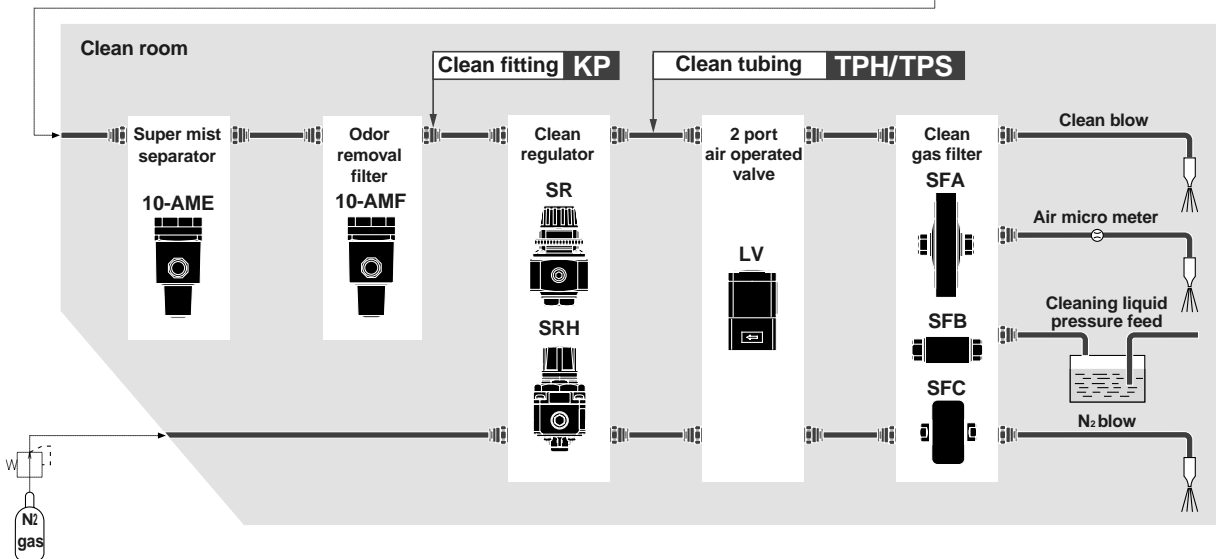

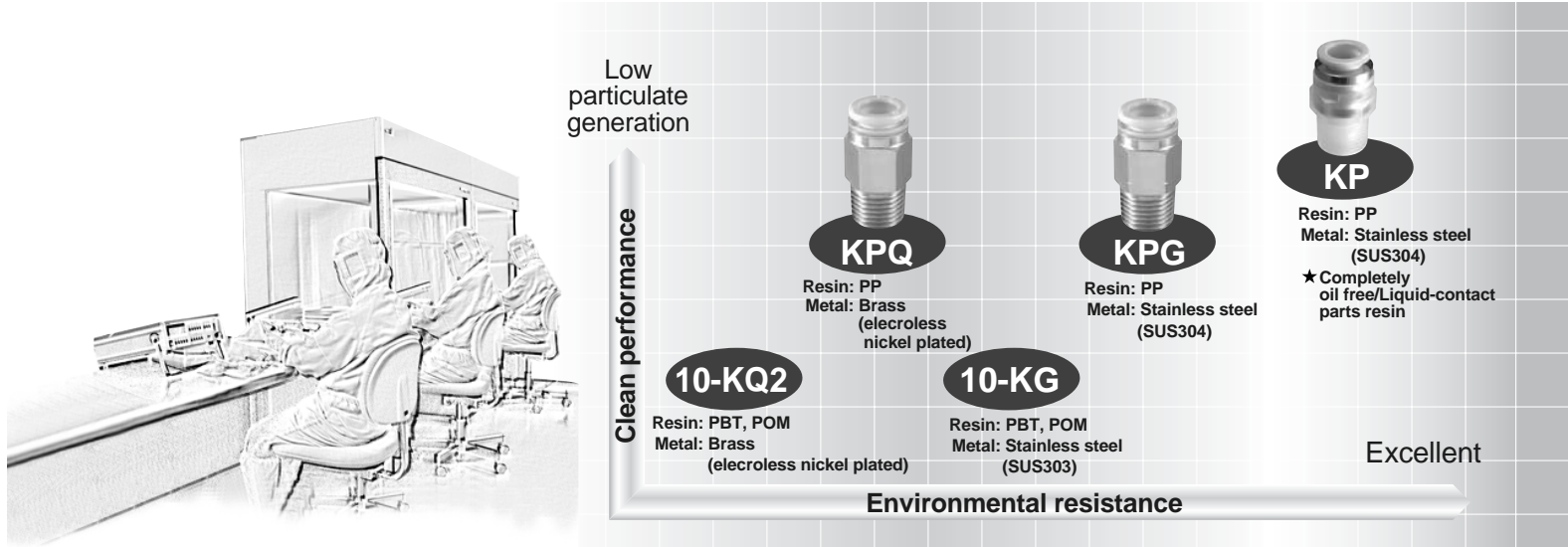

One-touch fittings (for drive system air piping)

# Series KPQ/KPG

Brass  
(electroless nickel plated)

Stainless steel  
(SUS304)

- M5 size standardized
- Resin parts are P.P. (polypropylene)



Series KPQ

Series KPG

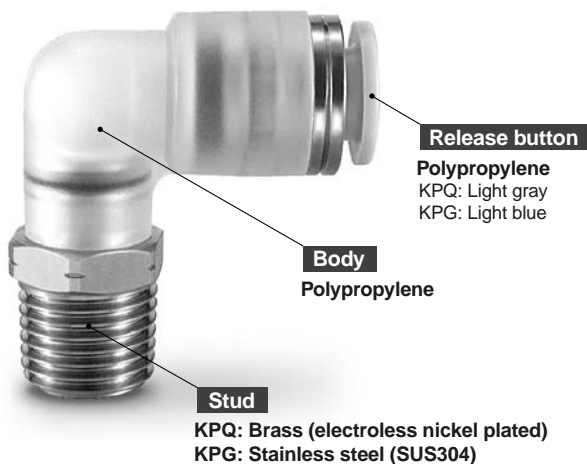

Male connector

## Drive air piping system

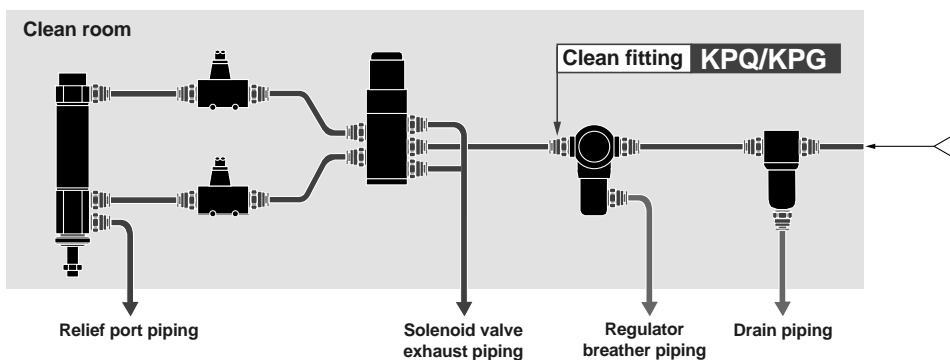

## Polyolefin Tubing Series TPH/TPS



Series	Material	Tubing O.D. mm					Colour	Tubing length m
		4	6	8	10	12		
TPH	Polyolefin	●	●	●	●	●	White, Black Red, Blue	20
TPS	Soft Polyolefin	●	●	●	●	●	Yellow, Green	100

K□

M□

H□

D□

MS

T□

LQ

Clean Room

# For Blowing Series *KP*



## ⚠ Caution

Series KP is a line of special One-touch fittings for use in clean room blowing and washing lines. Consult SMC regarding other types of applications.

Seal material: The durability of EPDM with respect to mineral oils is inferior, which makes it unsuitable for piping in general pneumatic equipment.

## Recommended Applicable Tubing

<b>Tubing material</b>	Polyolefin: Series TPH Soft polyolefin: Series TPS
<b>Tubing O.D.</b>	ø4, ø6, ø8, ø10, ø12

Note 1) Polyurethane tubing: Series TU, Nylon tubing: Series T, and Soft nylon tubing: Series TS can also be used. However, the degree of clean performance will be reduced.

Note 2) Due to the softness of polyurethane tubing, it may fold when being inserted. Hold the end of the tubing and insert it all the way in.

## Specifications

<b>Particulate generation grade</b>	Grade 1 <sup>Note 1)</sup>
<b>Fluid</b>	Air, Nitrogen gas, Water (pure water) <sup>Note 2)</sup>
<b>Maximum operating pressure (20°C)</b>	1MPa <sup>Note 3)</sup>
<b>Operating vacuum pressure</b>	-100kPa
<b>Proof pressure (20°C)</b>	3MPa
<b>Ambient and fluid temperature</b>	-20°C to 80°C
<b>Threads</b>	JIS B0203 (taper threads for piping)

Note 1) Refer to particulate generation grade classifications.

Note 2) Consult SMC regarding other fluids.

Note 3) The maximum operating pressure is the value at 20°C. Refer to the operating pressure curve for other temperatures.

## Principal Part Materials

<b>Body</b>	Polypropylene resin
<b>Stud</b>	Polypropylene resin
<b>Chuck</b>	SUS304 stainless steel
<b>Guide, Stopper, Drive bushing</b>	SUS304 stainless steel
<b>Collet, Release button</b>	Polypropylene resin
<b>Seal, O-ring, Bumper</b>	EPDM

## Particulate Generation Grade Classifications

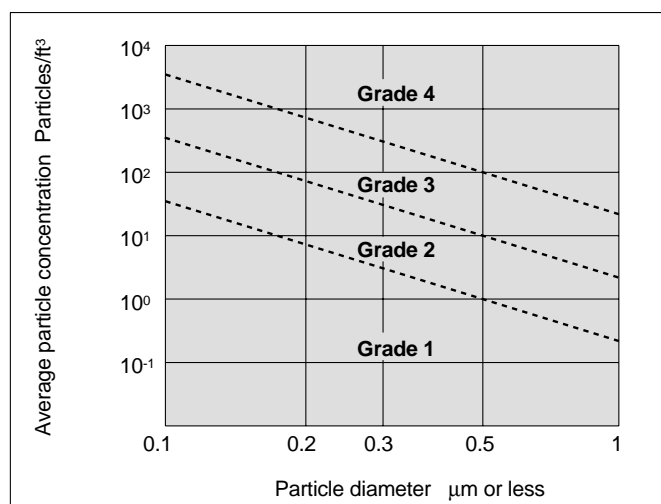

## Relationship of Operating Temperature and Maximum Operating Pressure

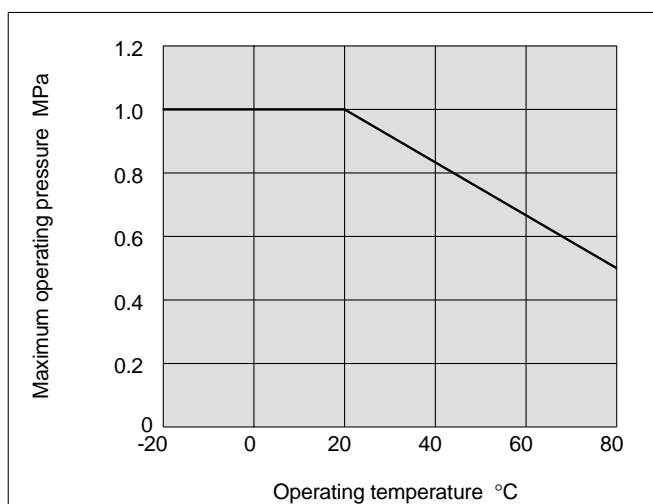

## How to Order

**KP H 06 01**

Clean One-touch fitting (for blowing)

Model

H	Male connector, Straight union
L	Union elbow, Male elbow
T	Male branch tee, Union tee
Y	Male run tee
U	Male branch, Union "Y"
R	Plug-in reducer

Port size/Applicable tubing O.D.

Thread connection	01	R 1/8
	02	R 1/4
	03	R 3/8
	04	R 1/2
Tubing (rod) connection	00	Same dia. tubing
	04	ø4
	06	ø6
	08	ø8
	10	ø10
	12	ø12

Different dia. tubing (plug-in reducer)

Applicable tubing O.D.

04	ø4
06	ø6
08	ø8
10	ø10
12	ø12

**KP P 08**

Applicable fitting size

04	ø4
06	ø6
08	ø8
10	ø10
12	ø12

Plug

Clean One-touch fitting

## Construction

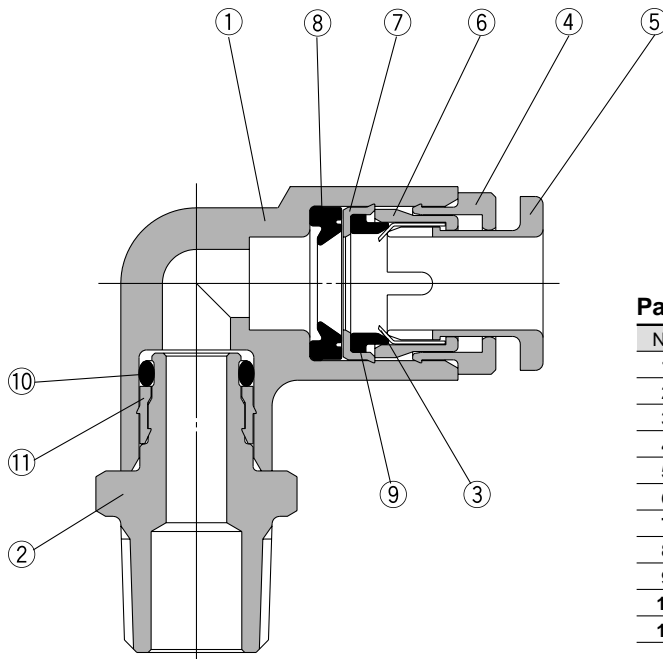

### Parts list

No.	Description	Material
1	Body	Polypropylene resin
2	Stud	Polypropylene resin
3	Chuck	SUS304 stainless steel
4	Guide	SUS304 stainless steel
5	Release button	Polypropylene resin (color: light green)
6	Collet	Polypropylene resin
7	Stopper	SUS304 stainless steel
8	Seal	EPDM
9	Bumper	EPDM
10	O-ring	EPDM
11	Drive bushing	SUS304 stainless steel

K

M

H

D

MS

T

LQ

Clean Room

# Series KP

## Dimensions

### Male Connector: KPH



Applicable tubing O.D. mm	Connection threads R	Model	H (width across flats)	L	A*	M	Effective area mm <sup>2</sup>		Weight g
							TPH	TPS	
4	1/8	KPH04-01	12	25.4	21.5	18	4	4	3
	1/4	KPH04-02	14	25.4	19.5				4
6	1/8	KPH06-01	14	25.9	22	19.5	10	10	4
	1/4	KPH06-02		26.4	20.5				5
8	1/8	KPH08-01	17	32.3	28.5	21.5	26	18	6
	1/4	KPH08-02		30.3	24.5				7
10	1/4	KPH10-02	19	37.5	32	24	41	29	10
	3/8	KPH10-03		33	27				11
12	3/8	KPH12-03	22	34	28	25	58	46	12
	1/2	KPH12-04		34.5	27				13

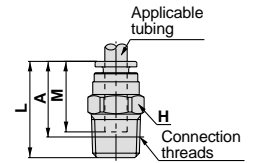

\* Reference dimension for R threads after installation

### Male Elbow: KPL



Applicable tubing O.D. mm	Connection threads R	Model	H (width across flats)	Note 1) $\phi D_1$	$\phi D_2$	L <sub>1</sub>	L <sub>2</sub>	A*	M	Effective area mm <sup>2</sup>		Weight g
										TPH	TPS	
4	1/8	KPL04-01	12	10.4	10	20.7	23.2	24.5	18	3.5	3.5	4
	1/4	KPL04-02	14									27.2
6	1/8	KPL06-01	12	12.8	10	22.8	24.4	27	19.5	9	9	5
	1/4	KPL06-02	14									28.4
8	1/8	KPL08-01	14	15.2	12	26.3	26.6	30	21.5	22	15	8
	1/4	KPL08-02	14									29.4
10	1/4	KPL10-02	17	18.5	17	29.4	32.1	35.5	24	35	25	13
	3/8	KPL10-03										33.1
12	3/8	KPL12-03	17	20.9	17	31.4	34.3	38.5	25	50	40	15
	1/2	KPL12-04										22

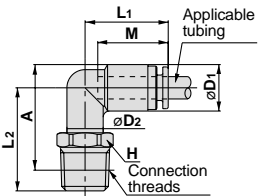

\* Reference dimension for R threads after installation Note 1)  $\phi D_1$  indicates the maximum diameter.

### Male Branch Tee: KPT



Applicable tubing O.D. mm	Connection threads R	Model	H (width across flats)	Note 1) $\phi D_1$	$\phi D_2$	L <sub>1</sub>	L <sub>2</sub>	A*	M	Effective area mm <sup>2</sup>		Weight g
										TPH	TPS	
4	1/8	KPT04-01	12	10.4	10	20.7	23.2	24.5	18	4.1	4.1	6
	1/4	KPT04-02	14									27.2
6	1/8	KPT06-01	12	12.8	10	22.8	24.4	27	19.5	11	11	8
	1/4	KPT06-02	14									28.4
8	1/8	KPT08-01	14	15.2	12	26.3	26.6	30	21.5	26.3	18.2	12
	1/4	KPT08-02	14									29.4
10	1/4	KPT10-02	17	18.5	17	29.4	32.1	35.5	24	40.8	29	20
	3/8	KPT10-03										33.1
12	3/8	KPT12-03	17	20.9	17	31.4	34.3	38.5	25	57.2	45.2	24
	1/2	KPT12-04										22

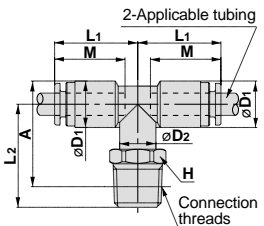

\* Reference dimension for R threads after installation Note 1)  $\phi D_1$  indicates the maximum diameter.

### Male Run Tee: KPY



Applicable tubing O.D. mm	Connection threads R	Model	H (width across flats)	Note 1) $\phi D_1$	$\phi D_2$	L <sub>1</sub>	L <sub>2</sub>	A*	M	Effective area mm <sup>2</sup>		Weight g
										TPH	TPS	
4	1/8	KPY04-01	12	10.4	10	20.7	23.2	40	18	7.5	7.5	6
	1/4	KPY04-02	14									27.2
6	1/8	KPY06-01	12	12.8	10	22.8	24.4	43	19.5	11	11	8
	1/4	KPY06-02	14									28.4
8	1/8	KPY08-01	14	15.2	12	26.3	26.6	49	21.5	21	21	12
	1/4	KPY08-02	14									29.4
10	1/4	KPY10-02	17	18.5	17	29.4	32.1	56	24	45	45	19
	3/8	KPY10-03										33.1
12	3/8	KPY12-03	17	20.9	17	31.4	34.3	59.5	25	57	57	21
	1/2	KPY12-04										22

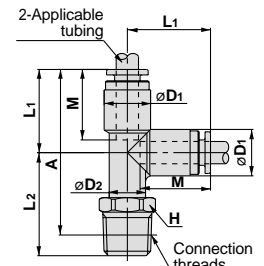

\* Reference dimension for R threads after installation Note 1)  $\phi D_1$  indicates the maximum diameter.

### Male Branch "Y": KPU



Applicable tubing O.D. mm	Connection threads R	Model	H (width across flats)	Note 1) $\phi D$	L	P	A*	M	Effective area mm <sup>2</sup>		Weight g
									TPH	TPS	
4	1/8	KPU04-01	12	10.4	45.4	10.4	41.5	18	7.5	7.5	7
	1/4	KPU04-02	14								49.4
6	1/8	KPU06-01	14	12.8	49.6	12.8	45.5	19.5	18	18	9
	1/4	KPU06-02	14								52.4
8	1/8	KPU08-01	17	15.2	56.7	15.2	52.5	21.5	26	26	15
	1/4	KPU08-02	17								61.3
10	1/4	KPU10-02	19	18.5	64.5	18.5	59	24	45	45	23
	3/8	KPU10-03									67.5
12	3/8	KPU12-03	22	20.9	69.7	20.9	63.5	25	70	70	29
	1/2	KPU12-04									72.7

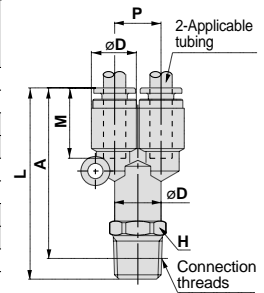

\* Reference dimension for R threads after installation Note 1)  $\phi D$  indicates the maximum diameter.



## Dimensions

### Straight Union: KPH



Applicable tubing O.D. mm	Model	Note 1) $\varnothing D$	L	M	Effective area mm <sup>2</sup>		Weight g
					TPH	TPS	
4	KPH04-00	10.4	37.4	18	4	4	4
6	KPH06-00	12.8	39.6	19.5	10	10	6
8	KPH08-00	15.2	44.4	21.5	26	18	10
10	KPH10-00	18.5	48.6	24	41	29	15
12	KPH12-00	20.9	50.6	25	58	46	18

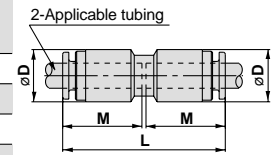

Note 1)  $\varnothing D$  indicates the maximum diameter.

### Union Elbow: KPL



Applicable tubing O.D. mm	Model	Note 1) $\varnothing D$	L	Q	M	Effective area mm <sup>2</sup>		Weight g
						TPH	TPS	
4	KPL04-00	10.4	20.7	4.5	18	3.5	3.5	3
6	KPL06-00	12.8	22.8	5.3	19.5	9	9	7
8	KPL08-00	15.2	26.3	6	21.5	22	15	11
10	KPL10-00	18.5	29.4	6.8	24	35	25	16
12	KPL12-00	20.9	31.4	7.5	25	50	40	20

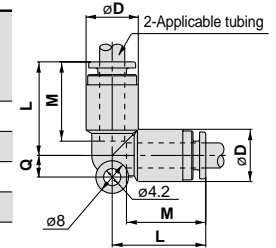

Note 1)  $\varnothing D$  indicates the maximum diameter.

### Union Tee: KPT



Applicable tubing O.D. mm	Model	Note 1) $\varnothing D$	L	Q	M	Effective area mm <sup>2</sup>		Weight g
						TPH	TPS	
4	KPT04-00	10.4	20.7	4.5	18	4	4	7
6	KPT06-00	12.8	22.8	5.3	19.5	10	10	9
8	KPT08-00	15.2	26.3	6	21.5	26	18	16
10	KPT10-00	18.5	29.4	6.8	24	41	29	25
12	KPT12-00	20.9	31.4	7.5	25	58	46	29

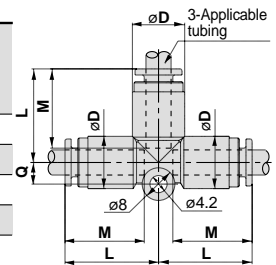

Note 1)  $\varnothing D$  indicates the maximum diameter.

### Union "Y": KPU



Applicable tubing O.D. mm	Model	Note 1) $\varnothing D$	L <sub>1</sub>	L <sub>2</sub>	P	Q	M	Effective area mm <sup>2</sup>		Weight g
								TPH	TPS	
4	KPU04-00	10.4	38.8	20.6	10.4	9.7	18	4	4	7
6	KPU06-00	12.8	42.1	22.8	12.8	11.7	19.5	10	10	10
8	KPU08-00	15.2	48.7	27.5	15.2	13.7	21.5	26	18	17
10	KPU10-00	18.5	54	30.7	18.5	16.1	24	41	29	26
12	KPU12-00	20.9	57.2	32.9	20.9	18.1	25	58	46	32

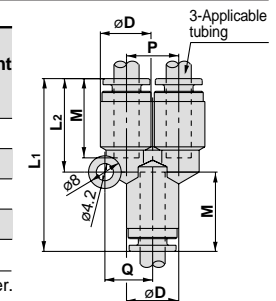

Note 1)  $\varnothing D$  indicates the maximum diameter.

### Plug-in Reducer: KPR



Applicable tubing O.D. mm	Applicable fitting size $\varnothing d$	Model	Note 1) $\varnothing D$	L	A	M	Effective area mm <sup>2</sup>		Weight g
							TPH	TPS	
4	6	KPR04-06	10.4	39.4	20.1	18	4	4	3
	8	KPR04-08		41.9	20.2				4
6	8	KPR06-08	12.8	42.5	20.8	19.5	10	10	4
		KPR06-10		45	21.2				5
8	10	KPR08-10	15.2	47	23.2	21.5	26	18	5
	12	KPR08-12		48	23.2				6
10	12	KPR10-12	18.5	50.5	25.7	24	41	29	9

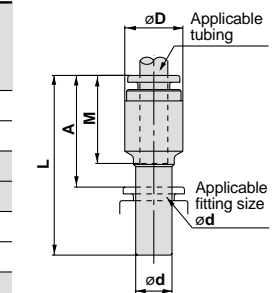

Note 1)  $\varnothing D$  indicates the maximum diameter.

### Plug: KPP



Applicable fitting size $\varnothing d$	Model	$\varnothing D$	L	A	Weight g
4	KPP-04	6	32	13.8	0.4
6	KPP-06	8	35	15.7	0.7
8	KPP-08	10	39	17.3	1.1
10	KPP-10	12	43	19.2	1.7
12	KPP-12	14	45.5	20.7	2.5

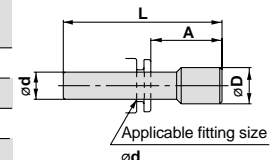

K

M

H

D

MS

T

LQ

Clean Room

Clean  
One-touch  
Fittings

# For Drive System Air Piping

# Series *KPQ/KPG*



**Series KPQ**  
Brass (electroless nickel plated)  
Release button: Light gray



**Series KPG**  
Stainless steel (SUS304)  
Release button: Light blue

## Recommended Applicable Tubing

<b>Tubing material</b>	Polyurethane: 10-series
<b>Tubing O.D.</b>	ø4, ø6, ø8, ø10, ø12

Polyurethane tubing: Series TU, Nylon tubing: Series T, and Soft nylon tubing: Series TS can also be used. However, the degree of clean performance will be reduced.

## Specifications

<b>Particulate generation grade</b>	Grade 1 Note 1)
<b>Fluid</b>	Air
<b>Maximum operating pressure (20°C)</b>	1MPa Note 2)
<b>Operating vacuum pressure</b>	-100kPa
<b>Proof pressure (20°C)</b>	3MPa
<b>Ambient and fluid temperature</b>	-5°C to 60°C
<b>Threads</b>	JIS B0203 (taper threads for piping)

Note 1) Refer to particulate generation grade classifications

This falls outside of the grade because grease is applied to the internal seal materials.

Note 2) The maximum operating pressure is the value at 20°C. Refer to the operating pressure curve for other temperatures.

## Principal Part Materials

Model	Series KPQ	Series KPG
<b>Body</b>	Polypropylene resin	
<b>Stud</b>	Brass (electroless nickel plated)	SUS304 stainless steel
<b>Chuck</b>	SUS304 stainless steel	
<b>Guide, Stopper</b>	Brass (electroless nickel plated)	SUS304 stainless steel
<b>Collet, Release button</b>	Polypropylene resin	
<b>Seal, O-ring, Bumper</b>	NBR	

## Particulate Generation Grade Classifications

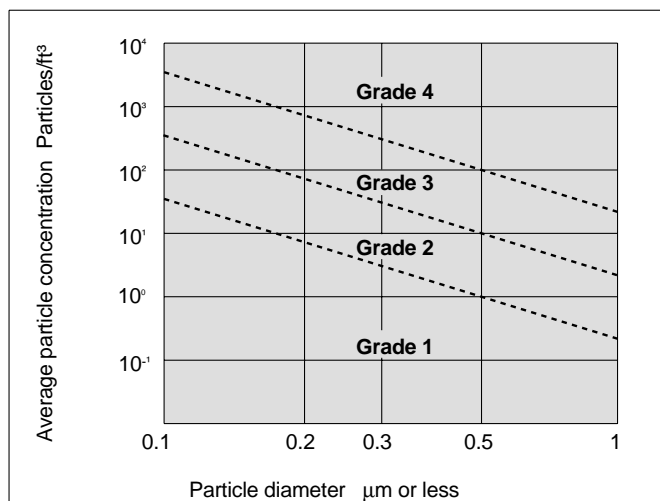

## Relationship of Operating Temperature and Maximum Operating Pressure

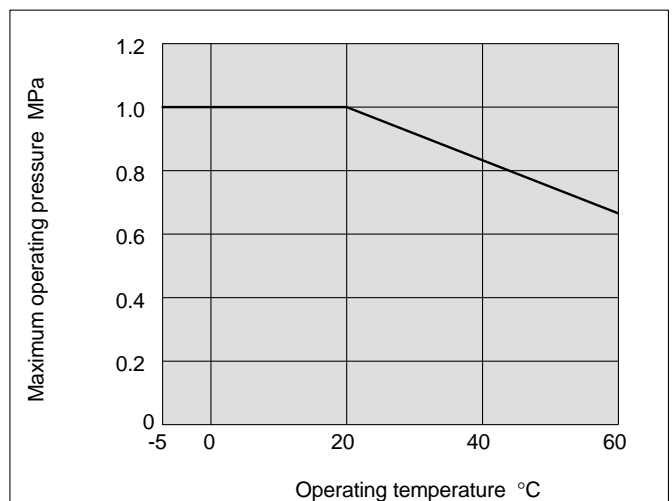



## How to Order

**Clean One-touch fitting**

**Specifications**

Symbol	Specifications (metal part materials)
<b>Q</b>	Brass (electroless nickel plated)
<b>G</b>	Stainless steel (SUS304)

**Model**

<b>H</b>	Male connector, Straight union
<b>L</b>	Union elbow, Male elbow
<b>T</b>	Male branch tee, Union tee
<b>Y</b>	Male run tee
<b>U</b>	Male branch, Union "Y"
<b>R</b>	Plug-in reducer

**Thread connection**

<b>M5</b>	M5 x 0.8
<b>01</b>	R 1/8
<b>02</b>	R 1/4
<b>03</b>	R 3/8
<b>04</b>	R 1/2
<b>00</b>	Same dia. tubing
<b>04</b>	ø4
<b>06</b>	ø6
<b>08</b>	ø8
<b>10</b>	ø10
<b>12</b>	ø12

**Tubing (rod) connection**

<b>04</b>	ø4	Different dia. tubing (plug-in reducer)
<b>06</b>	ø6	
<b>08</b>	ø8	
<b>10</b>	ø10	
<b>12</b>	ø12	

**Applicable tubing O.D.**

<b>04</b>	ø4
<b>06</b>	ø6
<b>08</b>	ø8
<b>10</b>	ø10
<b>12</b>	ø12

**Applicable fitting size**

<b>04</b>	ø4
<b>06</b>	ø6
<b>08</b>	ø8
<b>10</b>	ø10
<b>12</b>	ø12

**Plug**

**Clean One-touch fitting**

## Construction

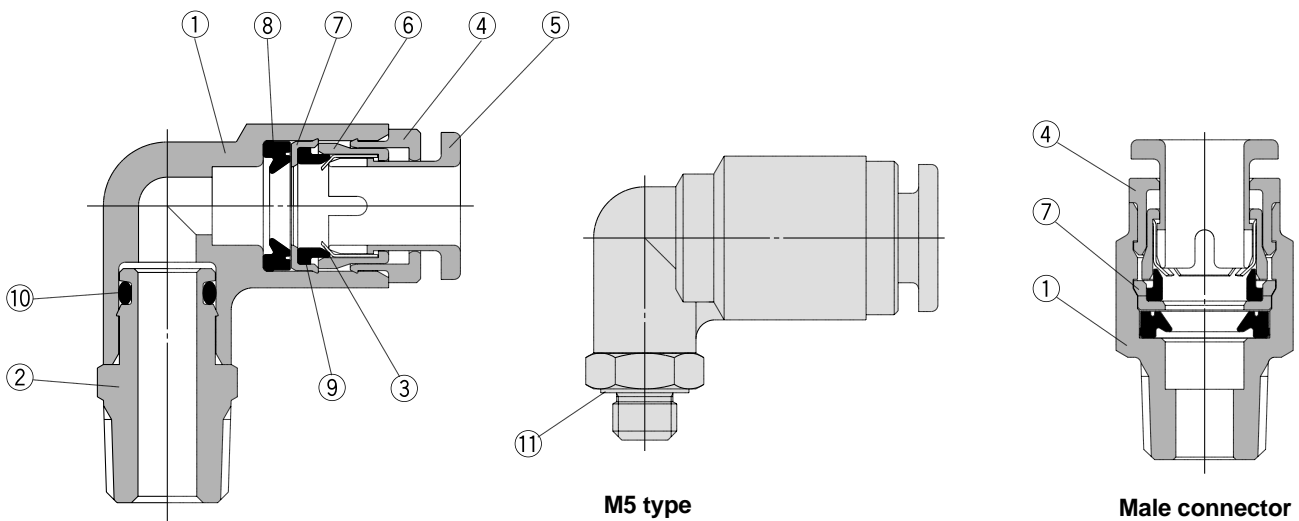

### Parts list

No.	Description	Material	
		Series KPQ	Series KPG
1	Body	Polypropylene resin	
		With male connector	SUS304 stainless steel
2	Stud	Brass (electroless nickel plated)	SUS304 stainless steel
3	Chuck	SUS304 stainless steel	
4	Guide	Brass (electroless nickel plated)	
		With male connector	SUS304 stainless steel
5	Release button	Polypropylene resin (color: light gray)	Polypropylene resin (color: light blue)
6	Collet	Polypropylene resin	
7	Stopper	SUS304 stainless steel	
		With male connector	Polypropylene resin
8	Seal	NBR	
9	Bumper	NBR	
10	O-ring	NBR	
11	Gasket	SUS304 stainless steel + NBR	

**K**

**M**

**H**

**D**

**MS**

**T**

**LQ**

**Clean Room**

# Series KPQ/KPG

## Dimensions

### Male Connector: KPQH, KPGH

(M5)



(R)



Applicable tubing O.D. mm	Connection threads R	Model		H (width across flats)	øD	L	A*	M	Effective area mm <sup>2</sup>		Weight g
									TPH	TPS	
4	M5	KPQH04-M5	—	8	10	25.4	22.5	18	4	4	4
		—	KPGH04-M5			25.9					
	1/8	KPQH04-01	KPGH04-01	10	—	25.4	19.5	—	—	—	7
1/4	KPQH04-02	KPGH04-02	14	—	22.9	17	—	—	—	—	12
6	M5	KPQH06-M5	—	8	12	26.3	23	19.5	10	10	5
		—	KPGH06-M5			26.8					
	1/8	KPQH06-01	KPGH06-01	12	—	25.6	19.5	—	—	—	7
1/4	KPQH06-02	KPGH06-02	14	—	26.1	20	—	—	—	—	14
8	1/8	KPQH08-01	KPGH08-01	14	—	32.6	26.5	21.5	26	18	14
		—	KPGH08-02			30.6					
	1/4	KPQH08-02	KPGH08-02	—	—	37.6	31.5	—	—	—	—
10	3/8	KPQH10-03	KPGH10-03	17	—	33	26.5	24	41	29	23
	1/2	KPQH12-04	KPGH12-04			19					
12	1/2	KPQH12-04	KPGH12-04	22	—	34.1	26	25	58	46	46

\* Reference dimension for R threads after installation

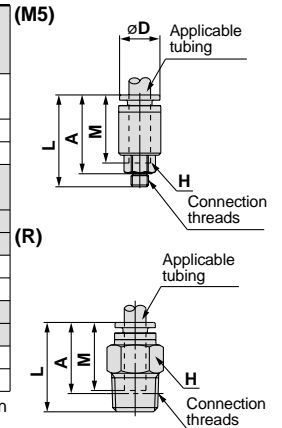

### Male Elbow: KPQL, KPGL

(M5)



(R)



Applicable tubing O.D. mm	Connection threads R	Model		H (width across flats)	Note 1) øD <sub>1</sub>	øD <sub>2</sub>	L <sub>1</sub>	L <sub>2</sub>	A*	M	Effective area mm <sup>2</sup>		Weight g
											TPH	TPS	
4	M5	KPQL04-M5	KPGL04-M5	8	10.4	8	20.7	15.3	17	18	4	4	4
		—	KPGL04-01					10	22				
	1/4	KPQL04-02	KPGL04-02	14	—	26	25	—	—	—	—	—	19
6	M5	KPQL06-M5	KPGL06-M5	8	12.8	8	22.8	15.8	18.5	19.5	10	10	12
		—	KPGL06-01					10	23.2				
	1/4	KPQL06-02	KPGL06-02	14	—	27.2	27.5	—	—	—	—	—	20
8	1/8	KPQL08-01	KPGL08-01	12	15.2	12	26.3	24.4	26	21.5	26	18	13
		—	KPGL08-02					14	28.4				
	1/4	KPQL10-02	KPGL10-02	—	—	29.9	33	—	—	—	—	—	26
10	3/8	KPQL10-03	KPGL10-03	17	18.5	17	29.4	31.9	34.5	24	41	29	36
	1/2	KPQL12-04	KPGL12-04					22	—				
12	1/2	KPQL12-04	KPGL12-04	22	20.9	—	31.4	37.1	39.5	25	58	46	65

\* Reference dimension for R threads after installation Note 1) øD<sub>1</sub> indicates the maximum diameter.

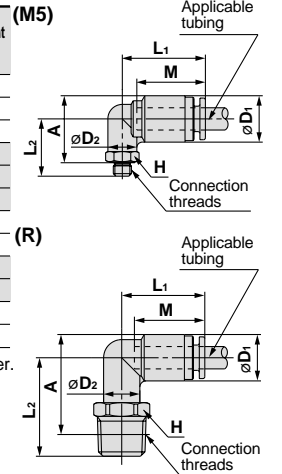

### Union Tee: KPQT, KPQT

(M5)



(R)



Applicable tubing O.D. mm	Connection threads R	Model		H (width across flats)	Note 1) øD <sub>1</sub>	øD <sub>2</sub>	L <sub>1</sub>	L <sub>2</sub>	A*	M	Effective area mm <sup>2</sup>		Weight g
											TPH	TPS	
4	M5	KPQT04-M5	KPQT04-M5	8	10.4	8	20.7	15.3	17	18	4	4	6
		—	KPQT04-01					10	22				
	1/4	KPQT04-02	KPQT04-02	14	—	26	25	—	—	—	—	—	19
6	M5	KPQT06-M5	KPQT06-M5	8	12.8	8	22.8	15.8	18.5	19.5	10	10	7
		—	KPQT06-01					10	23.2				
	1/4	KPQT06-02	KPQT06-02	14	—	27.2	27.5	—	—	—	—	—	20
8	1/8	KPQT08-01	KPQT08-01	12	15.2	12	26.3	24.4	26	21.5	26	18	14
		—	KPQT08-02					14	28.4				
	1/4	KPQT10-02	KPQT10-02	—	—	29.9	33	—	—	—	—	—	22
10	3/8	KPQT10-03	KPQT10-03	17	18.5	17	29.4	31.9	34.5	24	41	29	39
	1/2	KPQT12-03	KPQT12-03					22	—				
12	1/2	KPQT12-04	KPQT12-04	22	20.9	—	31.4	37.1	39.5	25	58	46	38

\* Reference dimension for R threads after installation Note 1) øD<sub>1</sub> indicates the maximum diameter.

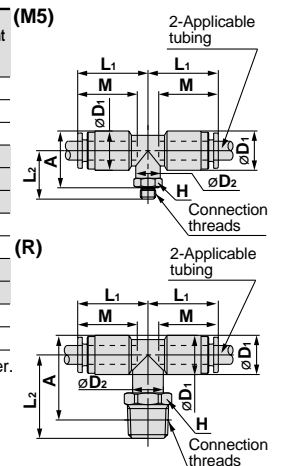

## Dimensions

### Male Run Tee: KPQY, KPGY



Applicable tubing O.D. mm	Connection threads R	Model		H (width across flats)	Note 1) $\phi D_1$	$\phi D_2$	L <sub>1</sub>	L <sub>2</sub>	A*	M	Effective area mm <sup>2</sup>		Weight g
		TPH	TPS										
4	M5	KPQY04-M5	KPGY04-M5	8	10.4	8	20.7	15.3	32.5	18	4	4	6
	1/8	KPQY04-01	KPGY04-01	10		10		22	36.5				13
	1/4	KPQY04-02	KPGY04-02	14		14		26	40.5				19
6	M5	KPQY06-M5	KPGY06-M5	8	12.8	8	22.8	15.8	35	19.5	10	10	7
	1/8	KPQY06-01	KPGY06-01	10		10		23.2	40				14
	1/4	KPQY06-02	KPGY06-02	14		14		27.2	44				20
8	1/8	KPQY08-01	KPGY08-01	12	15.2	12	26.3	24.4	44.5	21.5	26	18	14
	1/4	KPQY08-02	KPGY08-02	14				14	28.4				48.5
10	1/4	KPQY10-02	KPGY10-02	17	18.5	17	29.4	29.9	53.5	24	41	29	29
	3/8	KPQY10-03	KPGY10-03	17				17	31.9				55
12	3/8	KPQY12-03	KPGY12-03	22	20.9	17	31.4	33.1	58	25	58	46	41
	1/2	KPQY12-04	KPGY12-04	22				22	37.1				60.5

\* Reference dimension for R threads after installation Note 1)  $\phi D_1$  indicates the maximum diameter.

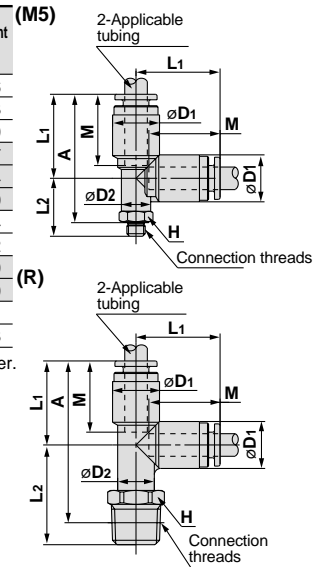

### Male Branch: KPQU, KPGU



Applicable tubing O.D. mm	Connection threads R	Model		H (width across flats)	Note 1) $\phi D$	L	P	A*	M	Effective area mm <sup>2</sup>		Weight g
		TPH	TPS									
4	M5	KPQU04-M5	KPGU04-M5	11	10.4	41.7	10.4	38	18	4	4	10
	1/8	KPQU04-01	KPGU04-01			44.2		38				11
	1/4	KPQU04-02	KPGU04-02			48.2		42				20
6	M5	KPQU06-M5	KPGU06-M5	13	12.8	44.9	12.8	41.5	19.5	10	10	12
	1/8	KPQU06-01	KPGU06-01			47.4		41.5				11
	1/4	KPQU06-02	KPGU06-02			51.4		45.5				21
8	1/8	KPQU08-01	KPGU08-01	17	15.2	55.5	15.2	49.5	21.5	26	18	15
	1/4	KPQU08-02	KPGU08-02			60.6		54.5				23
10	1/4	KPQU10-02	KPGU10-02	19	18.5	63.8	18.5	58	24	41	29	30
	3/8	KPQU10-03	KPGU10-03			61.3		55				40
12	3/8	KPQU12-03	KPGU12-03	22	20.9	67	20.9	60.5	25	58	46	40
	1/2	KPQU12-04	KPGU12-04			71.4		63.5				65

\* Reference dimension for R threads after installation Note 1)  $\phi D$  indicates the maximum diameter.

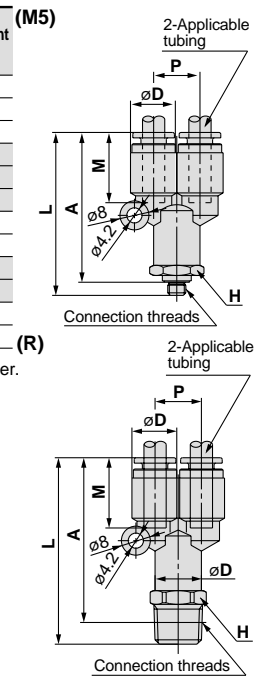

### Straight Union: KPQH, KPGH



Applicable tubing O.D. mm	Model		Note 1) $\phi D$	L	M	Effective area mm <sup>2</sup>		Weight g
	TPH	TPS						
4	KPQH04-00	KPGH04-00	10.4	37.4	18	4	4	4
6	KPQH06-00	KPGH06-00	12.8	39.6	19.5	10	10	6
8	KPQH08-00	KPGH08-00	15.2	44.4	21.5	26	18	10
10	KPQH10-00	KPGH10-00	18.5	48.6	24	41	29	15
12	KPQH12-00	KPGH12-00	20.9	50.6	25	58	46	18

Note 1)  $\phi D$  indicates the maximum diameter.

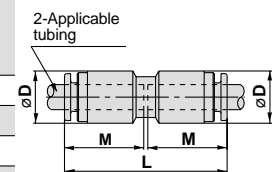

- K
- M
- H
- D
- MS
- T
- LQ

Clean Room

# Series KPQ/KPG

## Elbow: KPQL, KPGL



Applicable tubing O.D. mm	Model		Note 1) $\phi D$	L	Q	M	Effective area mm <sup>2</sup>		Weight g
							TPH	TPS	
4	KPQL04-00	KPGL04-00	10.4	20.7	4.5	18	3.5	3.5	3
6	KPQL06-00	KPGL06-00	12.8	22.8	5.3	19.5	9	9	7
8	KPQL08-00	KPGL08-00	15.2	26.3	6	21.5	22	15	11
10	KPQL10-00	KPGL10-00	18.5	29.4	6.8	24	35	25	16
12	KPQL12-00	KPGL12-00	20.9	31.4	7.5	25	50	40	20

Note 1)  $\phi D$  indicates the maximum diameter.

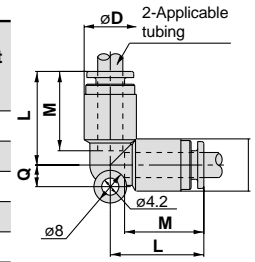

## Union Tee: KPQT, KPGT



Applicable tubing O.D. mm	Model		Note 1) $\phi D$	L	Q	M	Effective area mm <sup>2</sup>		Weight g
							TPH	TPS	
4	KPQT04-00	KPGT04-00	10.4	20.7	4.5	18	4	4	7
6	KPQT06-00	KPGT06-00	12.8	22.8	5.3	19.5	10	10	9
8	KPQT08-00	KPGT08-00	15.2	26.3	6	21.5	26	18	16
10	KPQT10-00	KPGT10-00	18.5	29.4	6.8	24	41	29	25
12	KPQT12-00	KPGT12-00	20.9	31.4	7.5	25	58	46	29

Note 1)  $\phi D$  indicates the maximum diameter.

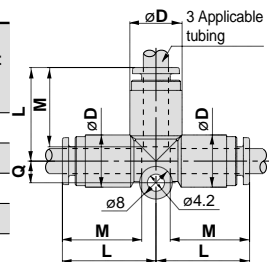

## Union "Y": KPQU, KPGU



Applicable tubing O.D. mm	Model		Note 1) $\phi D$	L <sub>1</sub>	L <sub>2</sub>	P	Q	M	Effective area mm <sup>2</sup>		Weight g
									TPH	TPS	
4	KPQU04-00	KPGU04-00	10.4	38.8	20.6	10.4	9.7	18	4	4	7
6	KPQU06-00	KPGU06-00	12.8	42.1	22.8	12.8	11.7	19.5	10	10	10
8	KPQU08-00	KPGU08-00	15.2	48.7	27.5	15.2	13.7	21.5	26	18	17
10	KPQU10-00	KPGU10-00	18.5	54	30.7	18.5	16.1	24	41	29	26
12	KPQU12-00	KPGU12-00	20.9	57.2	32.9	20.9	18.1	25	58	46	32

Note 1)  $\phi D$  indicates the maximum diameter.

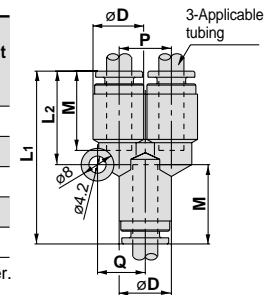

## Plug-in Reducer: KPQR, KPGR



Applicable tubing O.D. mm	Applicable fitting size $\phi d$	Model		Note 1) $\phi D$	L	A	M	Effective area mm <sup>2</sup>		Weight g
								TPH	TPS	
4	6	KPQR04-06	KPGR04-06	10.4	39.4	20.1	18	4	4	3
	8	KPQR04-08	KPGR04-08		41.9	20.2				
6	8	KPQR06-08	KPGR06-08	12.8	42.5	20.8	19.5	10	10	4
	10	KPQR06-10	KPGR06-10		45	21.2				
8	10	KPQR08-10	KPGR08-10	15.2	47	23.2	21.5	26	18	5
	12	KPQR08-12	KPGR08-12		48	23.2				
10	12	KPQR10-12	KPGR10-12	18.5	50.5	25.7	24	41	29	9

Note 1)  $\phi D$  indicates the maximum diameter.

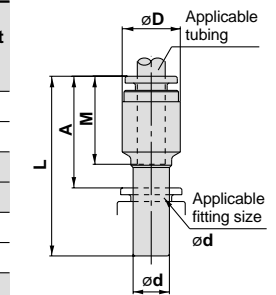

## Plug: KPP



Applicable fitting size $\phi d$	Model	$\phi D$	L	A	Weight g
4	KPP-04	6	32	13.8	0.4
6	KPP-06	8	35	15.7	0.7
8	KPP-08	10	39	17.3	1.1
10	KPP-10	12	43	19.2	1.7
12	KPP-12	14	45.5	20.7	2.5

\* The plug is common for series KPQ, KPG and KPP.

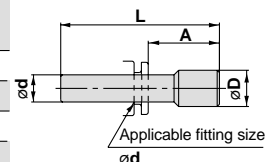

Clean  
Tubing

# Polyolefin Tubing Series *TPH*

## Series

● – 20m bundle □ – 100m bundle



Designation	TPH0425	TPH0604	TPH0806	TPH1075	TPH1209
O.D. mm	4	6	8	10	12
I.D. mm	2.5	4	6	7.5	9

White (W)	●	●	●	●	●
Black (B)	●	●	●	●	●
Red (R)	●	●	●	●	●
Blue (BU)	●	●	●	●	●
Yellow (Y)	●	●	●	●	●
Green (G)	●	●	●	●	●

## Specifications

Fluid	Air, Nitrogen gas, Water (pure water) <small>Note 1)</small>				
Maximum operating pressure (at 20°C)	1.0MPa <small>Note 2)</small>		0.7MPa <small>Note 2)</small>		
Min. bending radius mm	15	25	35	45	55
Burst pressure	Refer to the burst pressure characteristics curve.				
Operating temperature	– 20 to 80°C, For water 5 to 80°C				
Material	Polyolefin resin				

Note 1) Consult SMC regarding other fluids.

Note 2) The maximum operating pressure is the value at 20°C. Refer to the burst pressure characteristics curve for other temperatures. Furthermore, an abnormal temperature rise due to adiabatic compression can cause tubing to burst.

Note 3) The minimum bending radius indicates the value at a temperature of 20°C with an outside diameter rate of change of 10% or less. At higher temperatures the outside diameter rate of change may exceed 10% within the minimum bending radius.

## Burst Pressure Characteristics Curve and Operating Pressure

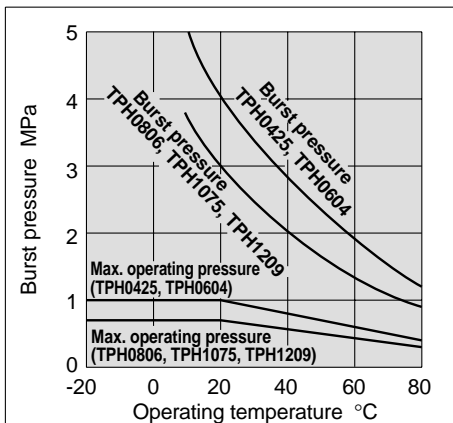

## How to Order

**TPH0604 B 20**

Tubing designation ●

Colour ●

Symbol	Colour
W	White
B	Black
R	Red
BU	Blue
Y	Yellow
G	Green

Roll length ●

Symbol	Length
20	20m bundle
100	100m bundle

K

M

H

D

MS

T

LQ

Clean  
Room

Clean  
Tubing

# Soft Polyolefin Tubing Series *TPS*



## Series

● -20m bundle □ -100m bundle

Designation	TPS0425	TPS0604	TPS0805	TPS1065	TPS1208
O.D. mm	4	6	8	10	12
I.D. mm	2.5	4	5	6.5	8

White (W)	●	●	●	●	●
Black (B)	●	●	●	●	●
Red (R)	●	●	●	●	●
Blue (BU)	●	●	●	●	●
Yellow (Y)	●	●	●	●	●
Green (G)	●	●	●	●	●

## Specifications

Fluid	Air, Nitrogen gas, Water (pure water) <small>Note 1)</small>				
Maximum operating pressure (at 20°C)	0.7MPa <small>Note 2)</small>				
Min. bending radius mm	10	20	25	30	40
Burst pressure	Refer to the burst pressure characteristics curve.				
Operating temperature	- 20 to 80°C, For water 5 to 80°C				
Material	Polyolefin resin				

Note 1) Consult SMC regarding other fluids.

Note 2) The maximum operating pressure is the value at 20°C. Refer to the burst pressure characteristics curve for other temperatures. Furthermore, an abnormal temperature rise due to adiabatic compression can cause tubing to burst.

Note 3) The minimum bending radius indicates the value at a temperature of 20°C with an outside diameter rate of change of 10% or less. At higher temperatures the outside diameter rate of change may exceed 10% within the minimum bending radius.

## Burst Pressure Characteristics Curve and Operating Pressure

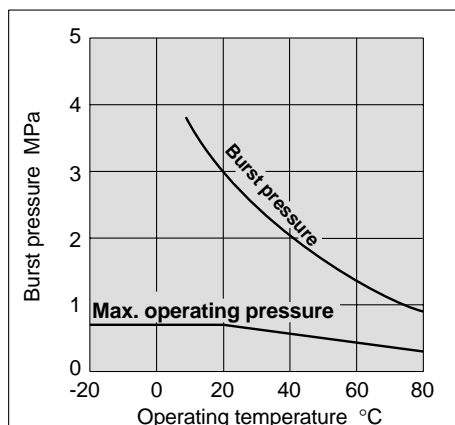

## How to Order

TPS0604 B-20

Tubing designation ●

Colour ●

Roll length ●

Symbol	Colour
W	White
B	Black
R	Red
BU	Blue
Y	Yellow
G	Green

Symbol	Length
20	20m bundle
100	100m bundle



# Related Equipment Clean Series Tubing

## Polyurethane Tubing *Series 10-TU*

10 – TU0425 BU – 20

● Clean series

Tubing designation ●

● Colour ●

B	Black
W	White
R	Red
BU	Blue
Y	Yellow
G	Green
C	Clear
YR	Orange

● Roll length ●

20	20m bundle
----	------------

### Series

● – 20m bundle

Designation	Tubing size				
	Metric size (series TU)				
	10-TU0425	10-TU0604	10-TU0805	10-TU1065	10-TU1208
O.D. mm	4	6	8	10	12
I.D. mm	2.5	4	5	6.5	8
Black	●	●	●	●	●
White (W)	●	●	●	●	●
Red (R)	●	●	●	●	●
Blue (BU)	●	●	●	●	●
Yellow (Y)	●	●	●	●	●
Green (G)	●	●	●	●	●
Clear (C)	●	●	●	●	●
Orange (YR)	●	●	●	●	●

### Specifications

Fluid	Air, Water				
Maximum operating pressure (at 20°C)	0.8MPa				
Burst pressure	Refer to the burst pressure characteristics curve.				
Min. bending radius mm <sup>Note)</sup>	10	15	20	27	35
Operating temperature	Air: -20 to 60°C, Water: 0 to 40°C (with no freezing)				
Material	Polyurethane				

Note) The minimum bending radius indicates the value at a temperature of 20°C with an outside diameter rate of change of 10% or less. At higher temperatures the outside diameter rate of change may exceed 10% within the minimum bending radius.

## Polyurethane Coiled Tubing *Series 10-TCU*



### Specifications

Model	10-TCU 0425B-1	10-TCU 0425B-2	10-TCU 0425B-3	10-TCU 0604B-1	10-TCU 0604B-2	10-TCU 0604B-3	10-TCU 0805B-1
Number of cores	1 core	2 cores	3 cores	1 core	2 cores	3 cores	1 core
Tubing O.D. mm	4		6		8		
Tubing I.D. mm	2.5		4		5		
Fluid	Air						
Maximum operating pressure (at 20°C)	0.8MPa						
Burst pressure	Refer to the burst pressure characteristics curve.						
Operating temperature	-20 to 60°C						
Material	Polyurethane						
Colour	Black						

## Polyurethane Flat Tubing *Series 10-TFU*



### Specifications

Model	10-TFU 0425B-2	10-TFU 0425B-3	10-TFU 0604B-2	10-TFU 0604B-3	10-TFU 0805B-2	10-TFU 0805B-3
Number of cores	2 cores	3 cores	2 cores	3 cores	2 cores	3 cores
Tubing O.D. mm	4		6		8	
Tubing I.D. mm	2.5		4		5	
Fluid	Air					
Maximum operating pressure (at 20°C)	0.8MPa					
Burst pressure	Refer to the burst pressure characteristics curve.					
Operating temperature	-20 to 60°C					
Material	Polyurethane					
Colour	Black					
Min. bending radius mm	10		15		20	
Tubing roll length m	10					

K□

M□

H□

D□

MS

T□

LQ

Clean Room

# Clean Blowing System Related Equipment

## Air Operated Valve Series LV

Low particulate generating valve with excellent corrosion resistance

### Series LVA



### Series LVC



### Threaded type/Series LVA (basic type)

Note 1) PFA body not available for LVA10

Series	Orifice size (mm)	Body material	Port size Rc				
			1/8	1/4	3/8	1/2	3/4
LVA10	ø2	Note 1)	●	●			
LVA20	ø4	PFA	○	●			
LVA30	ø8	PPS		○	●		
LVA40	ø12	SUS316			○	●	
LVA50	ø20	SUS316				○	●

○: Body material SUS316 only

### Integral fitting type/Series LVC (basic type)

Series	Orifice size (mm)	Body material	Tubing size												
			Metric sizes					Inch sizes							
			4	6	8	10	12	19	1/8	3/16	1/4	3/8	1/2	3/4	
LVC20	ø4	PFA	●	●							●	●	●		
LVC30	ø8			●	●	●						●	●		
LVC40	ø10					●	●						●	●	
LVC50	ø16						●	●						●	●

## Clean Regulator Series SR

Contamination controlled stainless steel regulator

### Series SRH



### Series SR



### Series SRH

Series	Port size Rc						Liquid-contact part materials	
	1/8	1/4	3/8	1/2	9/16-18UNF	7/8-14UNF	Body	Diaphragm
SRH3000	●	●			●		SUS316L (fluid-contact parts SUS316)	Liquid-contact surfaces PTFE + Fluoro rubber (grade A) Fluoro rubber (grade B)
SRH4000		●	●	●		●		

### Series SR

Series	Port size Rc					Liquid-contact part materials	
	M5	1/8	1/4	3/8	1/2	Body	Diaphragm
SR1000	●					SUS316	Fluoro rubber Fluoro rubber host with PTFE on liquid-contact surfaces
SR3000		●	●				
SR4000			●	●	●		

## Clean Gas Filter Series SF

0.01mm particles 100% eliminated

### Series SFA



### Series SFB



### Series SFC



### Cartridge type

Series	Type	Principal materials			Thread type	Port size	
		Element	Housing	Seal		M5	1/4
100 SFA 200 300	Disk	PTFE + Polyethylene	SUS316 (electropolished)	Fluoro rubber (FPM)	Rc NPT TSJ UOJ		●
SFB100	Straight	PTFE membrane				●	●

### Disposable type

Series	Type	Principal materials			Thread type	Port size	
		Element	Housing	Seal		1/4	3/8
SFB300	Straight	PTFE membrane	SUS316 (electropolished)	-	Rc TSJ URJ	●	
SFC100	Multistage Disk	PTFE membrane PVDF holder		O-ring PTFE		●	●