

Air-hydro Unit CC Series

The air-hydro unit consists of a converter and a valve unit that are compactly integrated. It converts air pressure to an equivalent hydraulic pressure, and this hydraulic pressure is used for operating an actuator, thus solving the problem that is associated with the compression characteristics of air. Thus, in spite of using pneumatic equipment, it performs similarly to a hydraulic unit, operating at a constant speed during starting or in the presence of load fluctuations, and at the same time solving the problems of sticking and slipping associated with low speed operations. This unit is ideal for achieving accurate and constant speed of the cylinder, intermediate stopping, skip movement, or for slow operation of a rotary actuator.

■ High cylinder operation speed

Through the availability of a wide range of series in terms of converter capacity and valve unit flow rate control capability, speeds as high as 200 mm/s (throttle valve) can be achieved with a $\varnothing 80$ cylinder. (Operating pressure: 0.5 MPa, unloaded, piping: bore 19 mm x 1 m)

Air-hydro Converter CCT Series



Examples of Application

① Function of stop valve

Prevents load dropping (In an emergency)

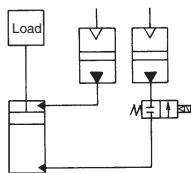

Multipoint intermediate stops

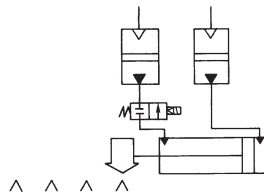

Fixed end point

(Not only solid but also liquid is available if there is pump mechanism at the end.)

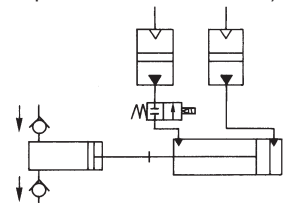

② Function of skip valve

Fast forward to working process

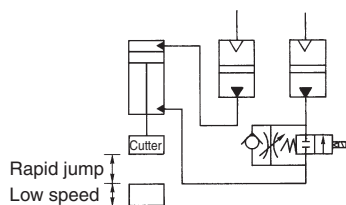

③ Flow control valve

(With pressure compensation)

Uniform driving for load fluctuations

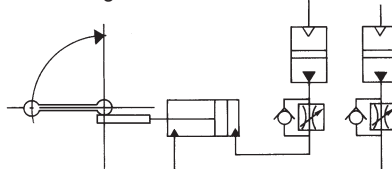

④ Throttle valve/Speed controller

- Working without jumping at low speeds or when starting
- Control with throttle valve and speed controller when transferring and carrying

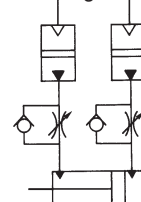



Air-hydro Unit

CC Series

Caution

Be sure to read this before handling the products.

How to Select

① Select the bore size of air-hydro cylinder

First of all, select a bore size from data D <Theoretical Output Table>. When making a selection, the ratio between the theoretical output and the load should be 0.5 or less.

② Select converter

Select the nominal diameter and the effective oil level stroke from data A, <Cylinder Displacement and Converter Capacity Diagram>. When selecting a converter by its nominal diameter, the converter's oil level speed should be 0.2 m/s or less.

Cautions of Selection

① Make sure to select a cylinder and a rotary actuator for an air-hydro operation. Do not use these for pneumatic operations because they will lead to oil leaks.

Air-hydro cylinder: CA1□H□-□,
CQ2□H□-□,
CS1□H□-□,
CM2□H□-□,
CG1□H□-□(to Ø 63),
HC03-X1-□X□

Air-hydro rotary actuator:
CRA1H□-□

② When determining the size of a converter based on the <Cylinder Displacement and Converter Capacity Diagram>, do not select a converter bore that is too small for the cylinder's bore size because this will increase the oil level speed, causing the oil to blow out. Thus, select a converter bore so that the oil level speed will be 200 mm/s or less.

Data A Volume of cylinder/Capacity of converter

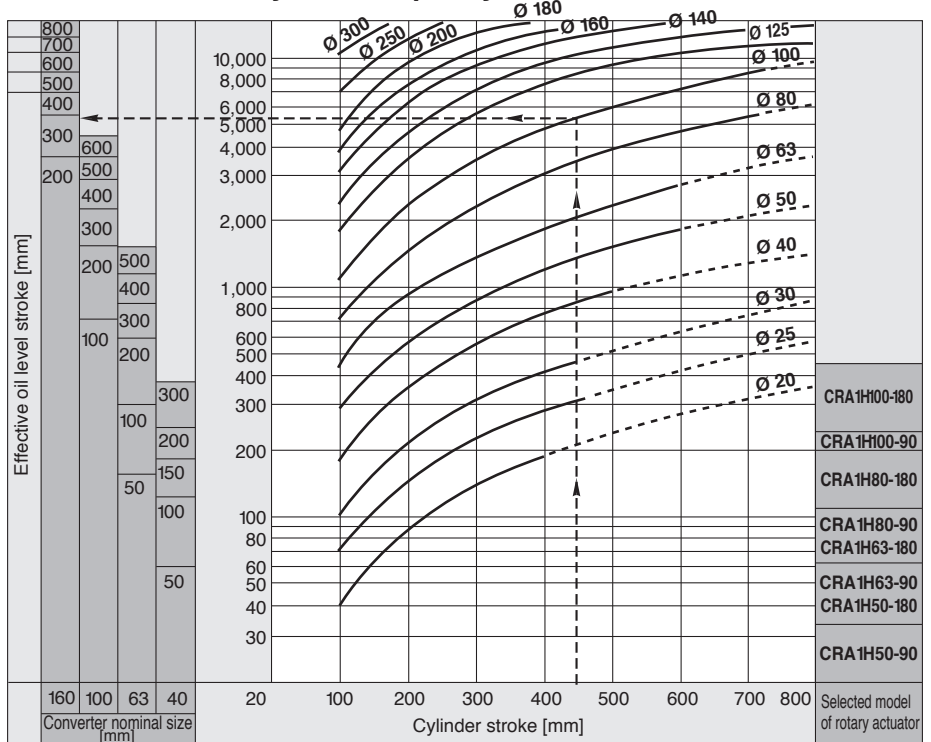

How to view the diagram (ex: when using a Ø 100 to 450 st cylinder): Draw a line perpendicularly from the cylinder stroke of 450 to the point at which it intersects the (curve) cylinder bore size of Ø 100, and extend it to the left to obtain the displacement of approximately 5.300 cm³. Then, select a converter with a larger capacity. The converter will be Ø 160 to 300. To obtain the capacity of the converter, multiply the cylinder displacement by approximately 1.5.

Note: Select the nominal diameter of the converter so that the converter's oil level speed does not exceed 0.2 m/s.

Data **D** Theoretical output table

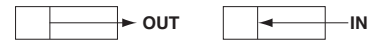

Bore [mm]	Port size [mm]	Operating direction	Piston area [mm ²]	Operation pressure [MPa]									Unit: N
				0.2	0.3	0.4	0.5	0.6	0.7	0.8	0.9	1.0	
20	8	OUT	314	62.8	94.2	126	157	188	220	251	283	314	
		IN	264	52.8	79.2	106	132	158	185	211	238	264	
25	10	OUT	491	98.2	147	196	246	295	344	393	442	491	
		IN	412	82.4	124	165	206	247	288	330	371	412	
32	12	OUT	804	161	241	322	402	482	563	643	724	804	
		IN	691	138	207	276	346	415	484	553	622	691	
40	14	OUT	1260	252	378	504	630	756	882	1010	1130	1260	
		IN	1100	220	330	440	550	660	770	880	990	1100	
50	20	OUT	1960	392	588	784	980	1180	1370	1570	1760	1960	
		IN	1650	330	495	660	825	990	1160	1320	1490	1650	
63	20	OUT	3120	624	936	1250	1560	1870	2180	2500	2810	3120	
		IN	2800	560	840	1120	1400	1680	1960	2240	2520	2800	
80	25	OUT	5030	1010	1510	2010	2520	3020	3520	4020	4530	5030	
		IN	4540	908	1360	1820	2270	2720	3180	3630	4090	4540	
100	30	OUT	7850	1570	2360	3140	3930	4710	5500	6280	7070	7850	
		IN	7150	1430	2150	2860	3580	4290	5010	5720	6440	7150	
125	36	OUT	12300	2460	3690	4920	6150	7380	8610	9840	11100	12300	
		IN	11300	2260	3390	4520	5650	6780	7910	9040	10200	11300	
140	36	OUT	15400	3080	4620	6160	7700	9240	10800	12300	13900	15400	
		IN	14400	2880	4320	5760	7200	8640	10100	11500	13000	14400	
160	40	OUT	20100	4020	6030	8040	10100	12100	14100	15500	18100	20100	
		IN	18800	3760	5640	7520	9400	11300	13200	15000	16900	18800	
180	45	OUT	25400	5080	7620	10200	12700	15200	17800	20300	22900	25400	
		IN	23900	4780	7170	9560	12000	14300	16700	19100	21500	23900	
200	50	OUT	31400	6280	9420	12600	15700	18800	22000	25100	28300	31400	
		IN	29500	5900	8850	11800	14800	17700	20700	23600	26600	29500	
250	60	OUT	49100	9820	14700	19600	24600	29500	34400	39300	44200	49100	
		IN	46300	9260	13900	18500	23200	27800	32400	37000	41700	46300	
300	70	OUT	70700	14100	21200	28200	35400	42400	49500	56600	63600	70700	
		IN	66800	13400	20000	26700	33400	40100	46800	53400	60100	66800	



Air-hydro Unit

CC Series

Specific Product Precautions

Be sure to read this before handling the products.

Air supply

1. A mist separator prevents the intermixing of drainage, preventing the air-hydro unit from malfunctioning, and prolonging the life of the oil.

Environment

1. Avoid use near fire.
2. Don't use in the clean room.

Mounting

1. Install the converter vertically.
2. Install the converter at a position that is higher than the cylinder. If placed lower than the cylinder, air accumulates in the cylinder. Use the air bleed valve on the cylinder to bleed the air. If the cylinder is not provided with an air bleed valve, loosen the hydraulic pipe to bleed.
3. Leakage associated with the sliding movement inevitably occurs. In particular, with the single side hydro unit, the operating oil that leaks to the pneumatic side will be discharged from the switching valve, thus soiling the switching valve. Thus, install an exhaust cleaner (AMC Series). (Fig.6)

When the oil case of the exhaust cleaner becomes full, operating oil will blow out of the exhaust cleaner. Therefore, open the drain valve on a regular basis.

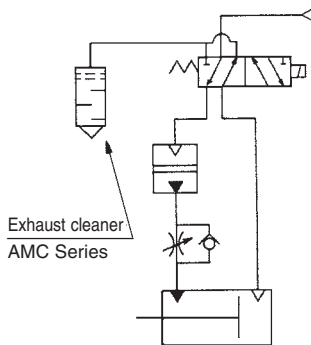

Figure 6

Piping

1. Before connecting the pipes, remove any foreign matter.
2. The {T Series W (white)} nylon tubing can be used for hydraulic piping. Self-aligning fittings can be used for hydraulic piping, but one-touch fittings cannot be used.
3. Make sure that there are no extreme differences in the bore of the pipes used for hydraulic piping. Also check for protrusions or burrs.
4. Prevent air from being drawn into the hydraulic piping.
5. When operating a stop valve or a skip valve with a solenoid valve, considering it is an external pilot, provide pneumatic piping with 0.3 to 0.7 MPa of air pressure. The pressure for the pilot must be set to the operating pressure of the cylinder or higher.
6. To pneumatically operate a stop valve or a skip valve, set the signal air pressure to 0.3 to 0.7 MPa. The pneumatic operating pressure must be set to the cylinder's operating pressure or higher.

Piping

7. The stop and skip valves must be "normally closed".
8. Be aware that the specified speed might not be attained if there is restriction in the fittings or there are 90° bends.
9. Air bubbles could form during operation due to cavitation. To prevent this:
 - Configure the piping from the cylinder to the converter to have an ascending gradient.
 - Shorten the hydraulic piping.

Maintenance

Double-side hydro

1. Even as a double side hydro unit, leakage occurs with the sliding movement of the air-hydro cylinder, increasing the converter's operating fluid in one area and decreasing it in the other. Fig. 7 provides a countermeasure circuit. Maintain the converter's oil level at an appropriate level by opening valve A.

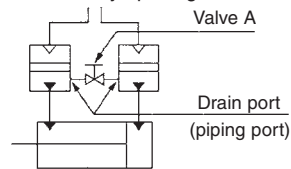

Figure 7

Single-side hydro

2. The basic composition of the air-hydro system is the double side hydro; however, it can also be used as a single side hydro. The viscosity of the operating oil of the single side hydro is approximately one half of the double side hydro. The speed will be approximately 1.4 times the data given on page 3. When the system is used as a single side hydro, air could become intermixed with the operating oil, leading to the symptoms listed below:
 - 1- Cylinder's speed is not constant.
 - 2- Stopping accuracy of the stop valve decreases.
 - 3- Overrun of the skip valve increases.
 - 4- The flow control valve with pressure compensator knocks (even with a small flow rate).Therefore, it is necessary to check periodically to prevent air from intermixing with the oil. If the symptoms described above occur, air must be bled. In particular, to prevent "4", use a double side hydro.

Lubrication

If the converter is positioned higher than the cylinder:

1. Make sure to move the cylinder's piston to the stroke end of the side that will be filled with oil.
2. Open the air bleeder valve on top of the cylinder.
3. If equipped with a stop valve, provide a pilot pressure of approximately 0.2 MPa to the stop valve, and maintain the stop valve in an open position through manual operation or by applying current.

Lubrication

4. Open the oil filler plug to fill with oil. When air no longer comes out intermixed with oil, close the cylinder's air bleeder valve. Make sure that the oil level is near the upper limit mark on the level gauge, and replenish with oil if needed.
5. Next, fill the opposite side with oil. Move the piston to the stroke end of the side that will be filled with oil, and perform steps 1 through 4 in the same sequence as described above.

If the converter is positioned lower than the cylinder:

After filling with oil as described in step 4 above, close the oil filler plug. Then, introduce air pressure of approximately 0.05 MPa into the converter's air port to push the oil into the cylinder. When air no longer comes out intermixed with oil, close the cylinder's air bleeder valve. Perform the remaining steps in the same way as when the converter is located higher than the cylinder, in order to fill it with oil.

* This operation necessarily causes air to accumulate in the cylinder during the operation of the cylinder. Therefore, air must be bled on a regular basis.

Fluid (Hydraulic fluid)

1. Use petroleum based turbine hydraulic operating oil. The use of non-combustible operating oil could lead to problems. An appropriate viscosity is about 40 to 100 St at the operating temperature. Using ISO VG32 oil, the temperature range will be between 15 and 35 °C. To operate in a temperature range that exceeds that of the ISO VG32 oil, use ISO VG46 (25 to 45 °C).

Turbine oil of ISO VG32

(Example) <No additive>

Idemitsu: Turbine oil P32

Nisseki: Turbine oil 32

Maruzen: Turbine oil 32

Mitsubishi: Mitsubishi turbine 32

<Additive>

Idemitsu: Dufny turbine oil

Nisseki: FBK turbine 32

Maruzen: Turbine super 32

Mitsubishi: Diamond turbine oil 32

Air-hydro Converter CCT Series

How to Order



CCT **63** - **100** - Q

● Effective oil level stroke [mm]

● Converter nominal size/stroke [mm]

63	50, 100, 200, 300, 400, 500
100	100, 200, 300, 400, 500, 600
160	200, 300, 400, 500, 600, 700, 800

Specifications

Operating pressure	0 to 0.7 MPa
Proof pressure	1.05 MPa
Ambient and fluid temperature	5 to 50 °C
Fluid	Turbine oil (40 to 100 mm ² /s)

Converter standard effective oil level stroke/effective volume (cm³)

Nominal size [mm]	Standard effective oil level stroke [mm]									Limited flow* (l/min)
	50	100	200	300	400	500	600	700	800	
63	150	300	600	890	1190	1480	—	—	—	36
100	—	750	1510	2260	3010	3770	4520	—	—	88
160	—	—	3660	5490	7320	9150	10980	12810	14640	217

* Limited flow shows the limit of converter of level speed (200 mm/s) which can maintain stability of converter oil level.

Table 1 CE-compliant [mm]

Applicable model	CE marking applicable standard
CCT160-400 to 800	Directive 97/23/EC Category I

CCT40 / Effective oil level stroke

Because the CCT40 is a converter for an actuator with a small capacity, it cannot be made into an air-hydro unit. Instead, use an individual CC valve unit or a speed controller (AS2000, AS3000, AS4000, etc.) through a pipe connection.



Specifications

Operating pressure	0 to 0.7 MPa
Proof pressure	1.05 MPa
Ambient and fluid temperature	5 to 50 °C
Fluid	Turbine oil (40 to 100 mm ² /s)
Nominal size	40 mm

Converter standard effective oil level stroke/effective volume

Standard effective oil level stroke [mm]	50	100	150	200	300
Effective volume [cm ³]	60	120	180	250	370
Limited flow [l/min]	15				

* Limited flow shows the limit of converter of level speed (200 mm/s) which can maintain stability of converter oil level.

CCT Series

Dimensions

CCT63/CCT100/CCT160

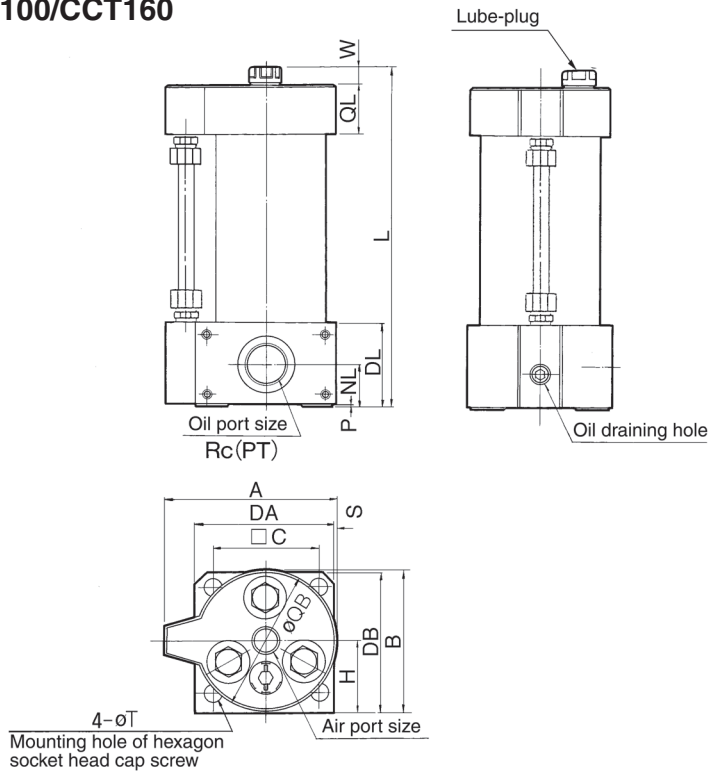

[mm]

Model	Air port size Rc (PT)	Oil port size Rc (PT)	A	B	C	DA	DB	DL	H	NL	P	QB	QL	S	T*	W
CCT63-□	3/8	3/4	104	88	64	86	88	53	45	28	3	86	30	0	11	9.5
CCT100-□	1/2	1	139	125	92	116	123	61	65	33	5	120	32	2	13	7
CCT160-□	3/4	1 1/4	202.5	185	144	180	183	60	93	29	0	185	46	2	20	7

L Dimension

[mm]

Effective oil level stroke	50	100	200	300	400	500	600	700	800
CCT63-□	228.5	278.5	378.5	503.5	603.5	728.5	—	—	—
CCT100-□	—	286	386	511	611	736	836	—	—
CCT160-□	—	—	399	524	624	749	849	949	1049

* Hexagon socket head cap screw is used for mounting.

CCT40

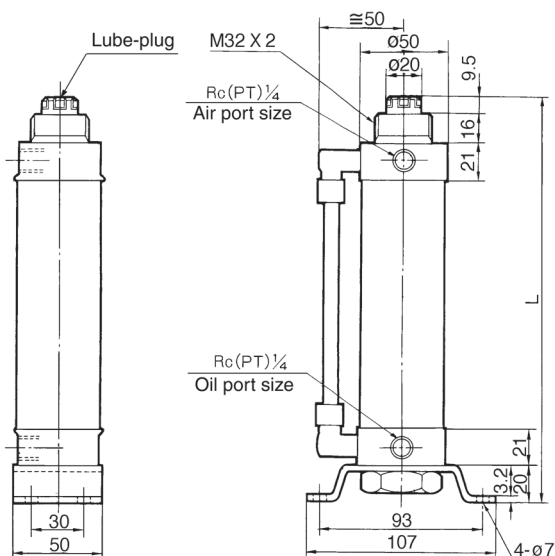

L Dimension

[mm]

Effective oil level stroke	50	100	250	200	300
L	213.5	263.5	313.5	363.5	463.5

If intricate speed control is unnecessary and the changes in speed due to load fluctuations can be tolerated, the pneumatic speed controller can be used as a control valve.

The minimum controllable flow volume of the speed controller is 3l/min.

The speed controller and the converter must have individual pipe connections. They cannot be integrated into a unit.

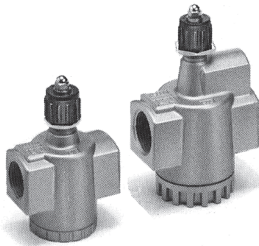

Circuit

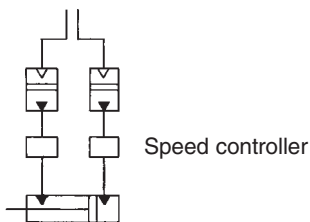

Cylinder Max. Driving Speed (Speed controller)

Conditions: Operating pressure - 0.5 MPa, Operating oil - Turbine oil Class 1 (ISO VG32), Piping length - 1 m

AS420-02, 03, 04

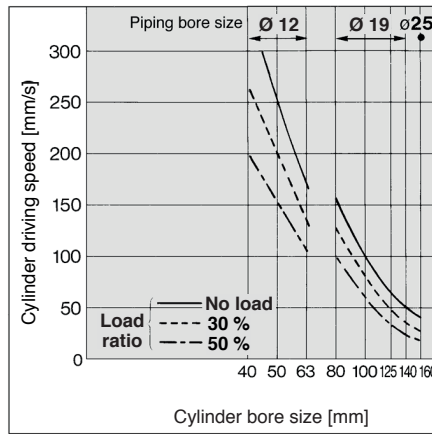

AS500-06

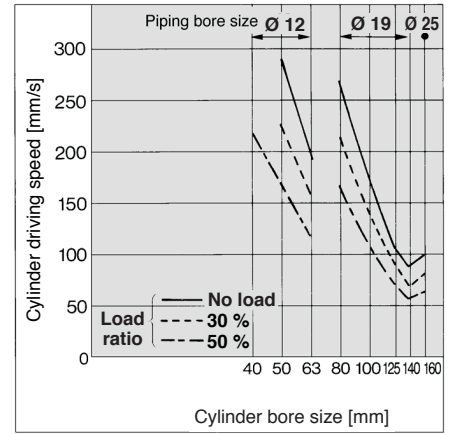

AS600-10

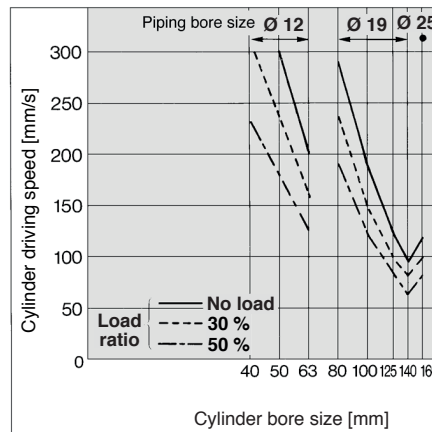

AS2000-01, 02

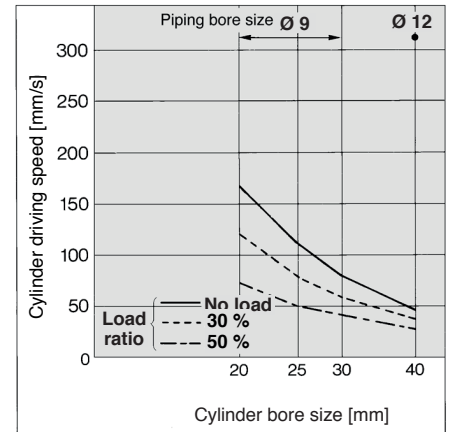

AS3000-02, 03

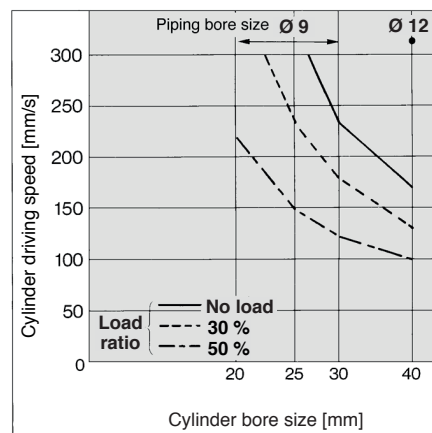

AS4000-02, 03, 04

