

Flow control,  
cartridge restrictor  
Common cavity, Size 12

ST-C-12

OD.21.01 - X - 89

**RE 18321-28**

Edition: 03.2016

Replaces: 01.2011



**Technical data**

Max. operating pressure	350 bar (5000 psi)
Rated flow	150 l/min. (39 gpm)
Fluid temperature range	-30 to 100 °C (-22 to 212 °F)
Installation torque	54 - 66 Nm (40 - 49 ft-lbs)
Weight	0.31 kg (0.68 lbs)
Cavity	CA-12A-2N (see data sheet 18325-70)
Lines bodies and standard assemblies	Please refer to section "Hydraulic integrated circuit" or consult factory
Seal kit <sup>1)</sup>	Code: RG12A2010530100 material no: R930003374
Fluids	Mineral-based or synthetics with lubricating properties at viscosities of 10 to 500 mm <sup>2</sup> /s (cSt)
Recommended degree of fluid contamination	Nominal value max. 10µm (NAS 8) / ISO 4406 19/17/14
Installation	No restrictions
Other Technical Data	See data sheet 18350-50

**Description**

Increasing the orifice value from fully closed to fully open, flow is permitted and regulated bi-directional from 1 to 2 and from 2 to 1. With valve fully closed no leakage permitted between ports 1 and 2.

1) Only external seals for 10 valves

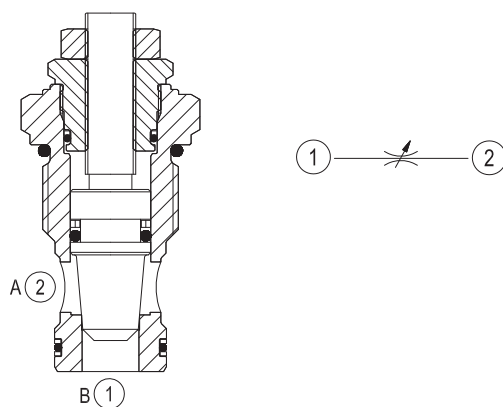

**Characteristic curve**

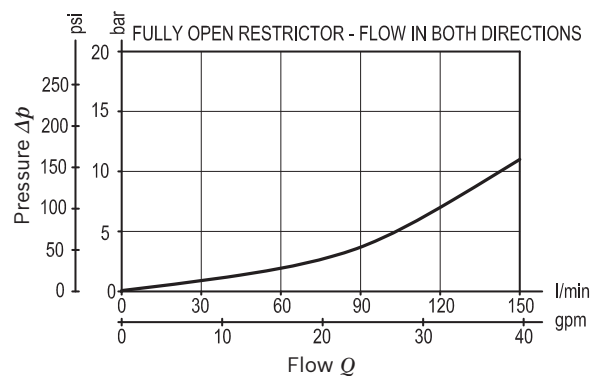

**Ordering code**

<b>OD.21.01</b>	<b>X</b>	<b>89</b>	<b>00</b>	<b>*</b>
-----------------	----------	-----------	-----------	----------

Flow control, cartridge restrictor

Series 0/A to L  
unchanged performances and dimensions

Adjustments

**03** Leakproof hex. socket screw

**04** Handknob and locknut

Version and options standard

**89** Common cavity, Size 12

**Preferred types**

Type	Material number
OD210103890000	R901109832
OD210104890000	R901109834

Type	Material number

**Dimensions**

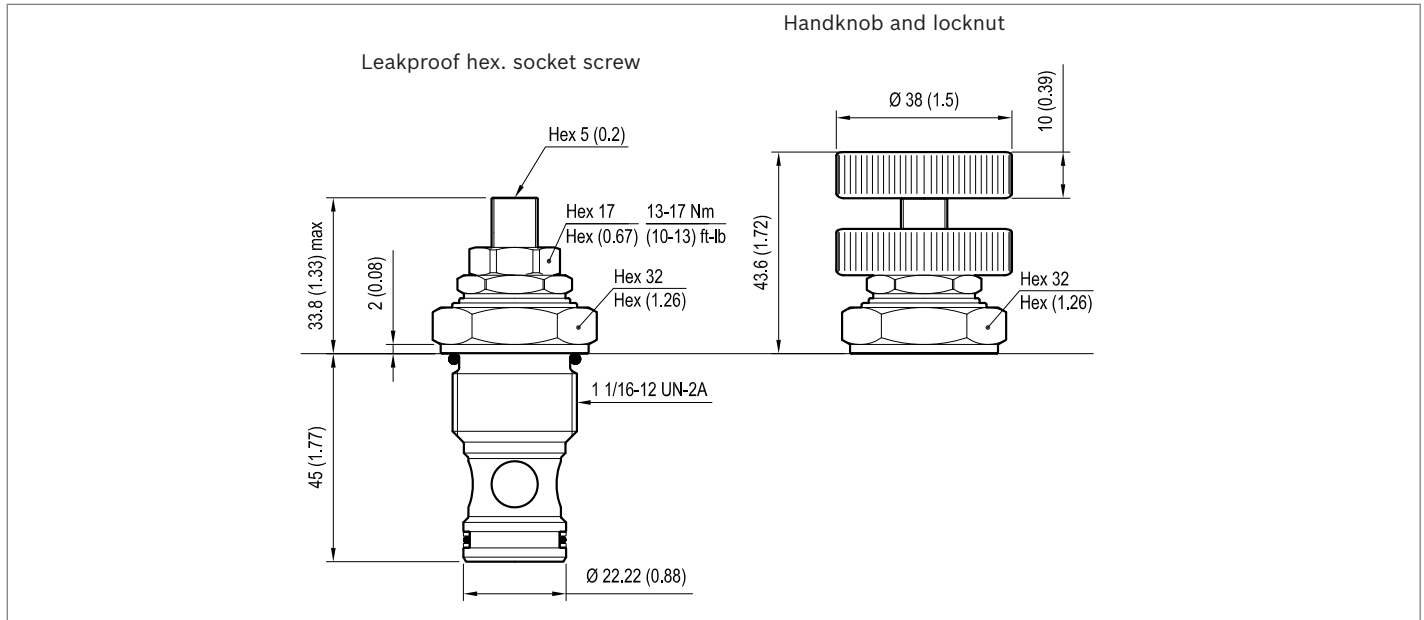

**Bosch Rexroth Oil Control S.p.A.**

Via Leonardo da Vinci 5  
P.O. Box no. 5  
41015 Nonantola – Modena, Italy  
Tel. +39 059 887 611  
Fax +39 059 547 848  
compact-hydraulics-cv@boschrexroth.com  
www.boschrexroth.com/compacthydraulics

© This document, as well as the data, specifications and other information set forth in it, are the exclusive property of Bosch Rexroth Oil Control S.p.a.. It may not be reproduced or given to third parties without its consent. The data specified above only serve to describe the product. No statements concerning a certain condition or suitability for a certain application can be derived from our information. The information given does not release the user from the obligation of own judgment and verification. It must be remembered that our products are subject to a natural process of wear and aging. Subject to change.