

Check, poppet reverse type

Common cavity, Size 12

VURN-12A

04.31.36.00.57 - Z

RE 18318-98

Edition: 03.2016

Replaces: 09.2009



Technical data

Max. operating pressure	350 bar (5000 psi)
Max. flow	90 l/min (24 gpm)
Max. internal leakage	5 drops/min.
Fluid temperature range	-30 to 100 °C (-22 to 212 °F)
Installation torque	81 - 95 Nm (60 - 70 ft-lbs)
Weight	0.2 kg (0.44 lbs)
Cavity	CA-12A-2N (see data sheet 18325-70)
Lines bodies and standard assemblies	Please refer to section "Hydraulic integrated circuit" or consult factory
Seal kit ¹⁾	Code: RG12A2010520100 material no: R901111377
Fluids	Mineral-based or synthetics with lubricating properties at viscosities of 5 to 800 mm ² /s (cSt)
Recommended degree of fluid contamination	Nominal value max. 10µm (NAS 8) / ISO 4406 19/17/14
Installation position	No restrictions
Other Technical Data	See data sheet 18350-50

Description

When pressure at 2 rises above the spring bias pressure, the poppet is pushed from its seat and flow is allowed from 2 to 1. The valve is closed (checked) from 1 to 2. Precision machining and hardening processes allow virtually leak-free performance in the checked condition.

1) Only external seals for 10 valves

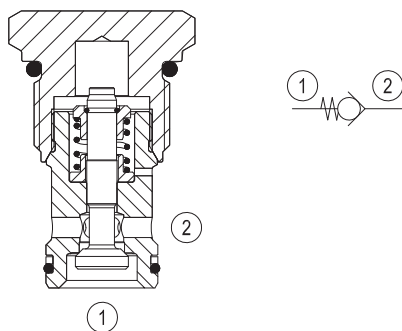

Characteristic curve

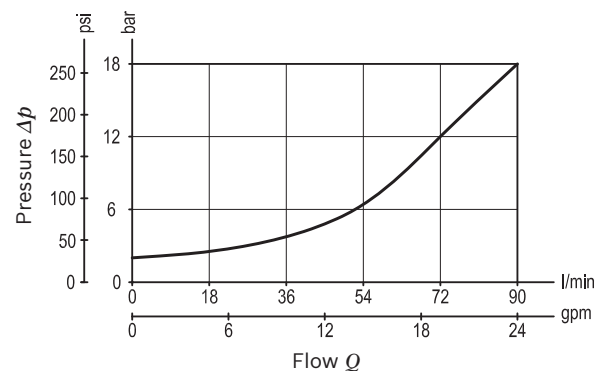

Ordering code

04.31.36.00	57	Z	00	*
--------------------	-----------	----------	-----------	----------

Check, poppet reverse type

57 Common cavity, Size 12

Series 0/A to L
unchanged performances and dimensions

Version and options standard

SPRINGS	
Cracking pressure bar (psi)	
02	2 (30)

Preferred types

Type	Material number
043136005702000	R930000502

Type	Material number
------	-----------------

Dimensions

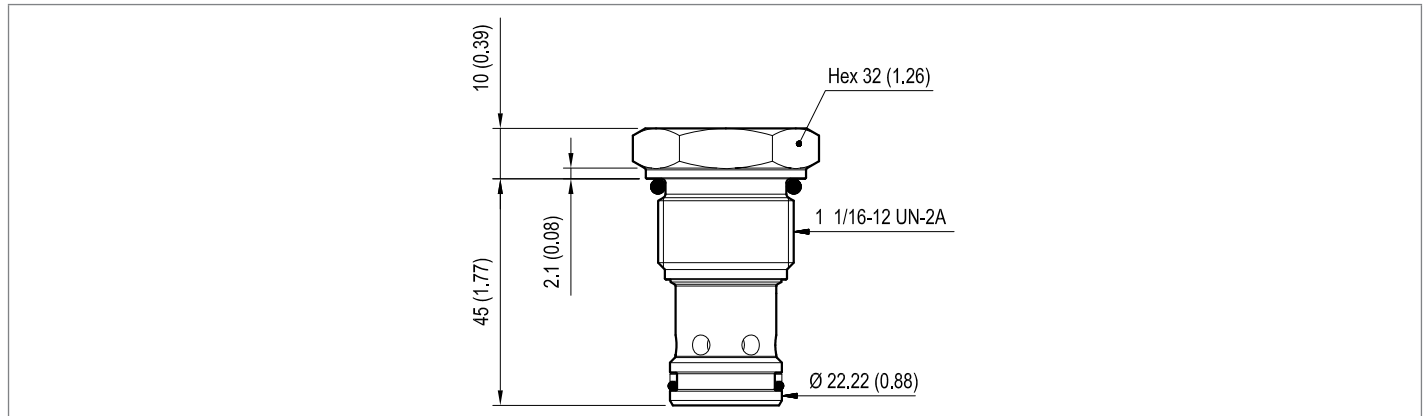

Bosch Rexroth Oil Control S.p.A.

Via Leonardo da Vinci 5
P.O. Box no. 5
41015 Nonantola – Modena, Italy
Tel. +39 059 887 611
Fax +39 059 547 848
compact-hydraulics-cv@boschrexroth.com
www.boschrexroth.com/compacthydraulics

© This document, as well as the data, specifications and other information set forth in it, are the exclusive property of Bosch Rexroth Oil Control S.p.a.. It may not be reproduced or given to third parties without its consent. The data specified above only serve to describe the product. No statements concerning a certain condition or suitability for a certain application can be derived from our information. The information given does not release the user from the obligation of own judgment and verification. It must be remembered that our products are subject to a natural process of wear and aging. Subject to change.